

34 KG

23 Judoka

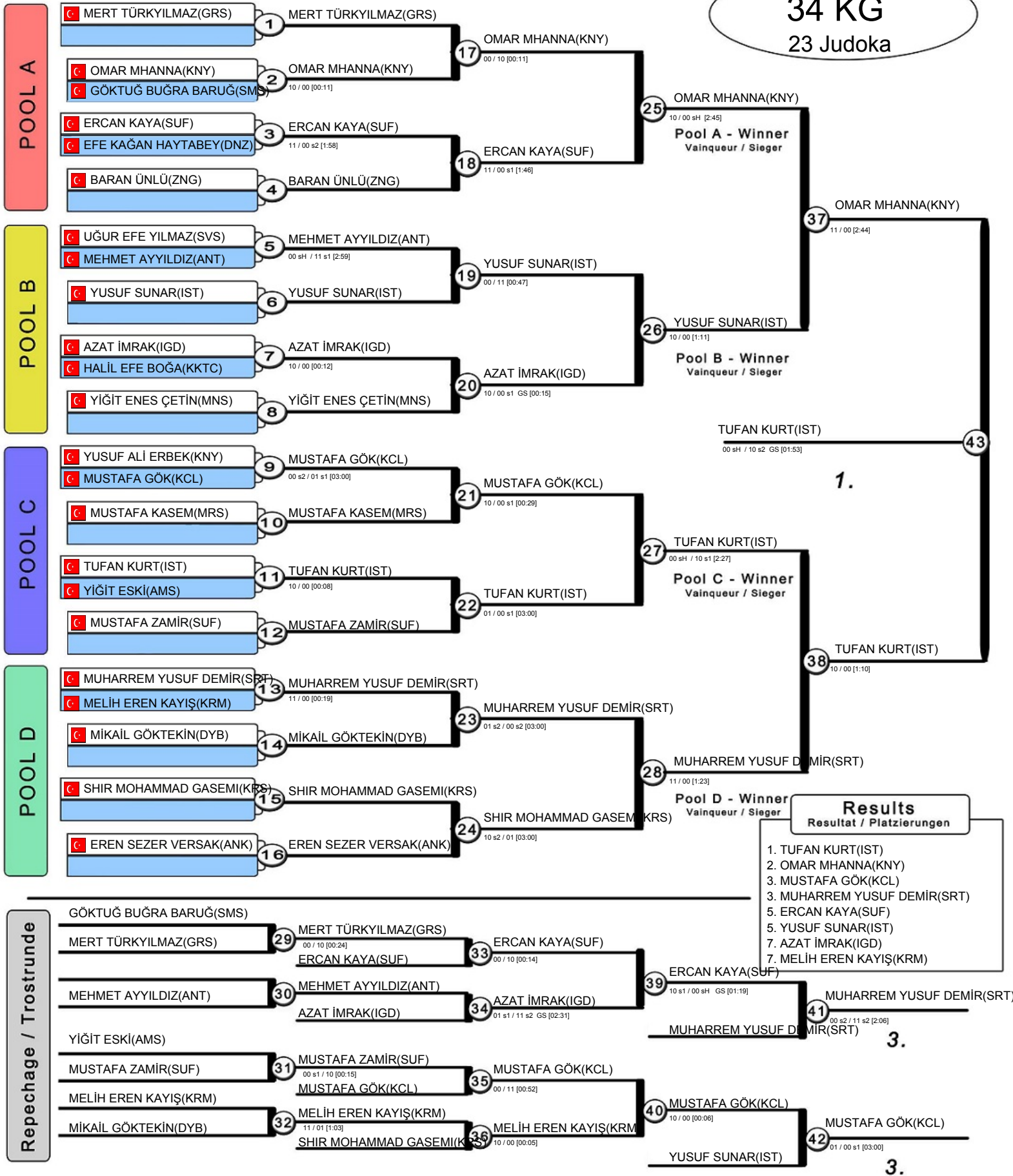

38 KG

24 Judoka

POOL A

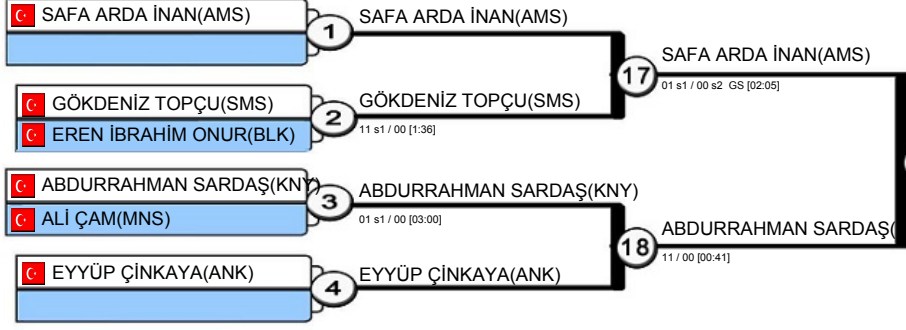

Pool A - Winner
Vainqueur / Sieger

POOL B

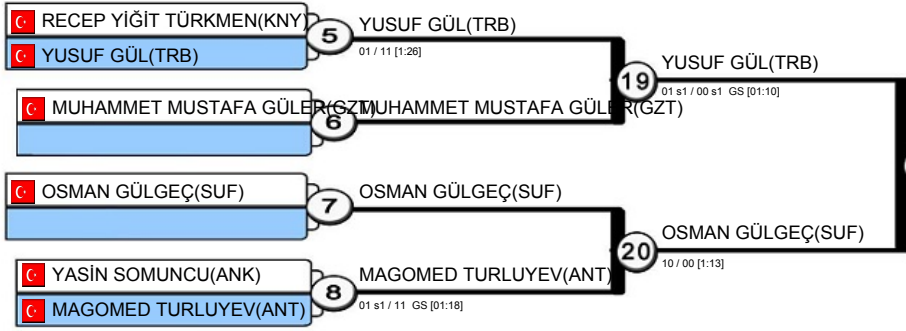

Pool B - Winner
Vainqueur / Sieger

POOL C

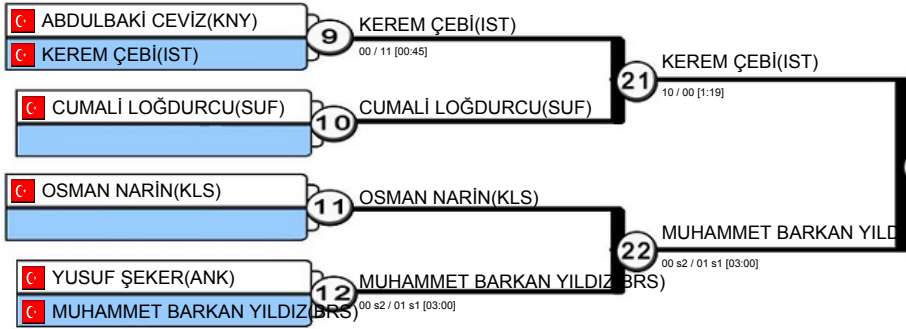

Pool C - Winner
Vainqueur / Sieger

POOL D

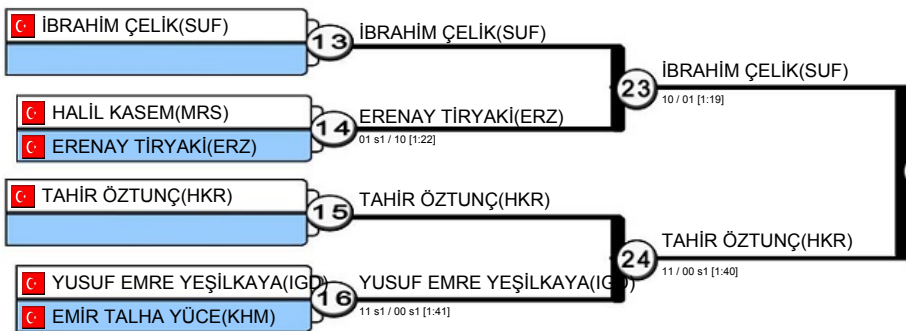

Pool D - Winner
Vainqueur / Sieger

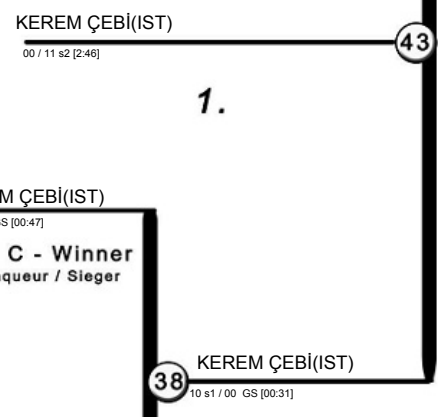

1.

38
10 s1 / 00 GS [00:31]

Results
Resultat / Platzierungen

1. KEREM ÇEBİ(IST)
2. SAFA ARDA İNAN(AMS)
3. CUMALI LOĞDURCU(SUF)
3. TAHİR ÖZTUNÇ(HKR)
5. GÖKDENİZ TOPÇU(SMS)
5. OSMAN GÜLGEÇ(SUF)
7. İBRAHİM ÇELİK(SUF)

Repechage / Trostrunde

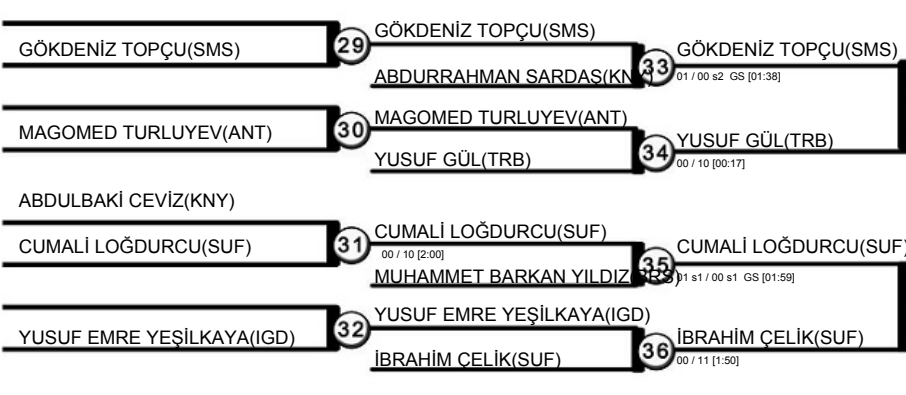

3.

3.

42 KG

23 Judoka

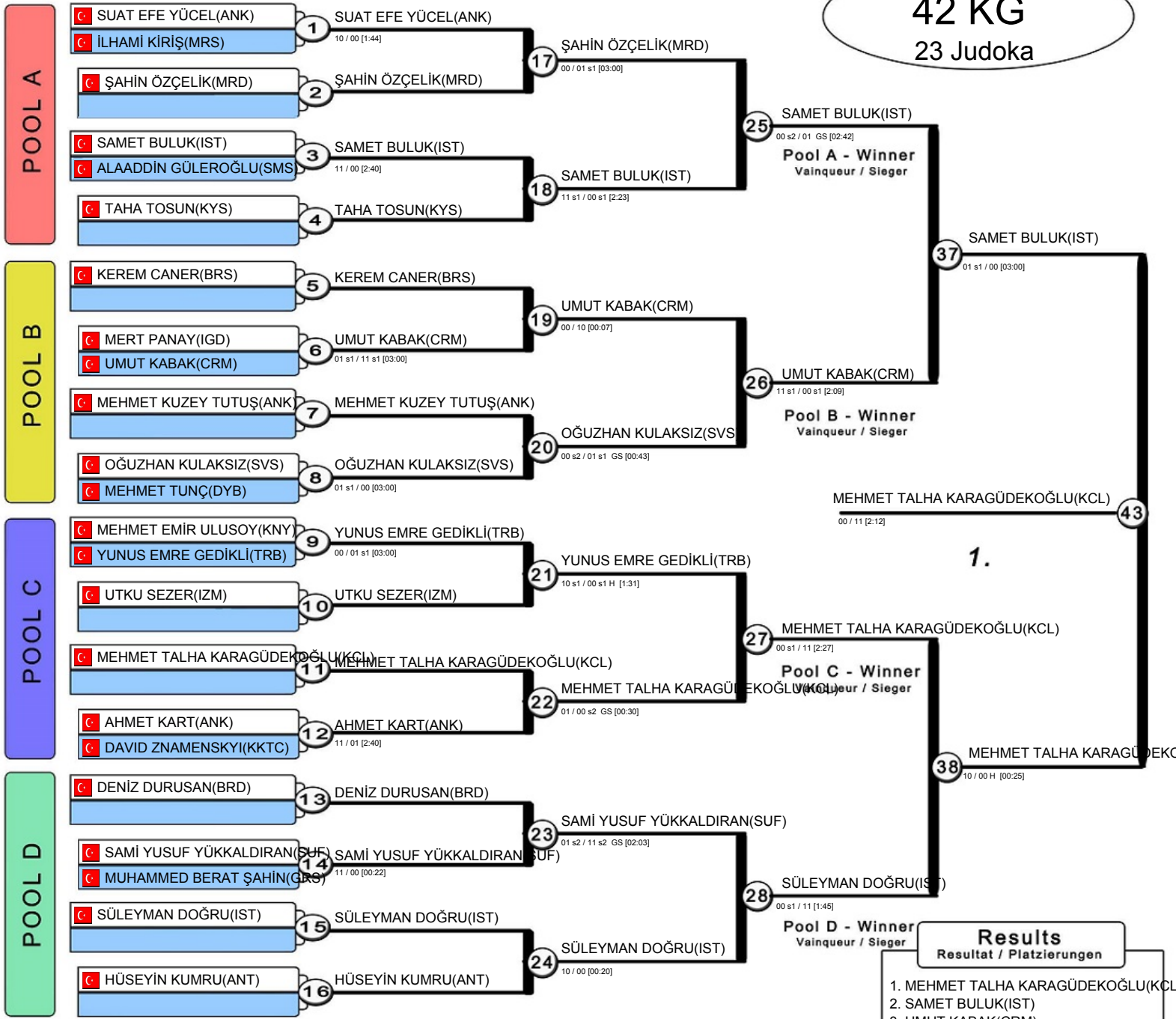

Results
Resultat / Platzierungen

1. MEHMET TALHA KARAGÜDEKOĞLU(KCL)
2. SAMET BULUK(IST)
3. UMUT KABAK(CRM)
3. SÜLEYMAN DOĞRU(IST)
5. ŞAHİN ÖZÇELİK(MRD)
5. AHMET KART(ANK)
7. MERT PANAY(IGD)
7. SAMİ YUSUF YÜKKALDIRAN(SUF)

46 KG

23 Judoka

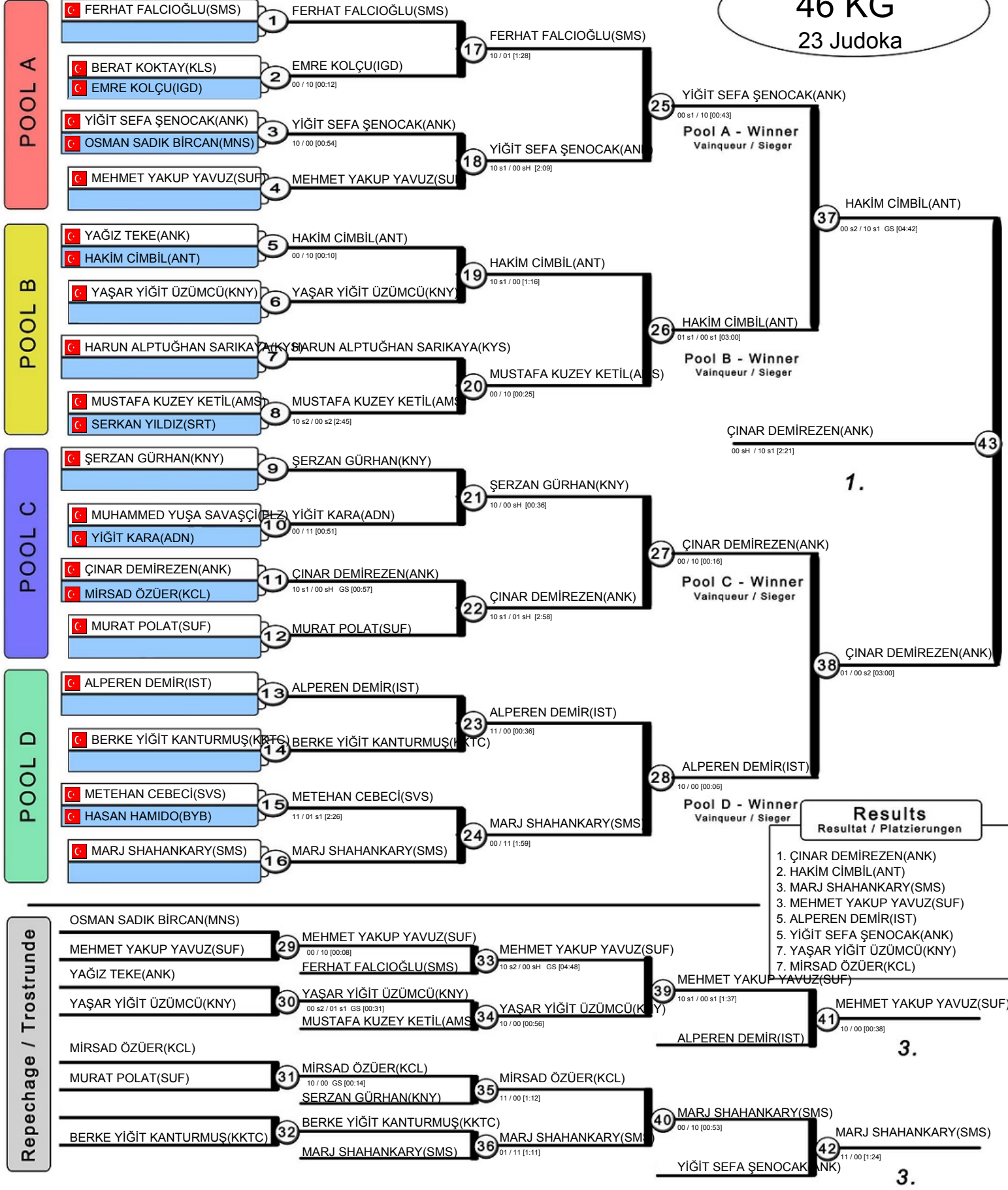

50 KG

23 Judoka

POOL A

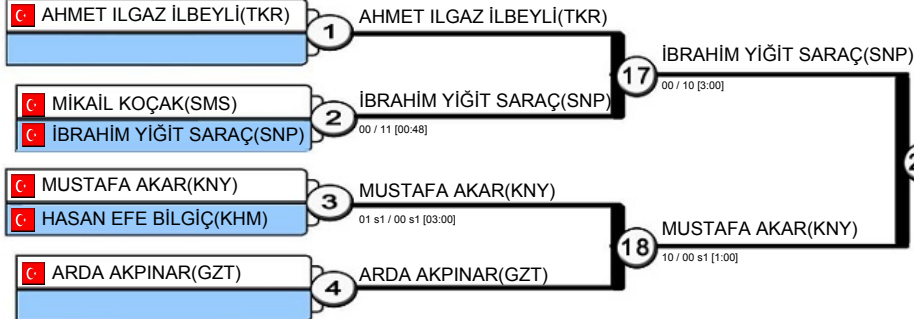

POOL B

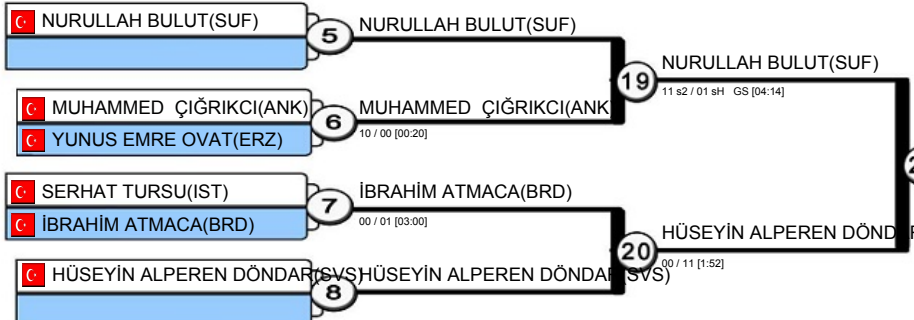

POOL C

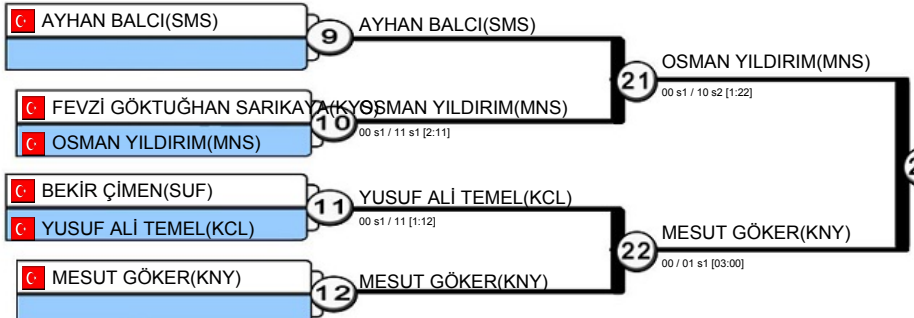

POOL D

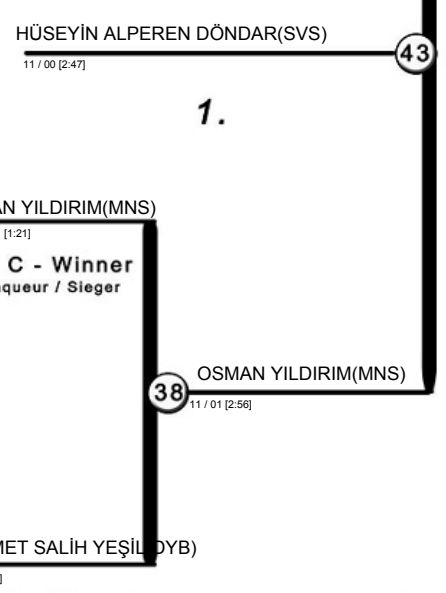
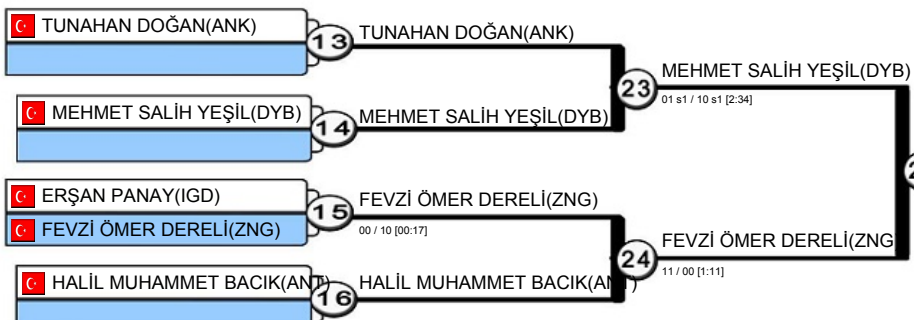

- Results**
Resultat / Platzierungen
- HÜSEYİN ALPEREN DÖNDAR(SVS)
 - OSMAN YILDIRIM(MNS)
 - İBRAHİM YİĞİT SARAÇ(SNP)
 - İBRAHİM ATMACA(BRD)
 - MEHMET SALİH YEŞİL(DYB)
 - AYHAN BALCI(SMS)
 - FEVZİ ÖMER DERELİ(ZNG)
 - MUSTAFA AKAR(KNY)

Repechage / Trostrunde

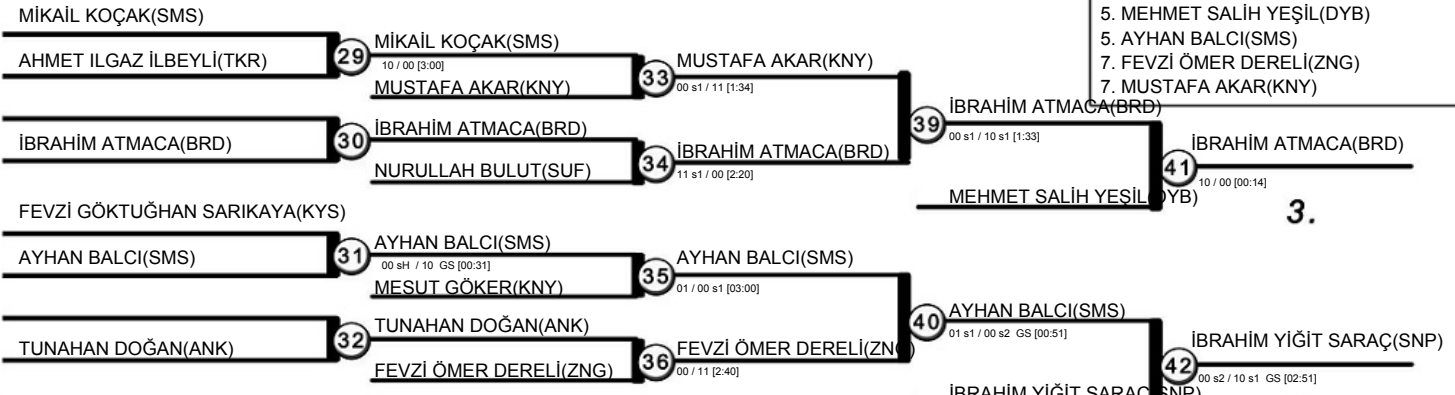

55 KG

24 Judoka

POOL A

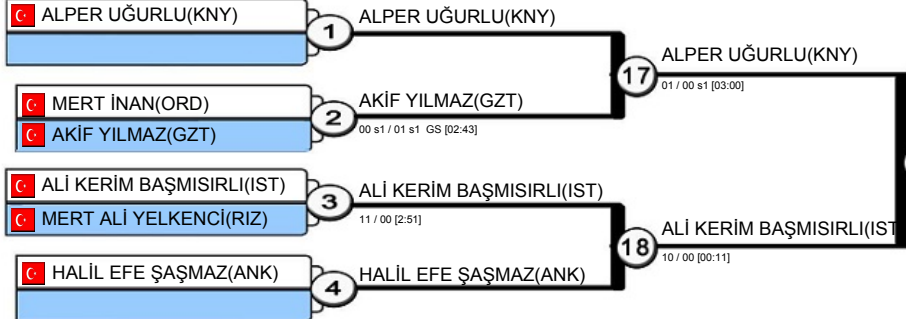

POOL B

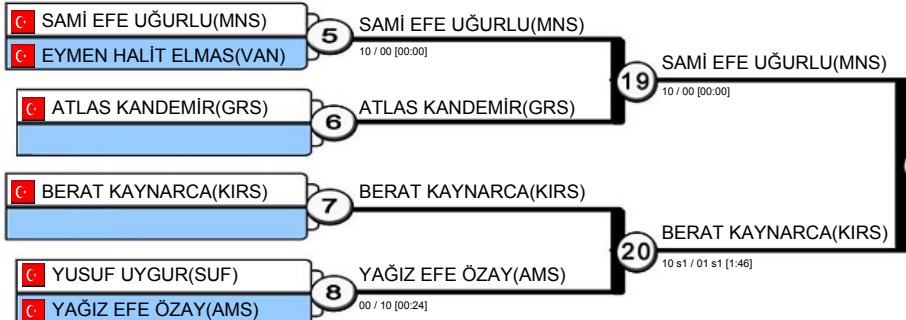

POOL C

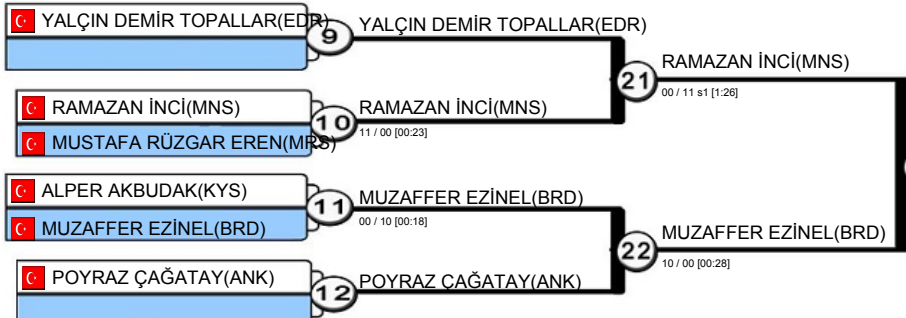

POOL D

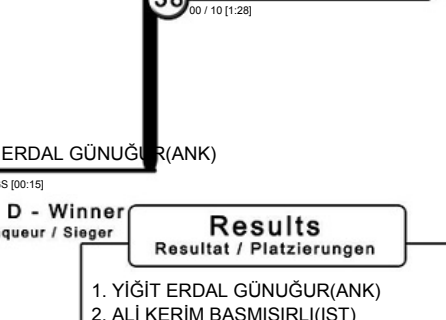
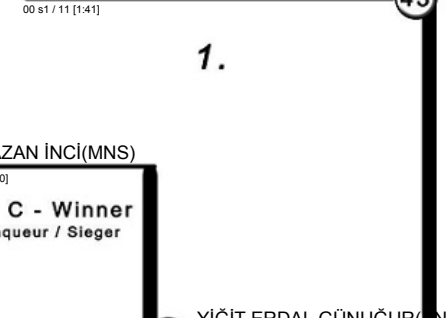
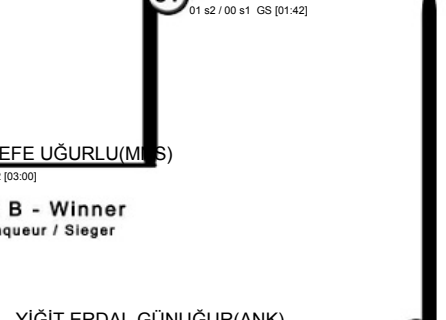
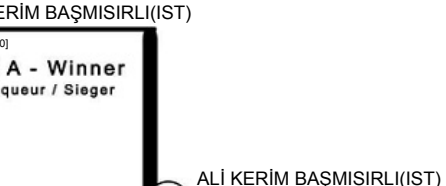
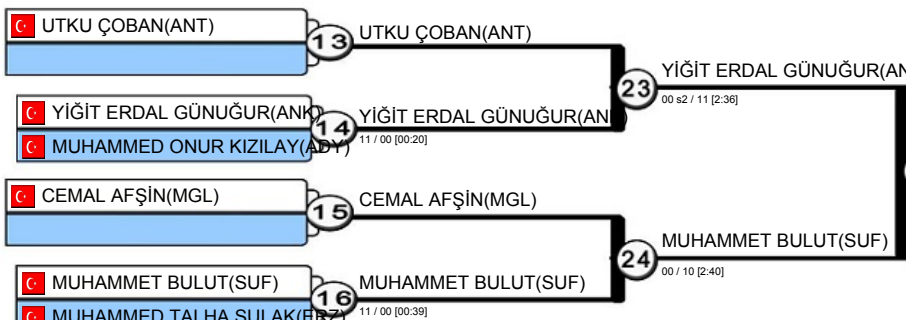

1.

3.

3.

3.

3.

Results
Resultat / Platzierungen

1. YİĞİT ERDAL GÜNUĞUR(ANK)
2. ALİ KERİM BAŞMISIRLI(IST)
3. MUZAFFER EZİNEL(BRD)
3. RAMAZAN İNCİ(MNS)
5. MERT ALİ YELKENCİ(RIZ)
5. SAMİ EFE UĞURLU(MNS)
7. MUHAMMET BULUT(SUF)
7. BERAT KAYNARCA(KIRS)

Repechage / Trostrunde

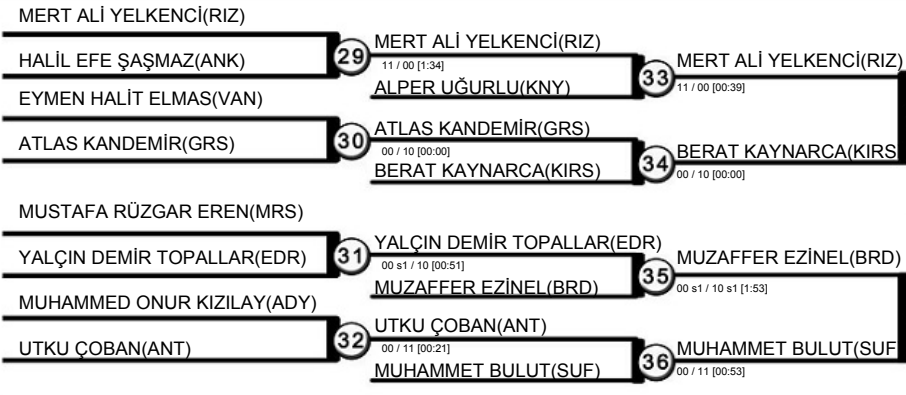

60 KG
22 Judoka

POOL A

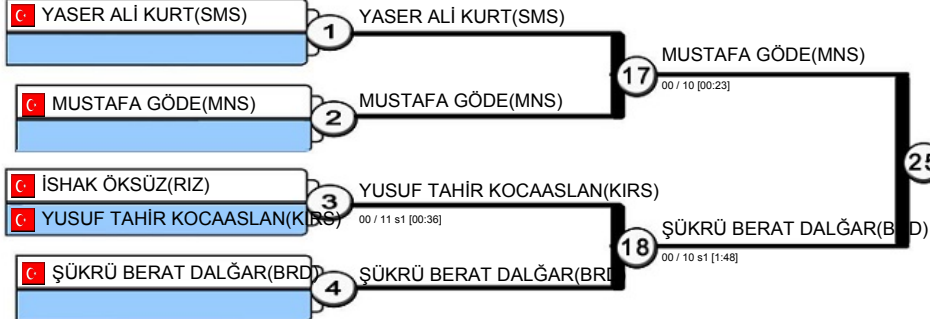

POOL B

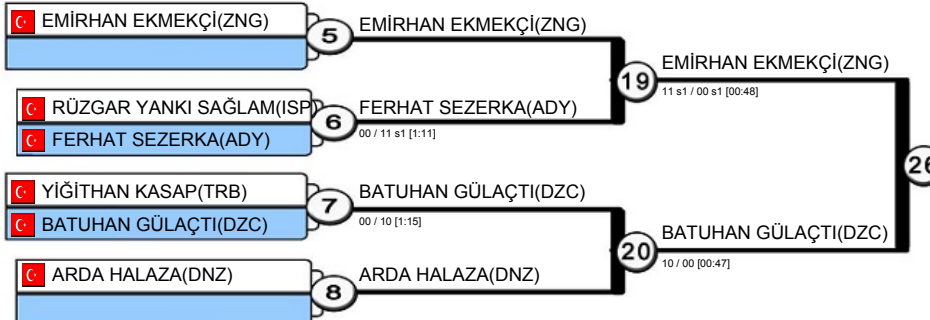

POOL C

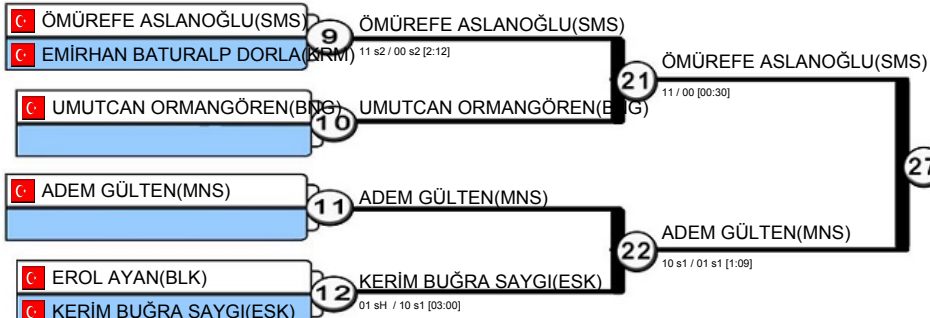

POOL D

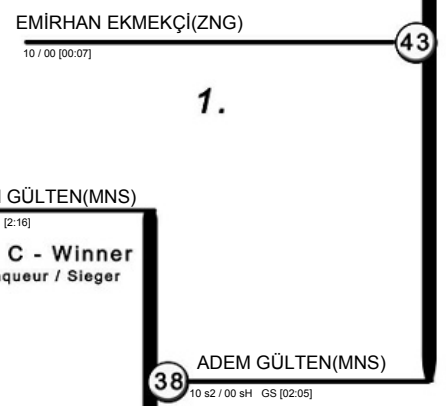
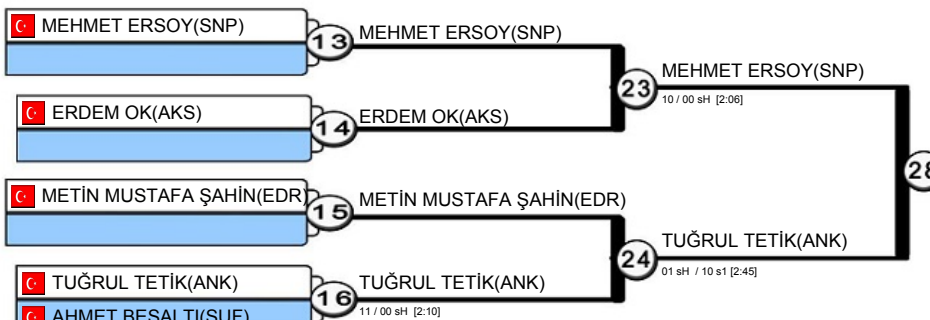

1.

2.

3.

Results
Resultat / Platzierungen

1. EMİRHAN EKMEKÇİ(ZNG)
2. ADEM GÜLTEN(MNS)
3. ŞÜKRÜ BERAT DALĞAR(BRD)
4. TUĞRUL TETİK(ANK)
5. YUSUF TAHİR KOCAASLAN(KIRS)
6. METİN MUSTAFA ŞAHİN(EDR)
7. ÖMÜREFE ASLANOĞLU(SMS)
8. BATUHAN GÜLAÇTI(DZC)

Repechage / Trostrunde

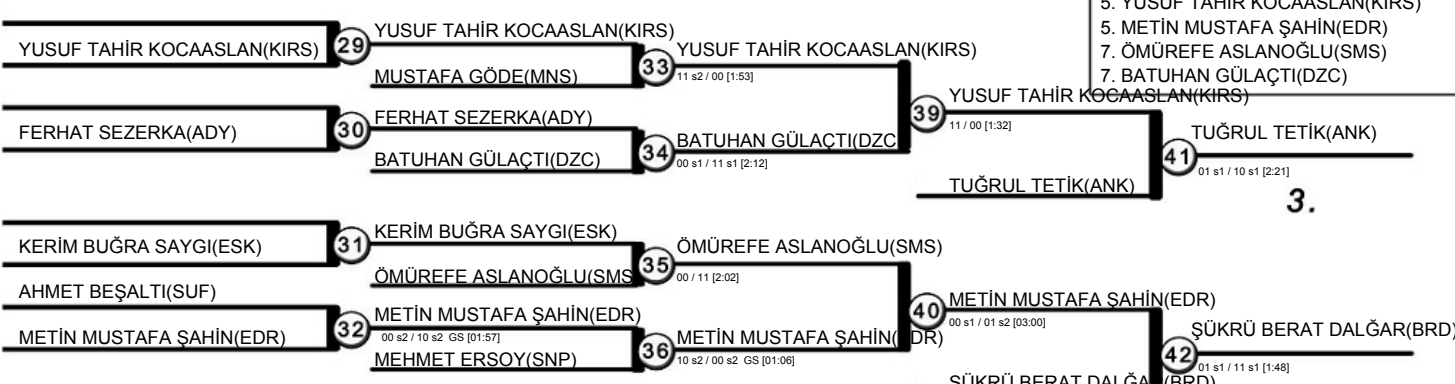

3.

3.

66 KG

21 Judoka

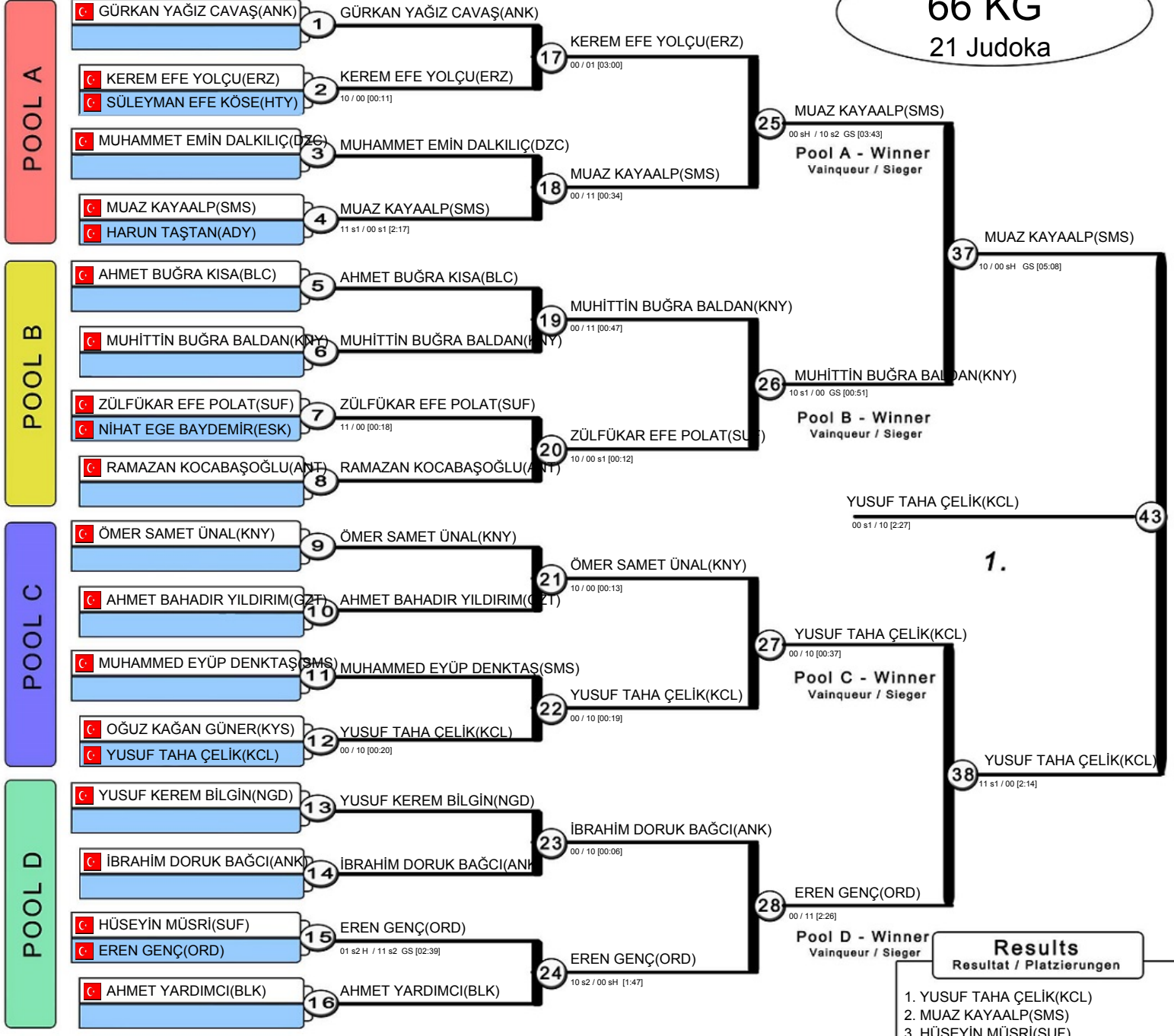

Results
Resultat / Platzierung

1. YUSUF TAHA ÇELİK (KCL)
2. MUAZ KAYAALP (SMS)
3. HÜSEYİN MÜSRİ (SUF)
3. EREN GENÇ (ORD)
5. ZÜLFÜKAR EFE POLAT (SUF)
6. MUHİTTİN BUĞRA BALDAN (KNY)
7. ÖMER SAMET ÜNAL (KNY)
7. MUHAMMET EMİN DALKILIÇ (DZC)



+66 KG
22 Judoka

POOL A

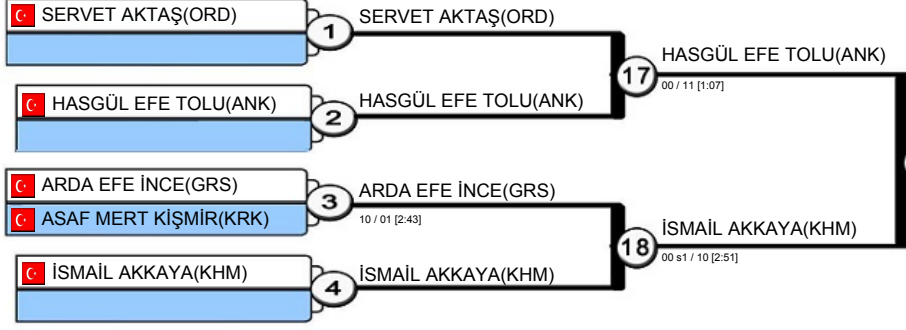

POOL B

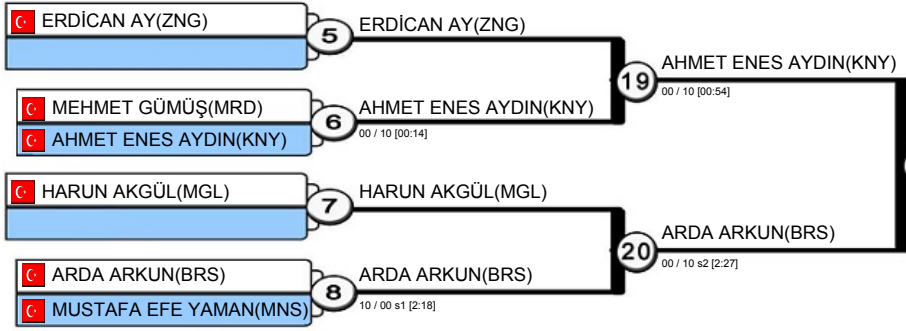

POOL C

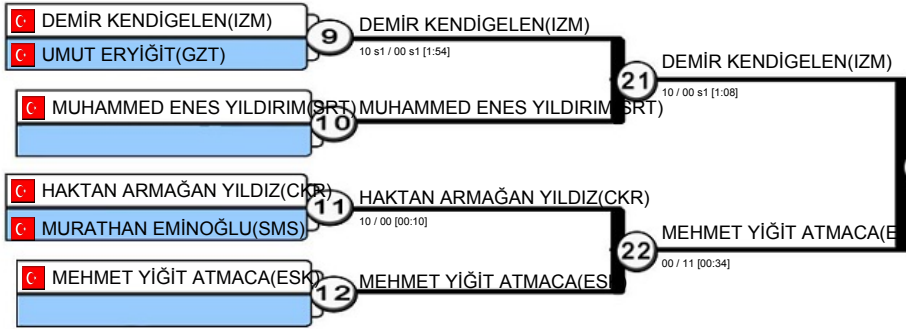

POOL D

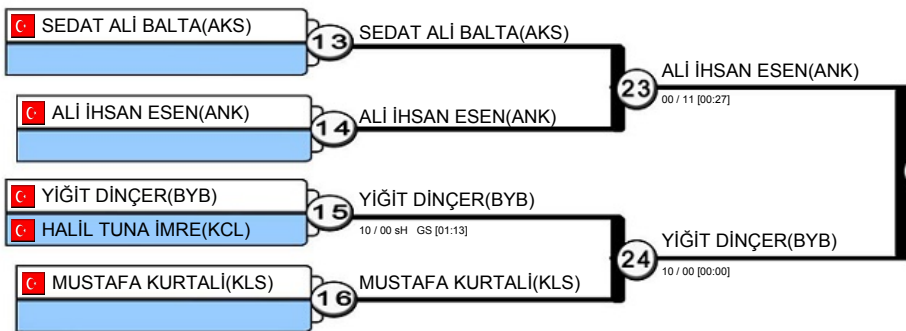

Results
Resultat / Platzierungen

- AHMET ENES AYDIN(KNY)
- ALİ İHSAN ESEN(ANK)
- YİĞİT DİNÇER(BYB)
- ERDİCAN AY(ZNG)
- DEMİR KENDİGELEN(IZM)
- İSMAİL AKKAYA(KHM)
- ARDA EFE İNCE(GRS)
- MEHMET YİĞİT ATMACA(ESK)

Repechage / Trostrunde

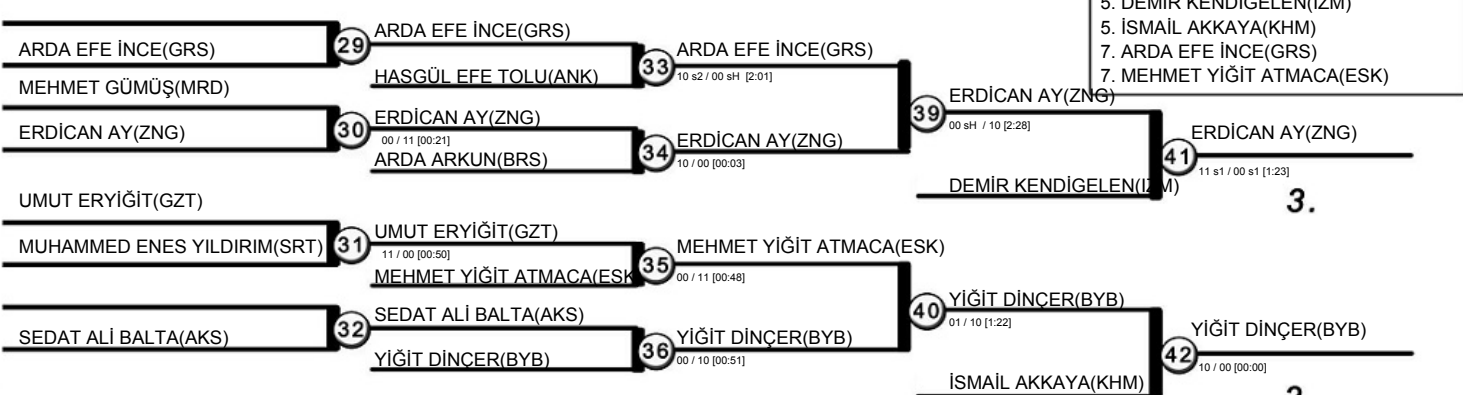

32 KG

23 Judoka

POOL A

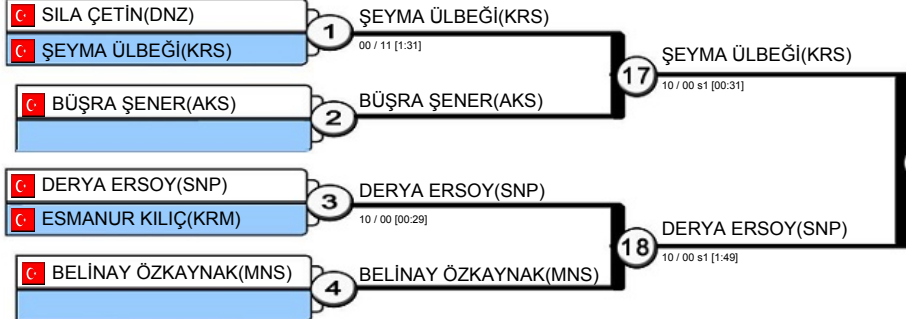

POOL B

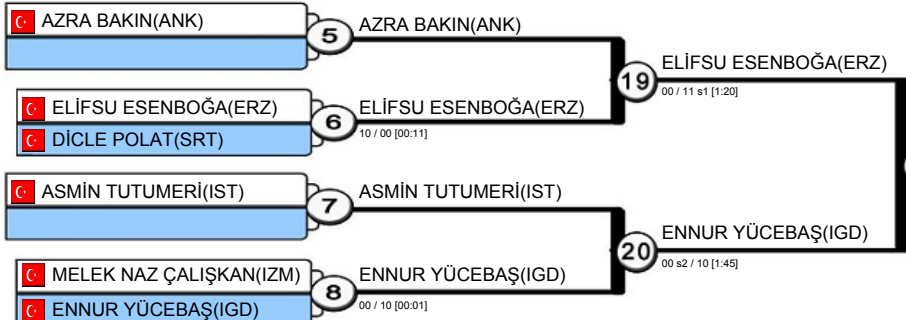

POOL C

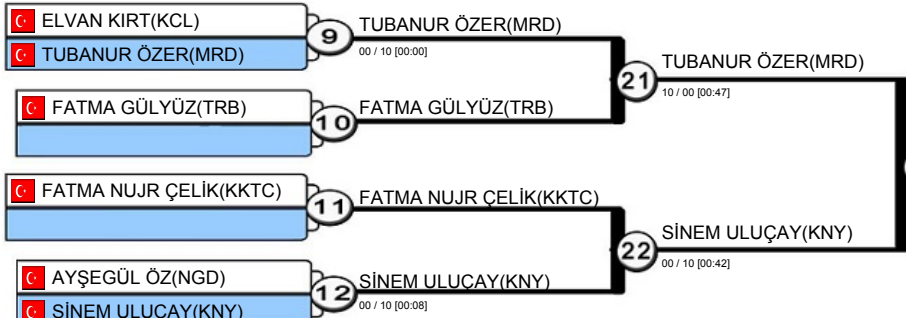

POOL D

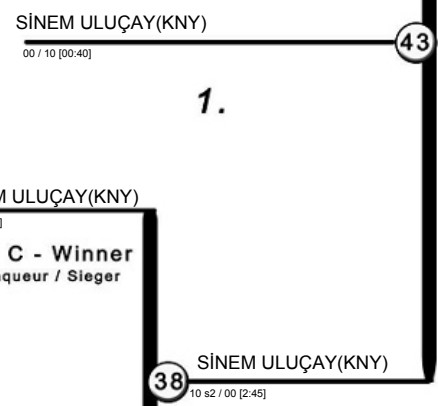
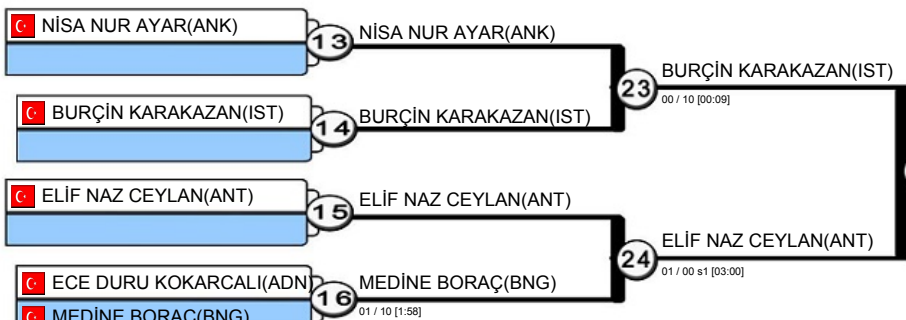

1.

Pool C - Winner
Vainqueur / Sieger

Pool D - Winner
Vainqueur / Sieger

Results
Resultat / Platzierungen

1. SİNEM ULUÇAY(KNY)
2. ŞEYMA ÜLBEĞİ(KRS)
3. ELİF NAZ CEYLAN(ANT)
3. BURÇİN KARAKAZAN(IST)
5. ENNUR YÜCEBAŞ(IGD)
5. ELİFSU ESENBOĞA(ERZ)
7. TUBANUR ÖZER(MRD)
7. DERYA ERSOY(SNP)

Repechage / Trostrunde

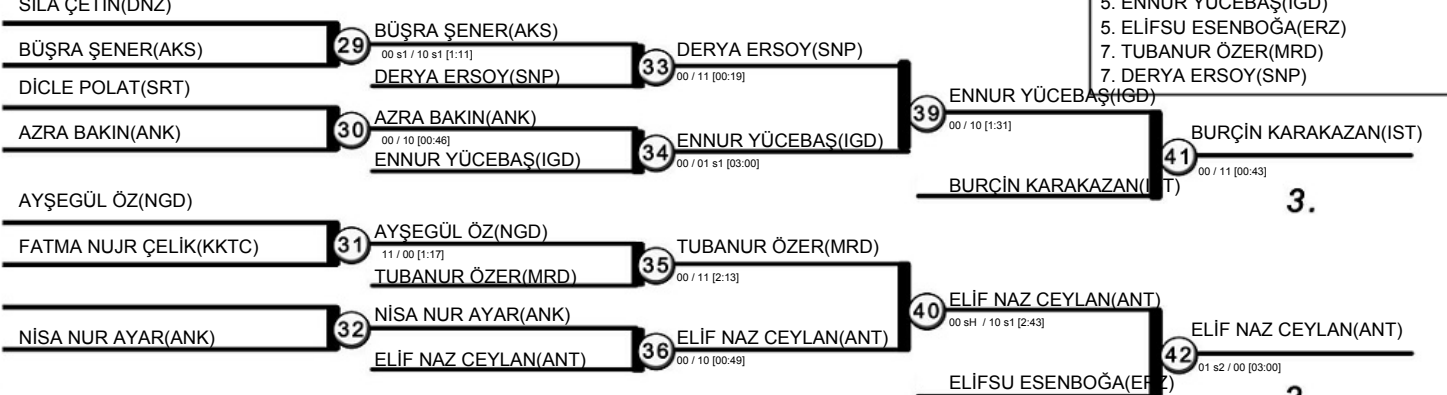

3.

3.

36 KG

23 Judoka

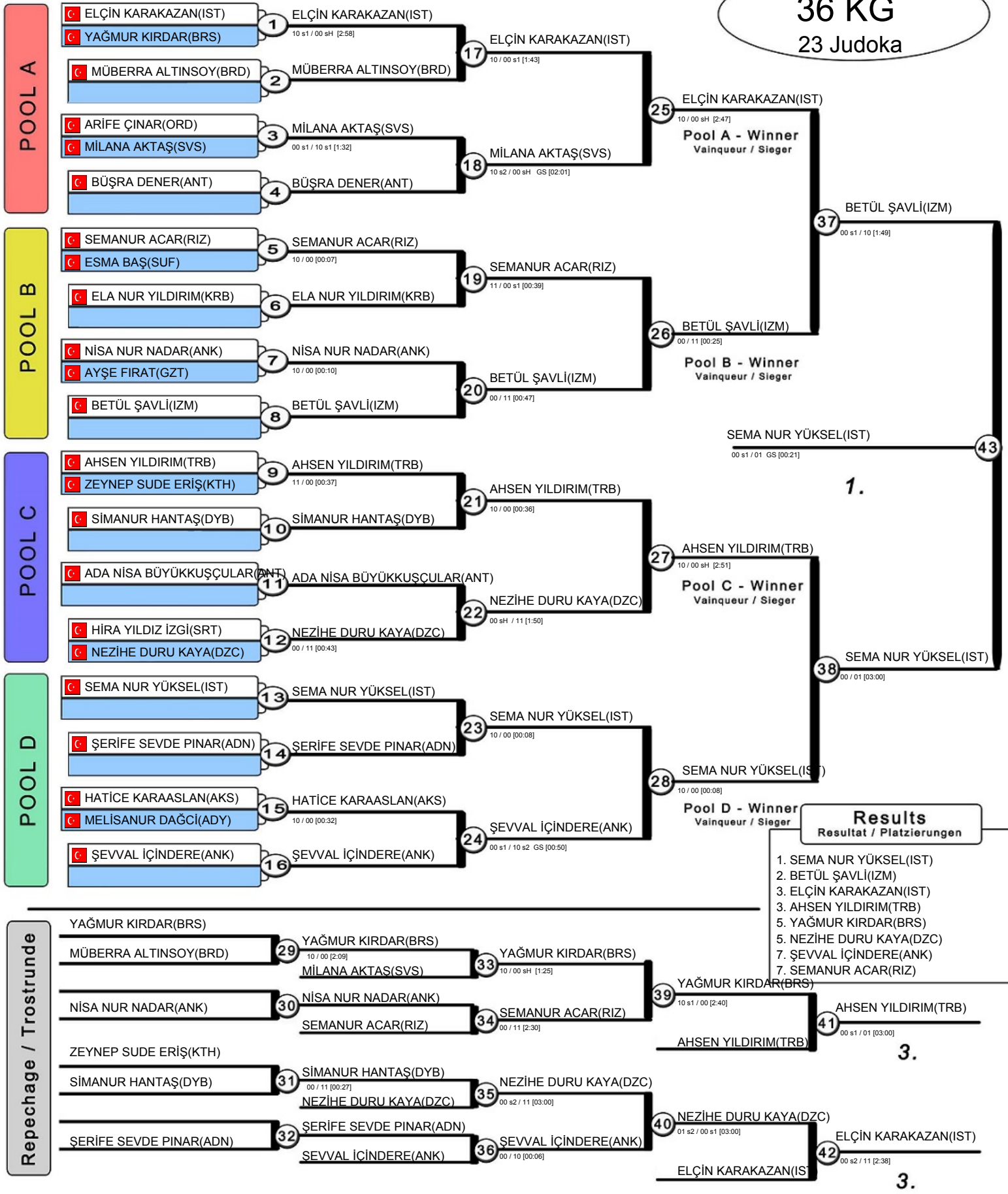

40 KG

23 Judoka

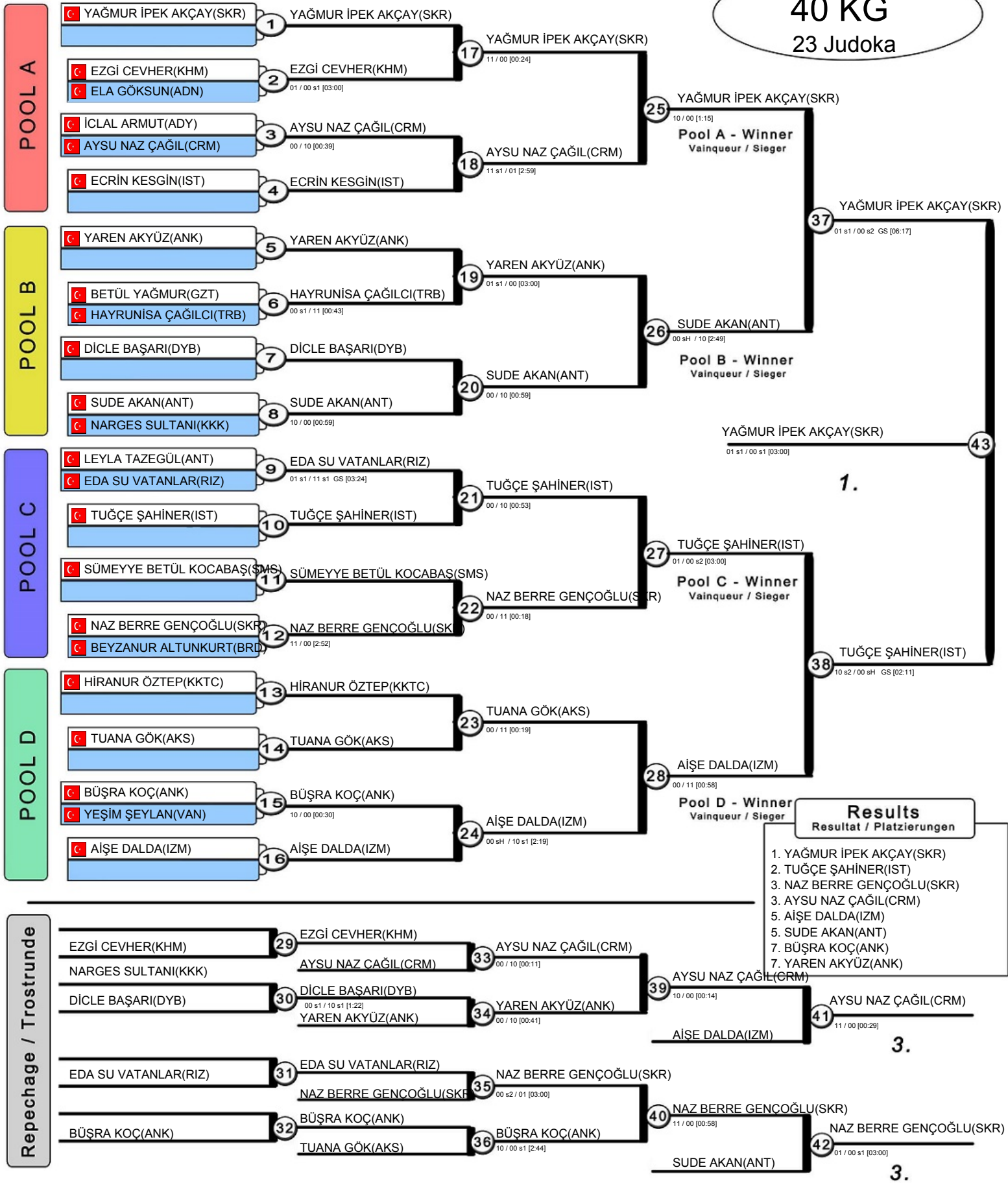

44 KG

24 Judoka

POOL A

C AHSEN GÜCÜ(IZM)	1	ESİLA ÇORBACI(SMS)	01 / 11 [2:07]	17	BÜŞRA BİRLEŞİK(IST)	00 / 10 s1 [2:39]
C ESİLA ÇORBACI(SMS)						
C BÜŞRA BİRLEŞİK(IST)	2	BÜŞRA BİRLEŞİK(IST)		25	ROJİN KARABOĞA(DZC)	00 / 10 s2 GS [01:05]
C ROJİN KARABOĞA(DZC)						
C NİSA NUR ÇİFTYILDIZ(RIZ)	3	ROJİN KARABOĞA(DZC)	01 / 00 s2 [03:00]	18	ROJİN KARABOĞA(DZC)	10 / 00 [00:18]
C KARDELEN ŞEVAL KIRÖMEROĞLU(KRS)	4	KARDELEN ŞEVAL KIRÖMEROĞLU(KRS)				

Pool A - Winner
Vainqueur / Sieger

POOL B

C ŞERİFE GÜNEYTEPE(ANT)	5	ARİFE AYDINOĞLU(DNZ)	00 s1 / 11 [2:51]	19	ARİFE AYDINOĞLU(DNZ)	10 / 00 [1:48]
C ARİFE AYDINOĞLU(DNZ)						
C CEREN FATMA URAL(MRS)	6	CEREN FATMA URAL(MRS)		26	MİRAY PEKTAŞ(AMS)	00 sH / 10 s1 GS [03:30]
C MİRAY PEKTAŞ(AMS)	7	MİRAY PEKTAŞ(AMS)				
C AYŞEGÜL BERRAK AKTAN(ANK)	8	BEYZANUR AKYURT(AKS)	00 / 10 [00:00]	20	MİRAY PEKTAŞ(AMS)	11 / 00 s2 [2:21]
C BEYZANUR AKYURT(AKS)						

Pool B - Winner
Vainqueur / Sieger

POOL C

C FATMA ASU TAKIL(SUF)	9	ZELAL DÖLEK(MRD)	00 / 11 [00:17]	21	ZELAL DÖLEK(MRD)	11 / 01 [1:26]
C ZELAL DÖLEK(MRD)						
C HANİFE MELİS KARAKUŞ(ORD)	10	HANİFE MELİS KARAKUŞ(ORD)		27	PAKİZE GÜL DURAN(ANT)	00 / 10 [00:44]
C PAKİZE GÜL DURAN(ANT)	11	PAKİZE GÜL DURAN(ANT)	10 / 00 [00:38]	22	PAKİZE GÜL DURAN(ANT)	10 / 00 s1 [00:38]
C MARIHA GÜL DEMİR(KCL)						
C BURÇİN POLAT(ANK)	12	BURÇİN POLAT(ANK)				

Pool C - Winner
Vainqueur / Sieger

POOL D

C RUMEYSA ALMAZ(VAN)	13	RUMEYSA ALMAZ(VAN)		23	FATİMA ZEHRA TURAN(SVS)	00 / 10 [00:30]
C FATİMA ZEHRA TURAN(SVS)	14	FATİMA ZEHRA TURAN(SVS)	10 / 00 sH [2:13]	28	FATİMA ZEHRA TURAN(SVS)	11 / 00 s1 [2:49]
C KARDELEN BEBEK(KKTC)						
C AYŞENUR GÜNEŞ(MLT)	15	NEHİR ÖZDEMİR(KIRS)	01 s1 / 10 [2:03]	24	İLAYDA KURT(IST)	00 s2 / 11 [1:50]
C NEHİR ÖZDEMİR(KIRS)						
C İLAYDA KURT(IST)	16	İLAYDA KURT(IST)				

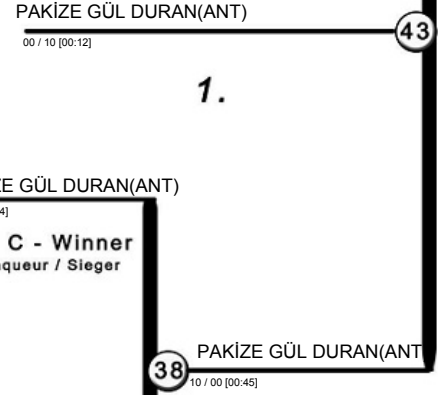
Pool D - Winner
Vainqueur / SiegerResults
Resultat / Platzierungen

1. PAKİZE GÜL DURAN(ANT)
2. MİRAY PEKTAŞ(AMS)
3. İLAYDA KURT(IST)
3. BÜŞRA BİRLEŞİK(IST)
5. FATİMA ZEHRA TURAN(SVS)
5. ROJİN KARABOĞA(DZC)
7. MARIHA GÜL DEMİR(KCL)
7. ARİFE AYDINOĞLU(DNZ)

Repechage / Trostrunde

NİSA NUR ÇİFTYILDIZ(RIZ)	29	NİSA NUR ÇİFTYILDIZ(RIZ)		33	BÜŞRA BİRLEŞİK(IST)	00 / 11 [03:00]
KARDELEN ŞEVAL KIRÖMEROĞLU(KRS)						
BEYZANUR AKYURT(AKS)	30	BEYZANUR AKYURT(AKS)		39	BÜŞRA BİRLEŞİK(IST)	10 / 00 [00:12]
MARIHA GÜL DEMİR(KCL)						
BURÇİN POLAT(ANK)	31	MARIHA GÜL DEMİR(KCL)	11 / 01 [2:27]	34	ARİFE AYDINOĞLU(DNZ)	00 s1 / 11 [1:40]
KARDELEN BEBEK(KKTC)						
RUMEYSA ALMAZ(VAN)	32	ZELAL DÖLEK(MRD)	10 s1 / 00 [2:04]	40	İLAYDA KURT(IST)	00 s1 / 01 GS [00:11]
		KARDELEN BEBEK(KKTC)		42	İLAYDA KURT(IST)	10 / 00 sH GS [01:20]
		RUMEYSA ALMAZ(VAN)				
		İLAYDA KURT(IST)	00 sH / 11 [2:07]			

3.

3.

52 KG

23 Judoka

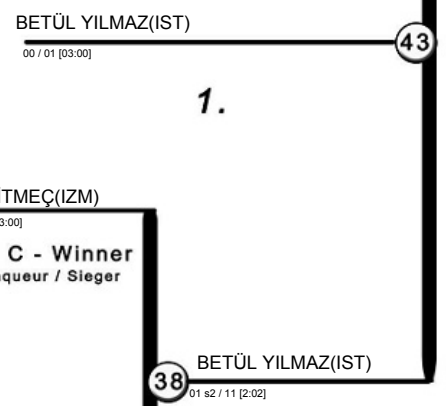
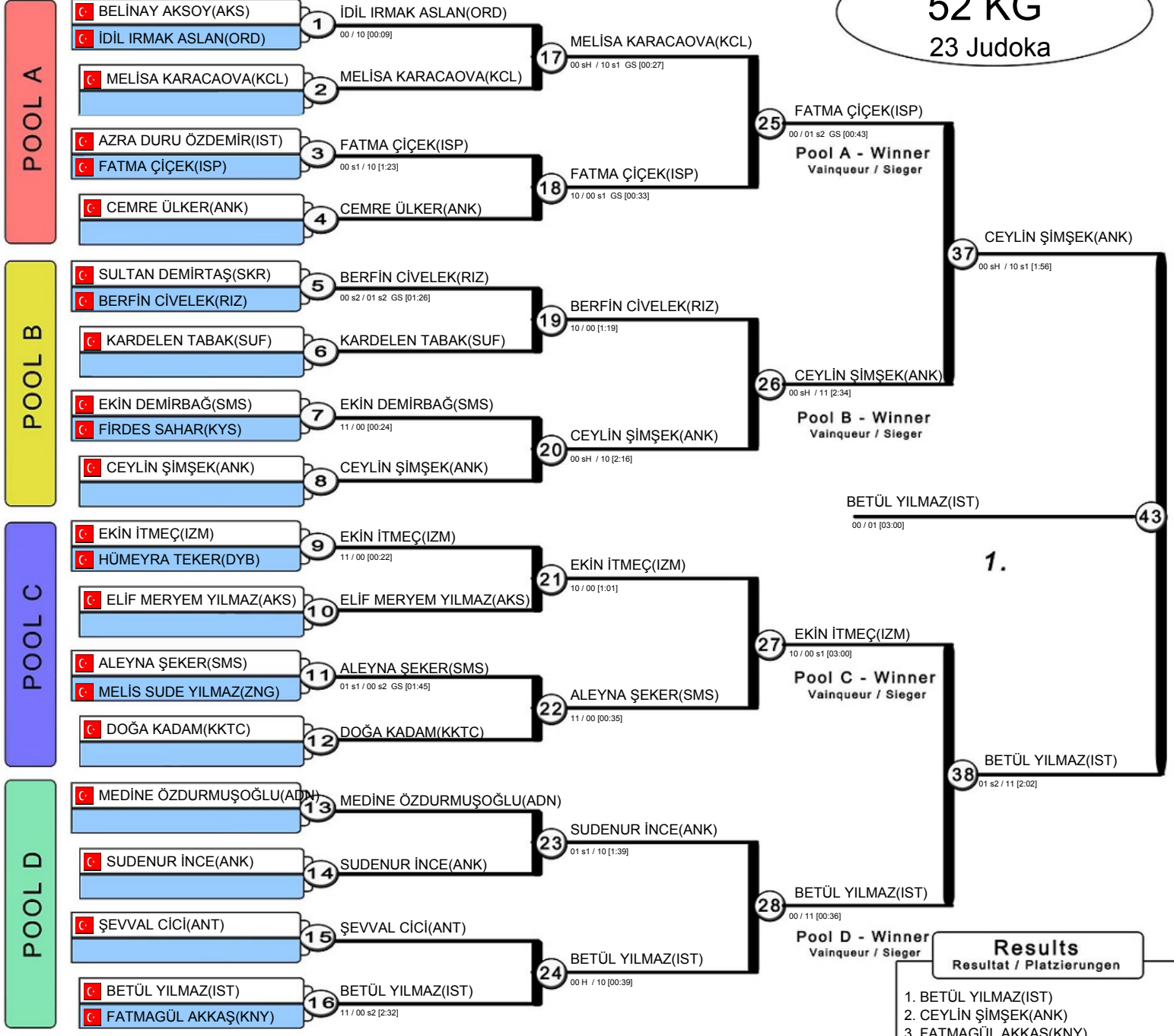

Results
Resultat / Platzierungen

1. BETÜL YILMAZ (IST)
2. CEYLİN ŞİMŞEK (ANK)
3. FATMAGÜL AKKAŞ (KNY)
4. EKİN DEMİRBAĞ (SMS)
5. EKİN İTMEÇ (IZM)
6. FATMA ÇİÇEK (ISP)
7. ALEYNA ŞEKER (SMS)
8. AZRA DURU ÖZDEMİR (IST)



57 KG
23 Judoka

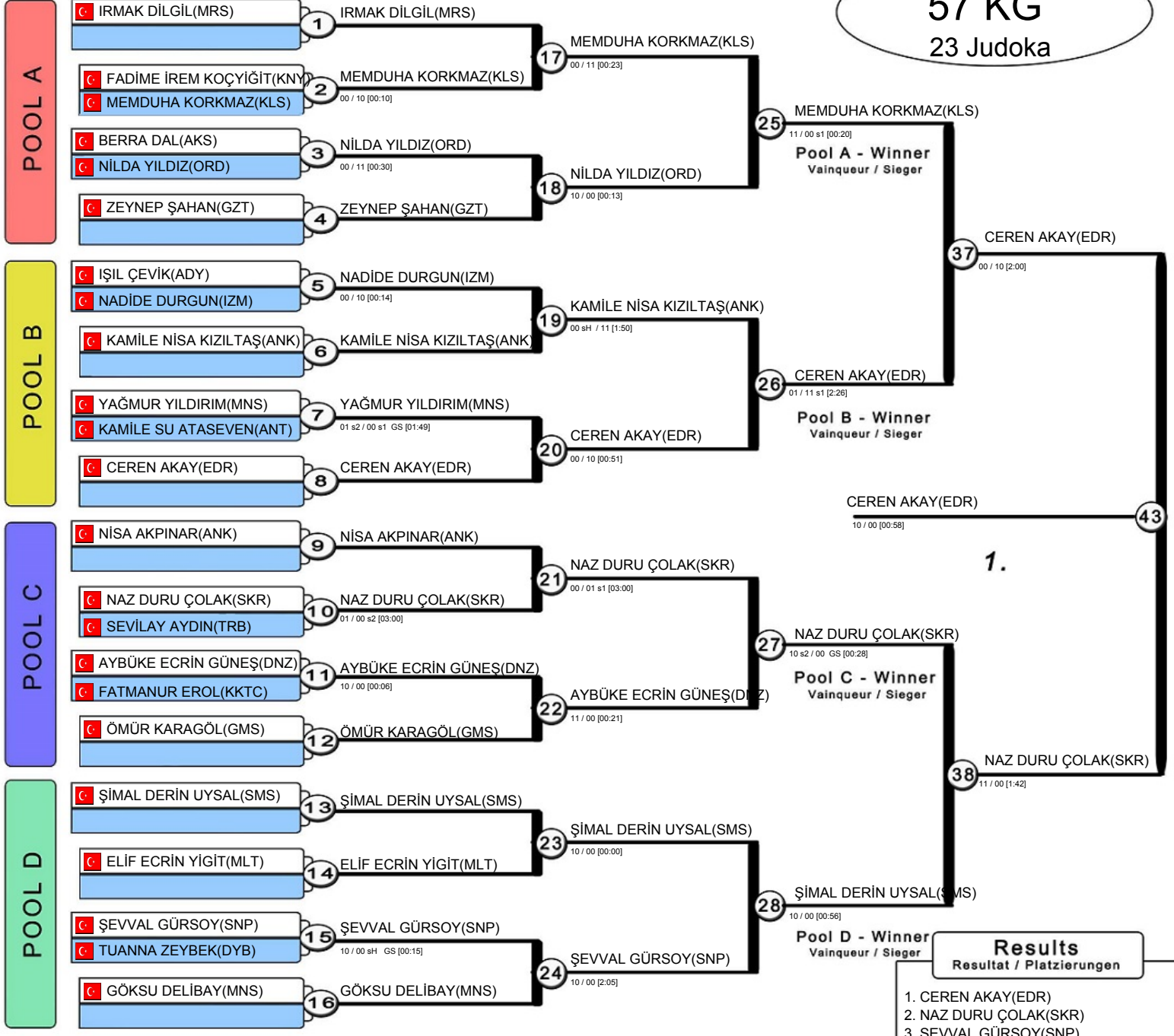

Results
Resultat / Platzierungen

1. CEREN AKAY(EDR)
2. NAZ DURU ÇOLAK(SKR)
3. ŞEVVAL GÜRSOY(SNP)
4. NİLDA YILDIZ(ORD)
5. ŞİMAL DERİN UYSAL(SMS)
6. MEMDUHA KORKMAZ(KLS)
7. KAMİLE NİSA KIZILTAŞ(ANK)
8. AYBÜKE ECRİN GÜNEŞ(DNZ)



63 KG
22 Judoka

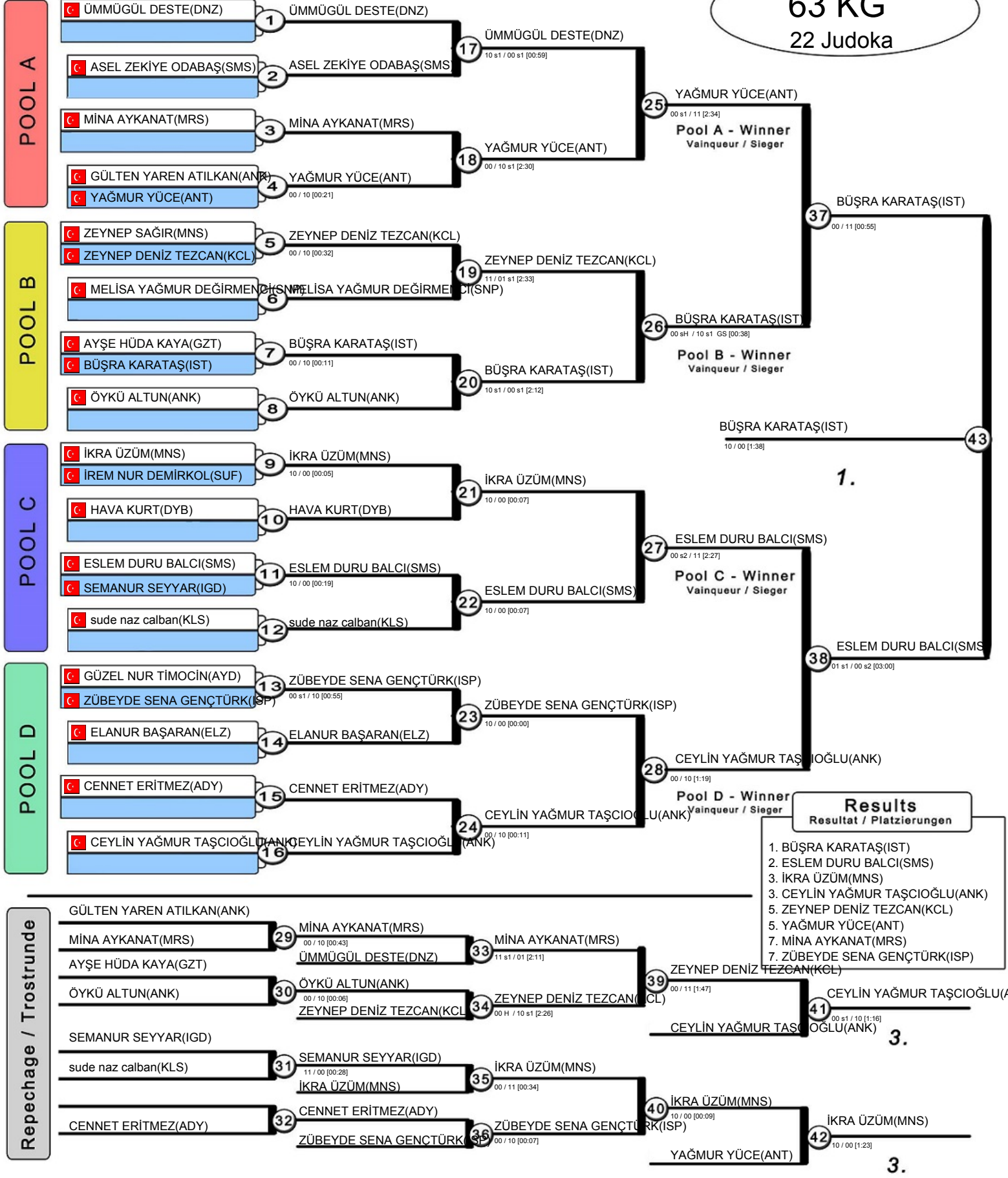

+63 KG
18 Judoka

POOL A

1	SIDIKI NUR ALIÇ(KRM)	SIDIKI NUR ALIÇ(KRM)	17	SIDIKI NUR ALIÇ(KRM)
2	ZEYNEP AYSİMA SAVUR(KCL)	ZEYNEP AYSİMA SAVUR(KCL)	10 / 00 [00:00]	
3	EBRANUR ÖZBEY(RIZ)	EBRANUR ÖZBEY(RIZ)	25	AYÇA KÜÇÜKCESUR(KRB)
4	AYÇA KÜÇÜKCESUR(KRB)	AYÇA KÜÇÜKCESUR(KRB)	00 / 10 [00:29]	18

Pool A - Winner
Vainqueur / Sieger

POOL B

5	ŞUĞRA ŞÜKRIYE ÖZDEMİR(CRM)	ŞUĞRA ŞÜKRIYE ÖZDEMİR(CRM)	10 / 00 [00:52]	19	ŞUĞRA ŞÜKRIYE ÖZDEMİR(CRM)
6	BUSENAZ TÜRKMEN(ANK)	BUSENAZ TÜRKMEN(ANK)	11 / 00 [1:32]		
7	BEYHAN DEMİR(DNZ)	BEYHAN DEMİR(DNZ)	26	HİRA KILKIŞ(MNS)	
8	HİRA KILKIŞ(MNS)	HİRA KILKIŞ(MNS)	00 / 11 [00:33]	20	HİRA KILKIŞ(MNS)

Pool B - Winner
Vainqueur / Sieger

POOL C

9	SUDE NUR BUDAK(ZNG)	SUDE NUR BUDAK(ZNG)	10 s2 / 01 sH [2:52]	21	SUDE NUR BUDAK(ZNG)
10	MERAL SULTAN KAÇAK(ANT)	MERAL SULTAN KAÇAK(ANT)	10 s2 / 00 s2 H [1:57]		
11	NECLA TUANA KARADAĞ(DNZ)	NECLA TUANA KARADAĞ(DNZ)	27	RABİA GÜL AKAN(BRS)	
12	RABİA GÜL AKAN(BRS)	RABİA GÜL AKAN(BRS)	00 s1 / 10 [1:14]	22	RABİA GÜL AKAN(BRS)

Pool C - Winner
Vainqueur / Sieger

POOL D

13	DENİZ EBRAR KILIÇARSLAN(ORD)	DENİZ EBRAR KILIÇARSLAN(ORD)	23	DENİZ EBRAR KILIÇARSLAN(ORD)	
14	CEYDA GÖYNÜK(KKTC)	CEYDA GÖYNÜK(KKTC)	11 / 00 [00:28]		
15	MELİSA KANYAR(IGD)	MELİSA KANYAR(IGD)	28	SULTAN NUR DİKER(MNS)	
16	SULTAN NUR DİKER(MNS)	SULTAN NUR DİKER(MNS)	00 sH / 10 [2:01]	24	SULTAN NUR DİKER(MNS)

Pool D - Winner
Vainqueur / Sieger

HİRA KILKIŞ(MNS)
10 / 00 [00:07]

1.

43

RABİA GÜL AKAN(BRS)
10 / 00 s1 [1:29]

38

Results
Resultat / Platzierungen

1. HİRA KILKIŞ(MNS)
2. RABİA GÜL AKAN(BRS)
3. DENİZ EBRAR KILIÇARSLAN(ORD)
4. SULTAN NUR DİKER(MNS)
5. ŞUĞRA ŞÜKRIYE ÖZDEMİR(CRM)
6. AYÇA KÜÇÜKCESUR(KRB)
7. SIDIKI NUR ALIÇ(KRM)
8. SUDE NUR BUDAK(ZNG)

Repechage / Trostrunde

29	EBRANUR ÖZBEY(RIZ)	33	SIDIKI NUR ALIÇ(KRM)	00 s1 / 11 s1 [1:47]		
30	BEYHAN DEMİR(DNZ)	39	ŞUĞRA ŞÜKRIYE ÖZDEMİR(CRM)	00 s1 / 11 s1 [2:42]	41	SULTAN NUR DİKER(MNS)
31	DAMLA YAĞMUR ÇAKIL(MRD)	35	SUDE NUR BUDAK(ZNG)	00 / 10 [00:53]		
32	MELİSA KANYAR(IGD)	40	DENİZ EBRAR KILIÇARSLAN(ORD)	00 / 11 [00:26]	42	DENİZ EBRAR KILIÇARSLAN(ORD)

3.

3.