



# TÜRKİYE JUDO FEDERASYONU ve OKUL SPORLARI DAİRE BAŞKANLIĞI

OKUL SPORLARI KÜÇÜKLER JUDO TÜRKİYE BİRİNCİLİĞİ

13-14 HAZİRAN 2023 - UŞAK

26 KG

16 Judoka

POOL A

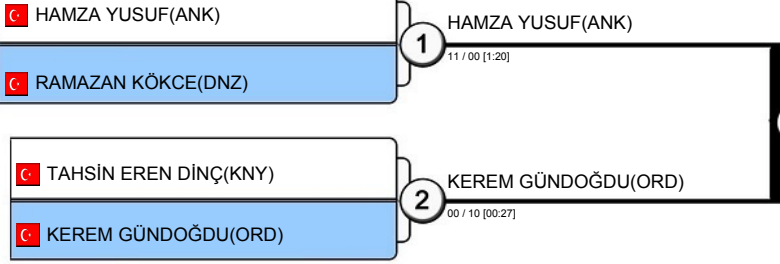

POOL B

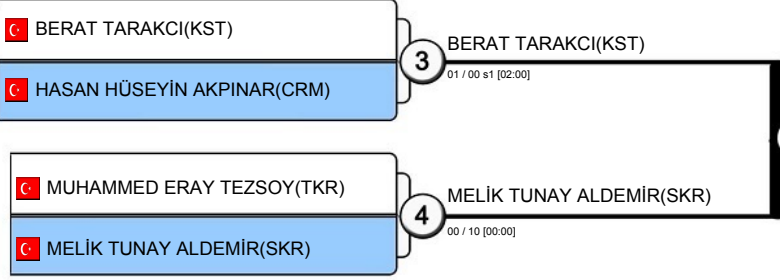

POOL C

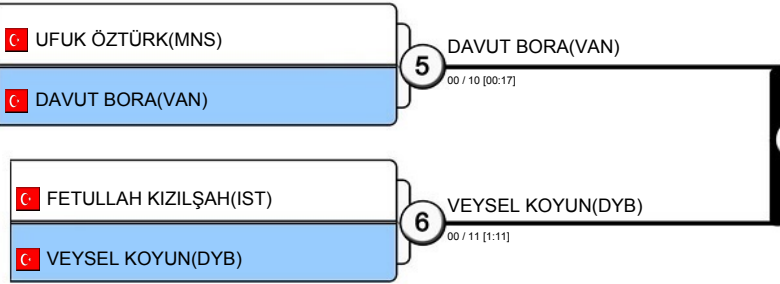

POOL D

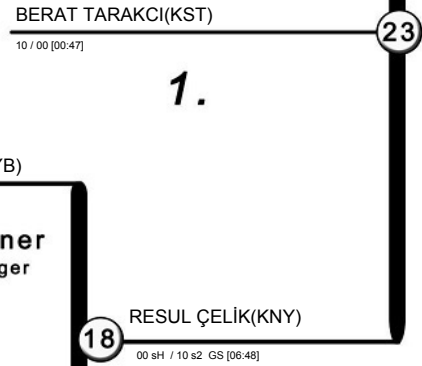
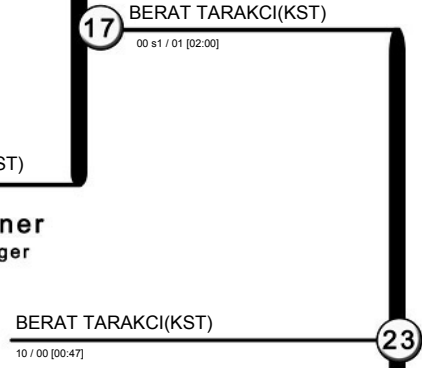
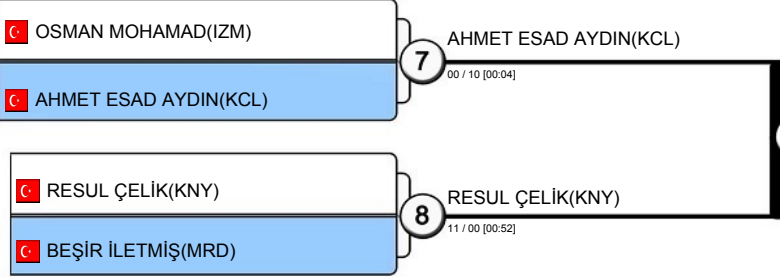

- Results**  
Resultat / Platzierungen
1. BERAT TARAKCI(KST)
  2. RESUL ÇELİK(KNY)
  3. KEREM GÜNDOĞDU(ORD)
  3. MELİK TUNAY ALDEMİR(SKR)
  5. VEysel KOYUN(DYB)
  5. DAVUT BORA(VAN)
  7. HAMZA YUSUF(ANK)
  7. BEŞİR İLETMİŞ(MRD)

Repechage / Trostrunde

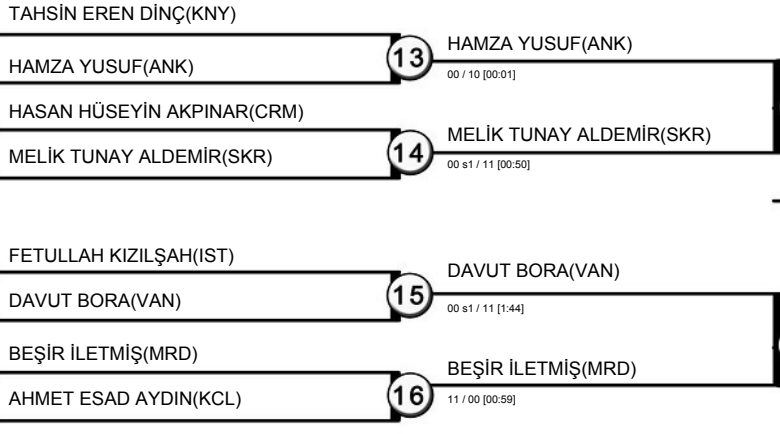

3.

3.

30 KG  
20 Judoka

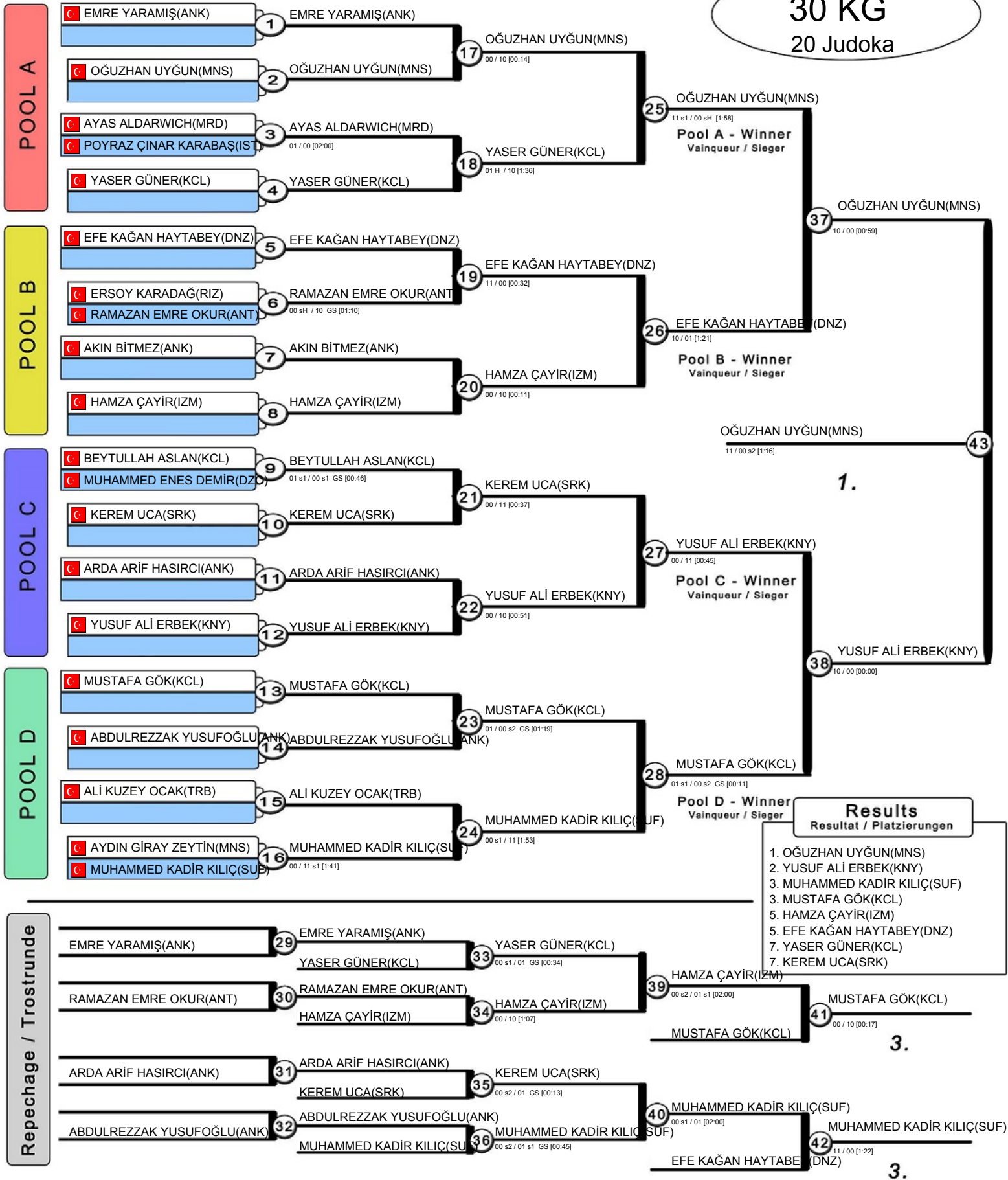

34 KG

22 Judoka

POOL A

UMUT BAYDAR(DYB)	1	UMUT BAYDAR(DYB)	17	YUSUF GÜL(TRB)
YUSUF GÜL(TRB)	2	YUSUF GÜL(TRB)	17	00 / 10 [00:32]
MAHMUD ALYOUSEF(SMS)	3	MAHMUD ALYOUSEF(SMS)	18	SÜLEYMAN DOĞRU(IST)
SÜLEYMAN DOĞRU(IST)	4	SÜLEYMAN DOĞRU(IST)	18	00 / 10 [00:35]
AMMAR KİYAĞ(VAN)	4	AMMAR KİYAĞ(VAN)	10 / 00 [00:00]	

SÜLEYMAN DOĞRU(IST)  
Pool A - Winner  
Vainqueur / Sieger

POOL B

VEYSEL AĞAR(BTM)	5	RECEP YİĞİT TÜRKMEN(KNY)	19	RECEP YİĞİT TÜRKMEN(KNY)
RECEP YİĞİT TÜRKMEN(KNY)	5	RECEP YİĞİT TÜRKMEN(KNY)	19	00 s1 / 11 [00:26]
MUSTAFA BAL(DNZ)	6	MUSTAFA BAL(DNZ)	20	HASAN ALP ÇAVDAR(KCL)
HAMZA ÇİNKAYA(ANK)	7	HAMZA ÇİNKAYA(ANK)	20	10 / 00 [1:10]
AZİZ KERİM ERTEM(MNS)	7	AZİZ KERİM ERTEM(MNS)	10 / 00 s1 [1:57]	
HASAN ALP ÇAVDAR(KCL)	8	HASAN ALP ÇAVDAR(KCL)	20	00 / 01 [02:00]

RECEP YİĞİT TÜRKMEN(KNY)  
Pool B - Winner  
Vainqueur / Sieger

POOL C

HÜSEYİN TALHA ÖZDEMİR(DNZ)	9	HÜSEYİN TALHA ÖZDEMİR(DNZ)	21	TUFAN KURT(IST)
UMUT CAN KANDEMİR(ANT)	9	UMUT CAN KANDEMİR(ANT)	10 / 01 [00:48]	
TUFAN KURT(IST)	10	TUFAN KURT(IST)	22	AYAZ ALAYILDIZ(DZC)
HAMZA ÖZBEK(ANK)	11	EGE BALCI(EDR)	22	01 / 11 s1 GS [00:26]
EGE BALCI(EDR)	11	EGE BALCI(EDR)	00 s2 / 01 [02:00]	
AYAZ ALAYILDIZ(DZC)	12	AYAZ ALAYILDIZ(DZC)	22	00 s2 H / 10 s2 GS [02:10]

TUFAN KURT(IST)  
Pool C - Winner  
Vainqueur / Sieger

POOL D

SAMED DURMUŞ(ANK)	13	SAMED DURMUŞ(ANK)	23	MUHAMMET BARKAN YILDIZ(BRS)
MUHAMMET BARKAN YILDIZ(BRS)	13	MUHAMMET BARKAN YILDIZ(BRS)	23	00 / 10 [00:07]
CUMALİ LOĞDURCU(SUF)	15	CUMALİ LOĞDURCU(SUF)	24	EMİR GÖK(KCL)
UMUT KABAK(CRM)	15	UMUT KABAK(CRM)	10 s2 / 00 sH GS [01:54]	
EMİR GÖK(KCL)	16	EMİR GÖK(KCL)	24	00 / 01 s1 [02:00]

MUHAMMET BARKAN YILDIZ(BRS)  
Pool D - Winner  
Vainqueur / Sieger

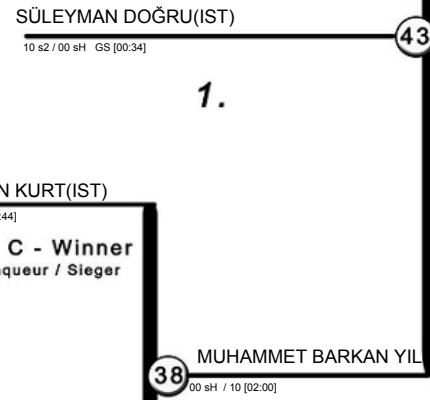

Results  
Resultat / Platzierungen

- SÜLEYMAN DOĞRU(IST)
- MUHAMMET BARKAN YILDIZ(BRS)
- EMİR GÖK(KCL)
- TUFAN KURT(IST)
- YUSUF GÜL(TRB)
- RECEP YİĞİT TÜRKMEN(KNY)
- AYAZ ALAYILDIZ(DZC)
- VEYSEL AĞAR(BTM)

Repechage / Trostrunde

AMMAR KİYAĞ(VAN)	29	MAHMUD ALYOUSEF(SMS)	33	YUSUF GÜL(TRB)
MAHMUD ALYOUSEF(SMS)	29	MAHMUD ALYOUSEF(SMS)	00 / 10 [00:00]	
VEYSEL AĞAR(BTM)	30	VEYSEL AĞAR(BTM)	34	VEYSEL AĞAR(BTM)
MUSTAFA BAL(DNZ)	30	MUSTAFA BAL(DNZ)	11 / 00 [1:39]	
HÜSEYİN TALHA ÖZDEMİR(DNZ)	31	HÜSEYİN TALHA ÖZDEMİR(DNZ)	35	AYAZ ALAYILDIZ(DZC)
SAMED DURMUŞ(ANK)	32	SAMED DURMUŞ(ANK)	36	EMİR GÖK(KCL)
EMİR GÖK(KCL)	32	EMİR GÖK(KCL)	00 s1 / 10 [1:30]	
YUSUF GÜL(TRB)	39	YUSUF GÜL(TRB)	41	TUFAN KURT(IST)
YUSUF GÜL(TRB)	39	YUSUF GÜL(TRB)	11 / 00 [1:09]	
EMİR GÖK(KCL)	40	EMİR GÖK(KCL)	42	RECEP YİĞİT TÜRKMEN(KNY)
EMİR GÖK(KCL)	40	EMİR GÖK(KCL)	00 / 01 s1 [02:00]	
RECEP YİĞİT TÜRKMEN(KNY)	42	RECEP YİĞİT TÜRKMEN(KNY)	11 / 00 [00:49]	

3.

3.

38 KG

22 Judoka

POOL A

MUSTAFA CAN ÖZÇELİK(SMS)	1	MUSTAFA CAN ÖZÇELİK(SMS)	17
MUHAMMET HAMZA AKTAŞ(ANK)	2	MUHAMMET HAMZA AKTAŞ(ANK)	17
MUHAMMED BERAT ŞAHİN(GRS)	3	ALİ TAHA İNCİ(MNS)	25
ALİ TAHA İNCİ(MNS)	3	ALİ TAHA İNCİ(MNS)	18
FURKAN DOĞAN(KCL)	4	FURKAN DOĞAN(KCL)	18

ALİ TAHA İNCİ(MNS)  
00 / 10 s1 [1:41]  
**Pool A - Winner**  
Vainqueur / Sieger

POOL B

UTKU SERT(KCL)	5	ŞAHİN ÖZÇELİK(MRD)	19
ŞAHİN ÖZÇELİK(MRD)	5	ŞAHİN ÖZÇELİK(MRD)	19
ERDİNÇ ÖZER(IST)	6	ERDİNÇ ÖZER(IST)	19
MUKHAMMED KADYROV(ANT)	7	MUKHAMMED KADYROV(ANT)	20
MEHMET EMİR ULUSOY(KNY)	8	OĞUZHAN KULAKSIZ(SVS)	20
OĞUZHAN KULAKSIZ(SVS)	8	OĞUZHAN KULAKSIZ(SVS)	20

OĞUZHAN KULAKSIZ(SVS)  
00 / 01 s1 [02:00]  
**Pool B - Winner**  
Vainqueur / Sieger

POOL C

KEREM ÇEBİ(IST)	9	KEREM ÇEBİ(IST)	21
MÜCAHİT KEREM KARAKEÇİLİ(SUF)	10	KEREM ÇEBİ(IST)	21
MOKHMAD SALAKH SIRIOĞLU(KCL)	10	MOKHMAD SALAKH SIRIOĞLU(KCL)	21
ARAS MEHMET DEMİRÖZ(ANT)	11	ARAS MEHMET DEMİRÖZ(ANT)	22
EMRE BALCI(AMS)	11	KADİR MERT TEMÜR(KNY)	22
KADİR MERT TEMÜR(KNY)	12	KADİR MERT TEMÜR(KNY)	22

KEREM ÇEBİ(IST)  
01 / 00 s1 GS [00:39]  
**Pool C - Winner**  
Vainqueur / Sieger

POOL D

MARJ SHAHANKARY(SMS)	13	MARJ SHAHANKARY(SMS)	23
MEHMET EMİN İLHAN(DYB)	13	MARJ SHAHANKARY(SMS)	23
HALİL İBRAHİM SARIASLAN(ANK)	14	HALİL İBRAHİM SARIASLAN(ANK)	24
SAMET BULUK(IST)	15	SAMET BULUK(IST)	28
HIZIR REİS BAŞ(KCL)	16	HIZIR REİS BAŞ(KCL)	24
SAMET BULUK(IST)	15	SAMET BULUK(IST)	24

SAMET BULUK(IST)  
00 s1 / 01 s1 GS [00:46]  
**Pool D - Winner**  
Vainqueur / Sieger

SAMET BULUK(IST)  
00 / 01 s1 GS [00:46]

1.

SAMET BULUK(IST)  
00 sH / 10 s1 GS [02:44]

**Results**  
Resultat / Platzierungen

1. SAMET BULUK(IST)
2. OĞUZHAN KULAKSIZ(SVS)
3. MARJ SHAHANKARY(SMS)
4. KEREM ÇEBİ(IST)
5. ŞAHİN ÖZÇELİK(MRD)
6. ALİ TAHA İNCİ(MNS)
7. KADİR MERT TEMÜR(KNY)
8. MUSTAFA CAN ÖZÇELİK(SMS)

Repechage / Trostrunde

MUHAMMED BERAT ŞAHİN(GRS)	29	MUHAMMED BERAT ŞAHİN(GRS)	33
FURKAN DOĞAN(KCL)	29	MUSTAFA CAN ÖZÇELİK(SMS)	33
MEHMET EMİR ULUSOY(KNY)	30	MUSTAFA CAN ÖZÇELİK(SMS)	33
MUKHAMMED KADYROV(ANT)	30	MEHMET EMİR ULUSOY(KNY)	39
MÜCAHİT KEREM KARAKEÇİLİ(SUF)	31	ŞAHİN ÖZÇELİK(MRD)	39
MOKHMAD SALAKH SIRIOĞLU(KCL)	31	ŞAHİN ÖZÇELİK(MRD)	39
HIZIR REİS BAŞ(KCL)	32	KADİR MERT TEMÜR(KNY)	41
MARJ SHAHANKARY(SMS)	36	KADİR MERT TEMÜR(KNY)	41
MARJ SHAHANKARY(SMS)	36	KEREM ÇEBİ(IST)	41
MARJ SHAHANKARY(SMS)	36	KEREM ÇEBİ(IST)	41
MARJ SHAHANKARY(SMS)	36	MARJ SHAHANKARY(SMS)	40
MARJ SHAHANKARY(SMS)	36	MARJ SHAHANKARY(SMS)	42
MARJ SHAHANKARY(SMS)	36	ALİ TAHA İNCİ(MNS)	42

3.

3.



46 KG

19 Judoka

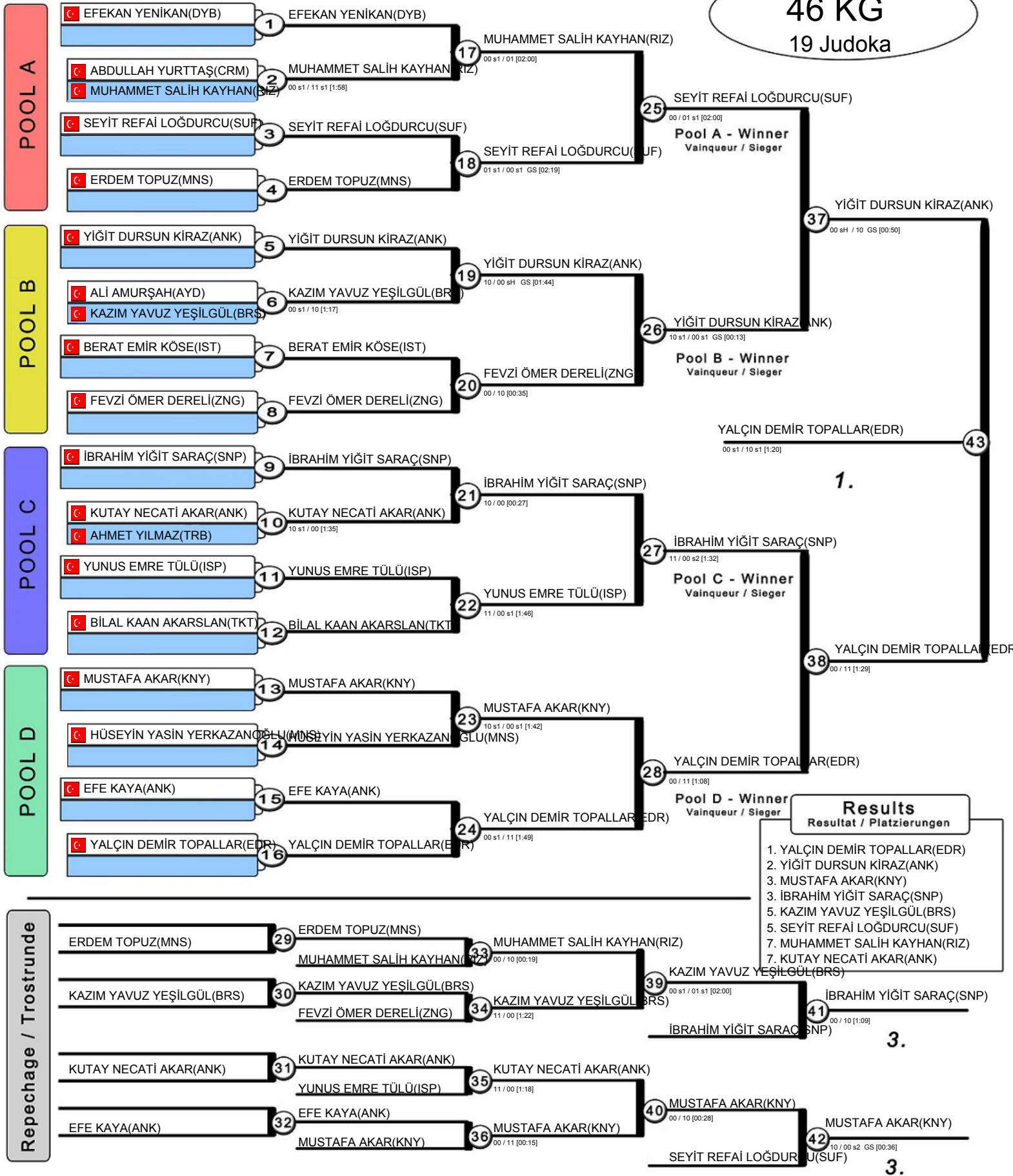

50 KG

18 Judoka

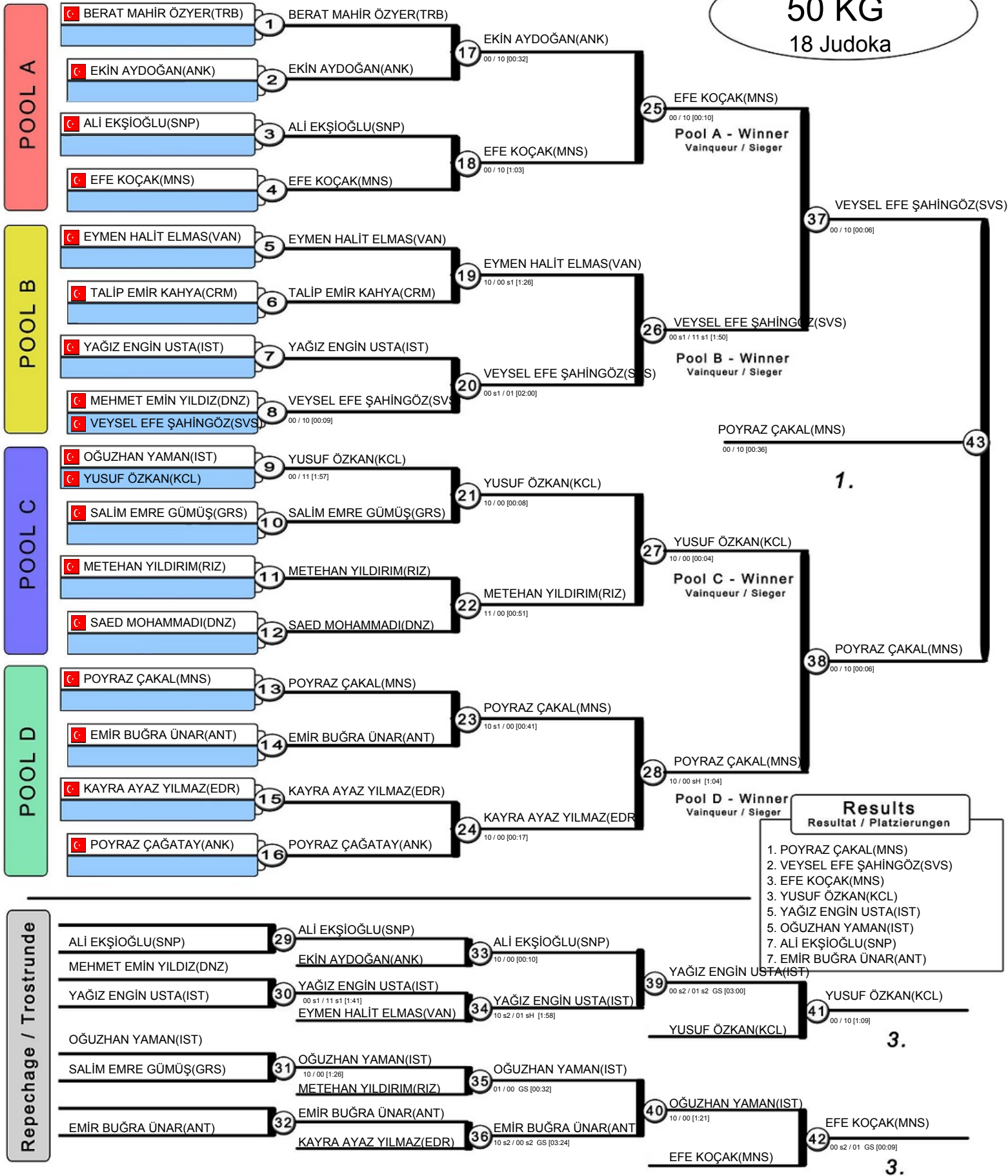

55 KG

18 Judoka

POOL A

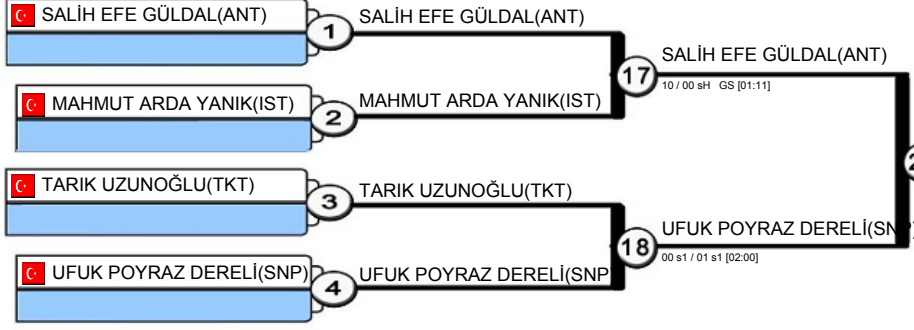

POOL B

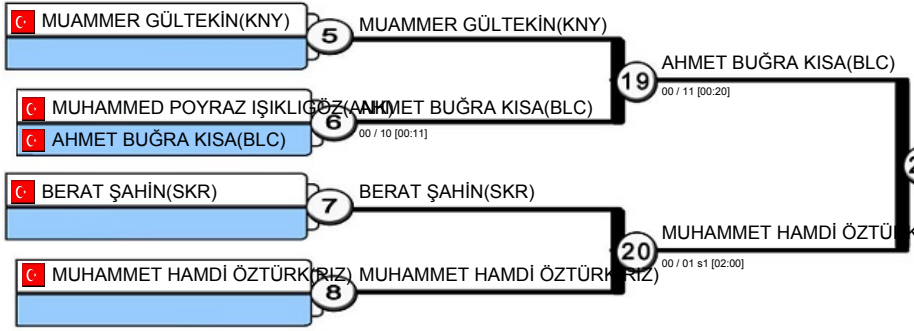

POOL C

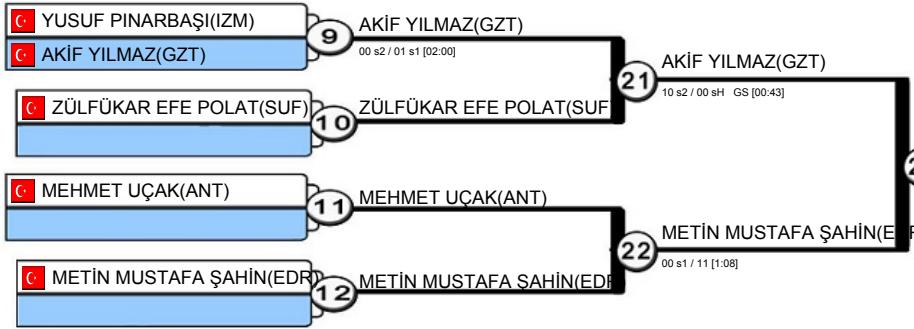

POOL D

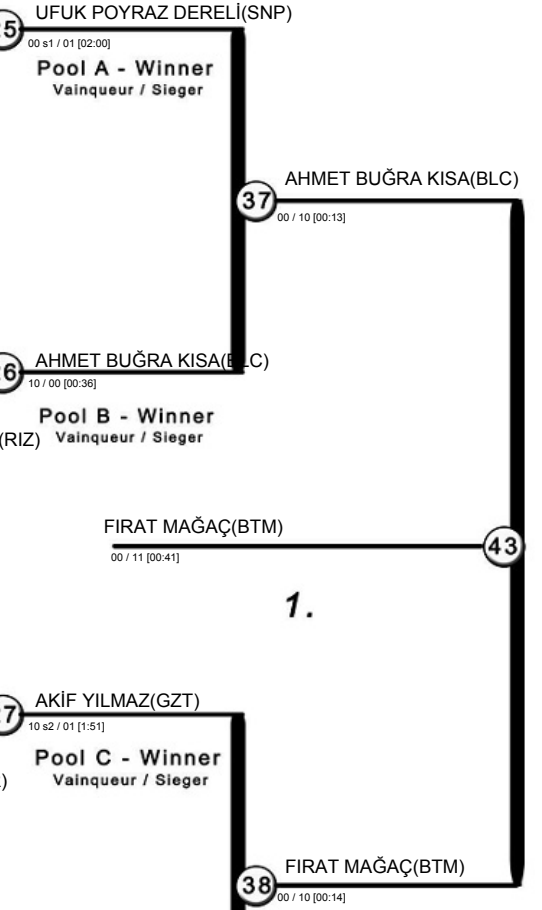
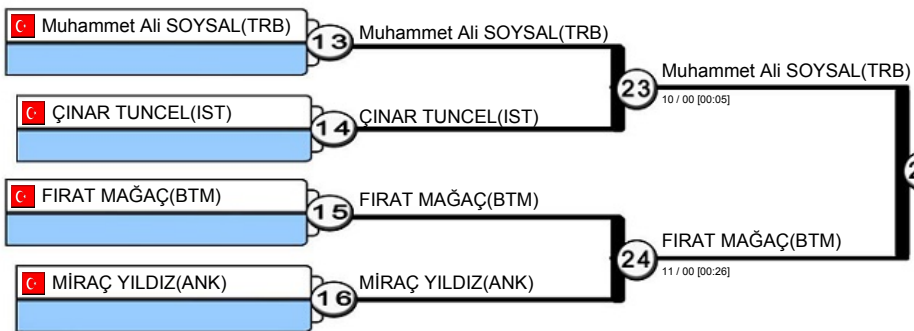

1.

38

Results  
Resultat / Platzierungen

1. FIRAT MAĞAÇ(BTM)
2. AHMET BUĞRA KISA(BLC)
3. METİN MUSTAFA ŞAHİN(EDR)
5. AKİF YILMAZ(GZT)
5. UFUK POYRAZ DERELİ(SNP)
7. SALİH EFE GÜLDAL(ANT)
7. Muhammet Ali SOYSAL(TRB)

Repechage / Trostrunde

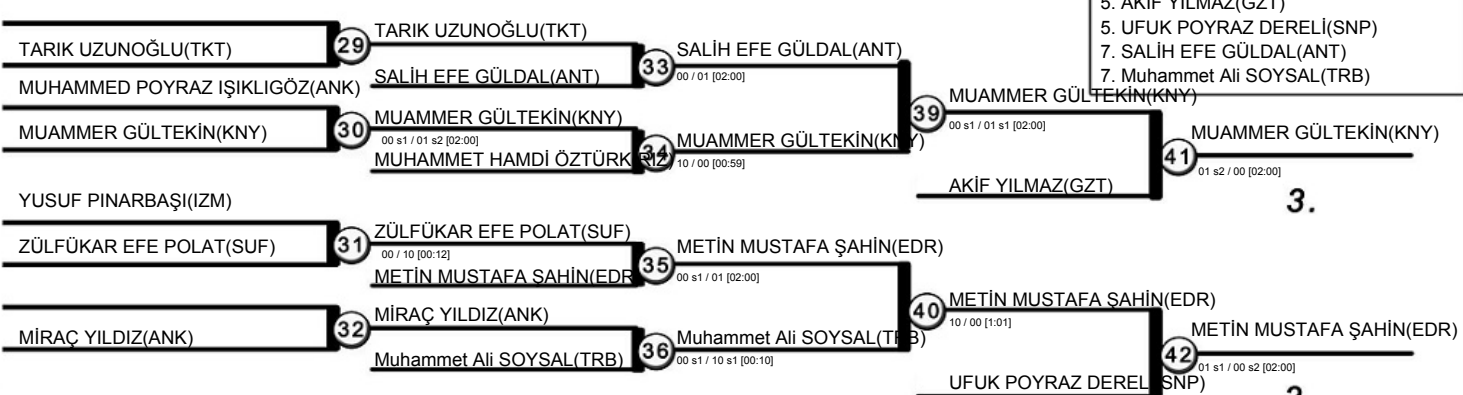

3.

3.



60 KG

15 Judoka

POOL A

1 MUHAMMET EMİN DALKILIÇ(DZC)

2 MİKAİL GÜRBÜZ(BTM)

10 / 00 [00:10]

2 SAMED MALİK KEÇELİOĞLU(DNZ)

10 / 00 [00:00]

17 MUHAMMET EMİN DALKILIÇ(DZC)

3 HAKTAN SEMİH AYDOĞAN(CRM)

00 / 10 s1 [00:59]

4 ALPEREN BEKTAŞ(AJD)

00 / 10 [00:00]

10 ALPEREN BEKTAŞ(AJD)

00 s1 / 10 [00:42]

17 MUHAMMET EMİN DALKILIÇ(DZC)

5 NİHAT EGE BAYDEMİR(ESK)

00 / 10 [00:06]

6 GÖRKEM KIR(ANK)

10 / 00 [00:00]

11 GÖRKEM KIR(ANK)

01 / 10 [00:42]

18 KAĞAN KUZEY UZUN(ZNG)

00 s2 / 10 s2 GS [00:14]

7 KAĞAN KUZEY UZUN(ZNG)

01 s2 / 00 s2 GS [00:12]

8 ORÇUN GÜNEY(IST)

00 sH / 10 s2 GS [00:40]

12 KAĞAN KUZEY UZUN(ZNG)

01 s2 / 00 s2 GS [00:12]

21 MİKAİL GÜRBÜZ(BTM)

10 / 00 [00:17]

22 ALPEREN BEKTAŞ(AJD)

00 s1 / 10 [1:32]

13 MİKAİL GÜRBÜZ(BTM)

11 / 00 [00:43]

14 HAKTAN SEMİH AYDOĞAN(CRM)

00 / 10 [00:00]

15 NİHAT EGE BAYDEMİR(ESK)

00 / 10 [00:00]

16 ORÇUN GÜNEY(IST)

01 s2 / 00 [02:00]

19 MİKAİL GÜRBÜZ(BTM)

10 / 00 [00:17]

20 NİHAT EGE BAYDEMİR(ESK)

01 s2 / 00 [02:00]

21 MİKAİL GÜRBÜZ(BTM)

11 s2 / 01 s1 [1:45]

22 ALPEREN BEKTAŞ(AJD)

00 s1 / 10 [1:32]

MUHAMMET EMİN DALKILIÇ(DZC)

Pool A - Winner  
Vainqueur / Sieger

Pool B - Winner  
Vainqueur / Sieger

Pool C - Winner  
Vainqueur / Sieger

Pool D - Winner  
Vainqueur / Sieger

KAĞAN KUZEY UZUN(ZNG)  
00 / 11 s1 [1:35]

1.

KAĞAN KUZEY UZUN(ZNG)

00 s2 / 10 s2 GS [00:14]

Results

Resultat / Platzierungen

- KAĞAN KUZEY UZUN(ZNG)
- MUHAMMET EMİN DALKILIÇ(DZC)
- ALPEREN BEKTAŞ(AJD)
- MİKAİL GÜRBÜZ(BTM)
- GÖRKEM KIR(ANK)
- NİHAT EGE BAYDEMİR(ESK)
- ORÇUN GÜNEY(IST)
- HAKTAN SEMİH AYDOĞAN(CRM)

Repechage / Trostrunde

MİKAİL GÜRBÜZ(BTM)

SAMED MALİK KEÇELİOĞLU(DNZ)

MUHAMMED EMİR OĞUZ(ANK)

HAKTAN SEMİH AYDOĞAN(CRM)

FATİH YILMAZ(ANT)

NİHAT EGE BAYDEMİR(ESK)

ORÇUN GÜNEY(IST)

13 MİKAİL GÜRBÜZ(BTM)

11 / 00 [00:43]

14 HAKTAN SEMİH AYDOĞAN(CRM)

00 / 10 [00:00]

15 NİHAT EGE BAYDEMİR(ESK)

00 / 10 [00:00]

16 ORÇUN GÜNEY(IST)

01 s2 / 00 [02:00]

19 MİKAİL GÜRBÜZ(BTM)

10 / 00 [00:17]

GÖRKEM KIR(ANK)

20 NİHAT EGE BAYDEMİR(ESK)

01 s2 / 00 [02:00]

22 ALPEREN BEKTAŞ(AJD)

00 s1 / 10 [1:32]

3.

3.

**+60 KG**  
18 Judoka

POOL A

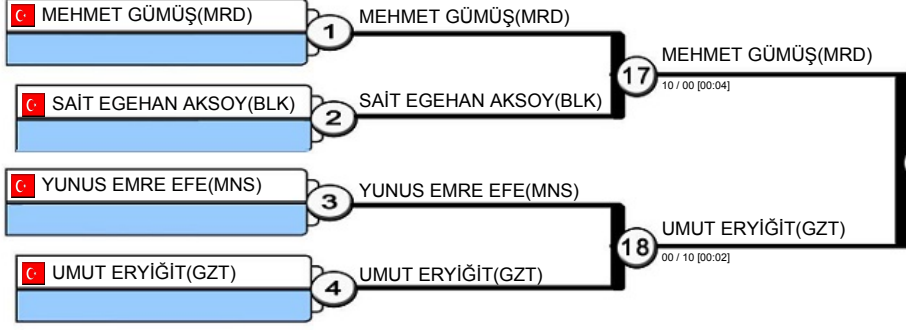

**Pool A - Winner**  
Vainqueur / Sieger

POOL B

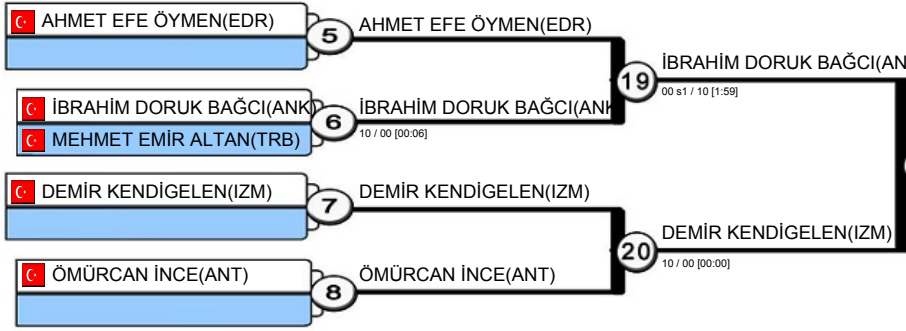

**Pool B - Winner**  
Vainqueur / Sieger

POOL C

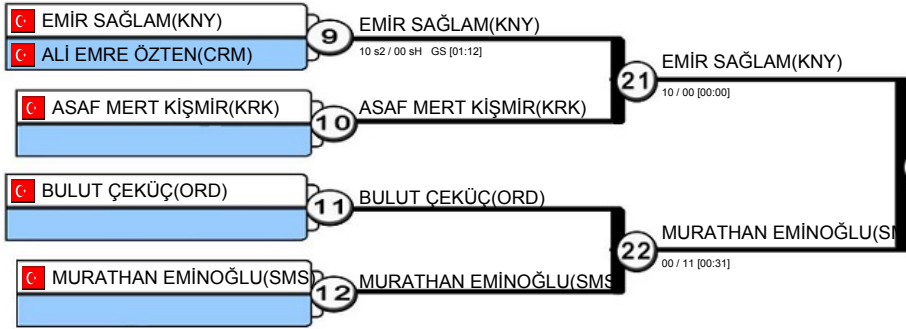

**Pool C - Winner**  
Vainqueur / Sieger

POOL D

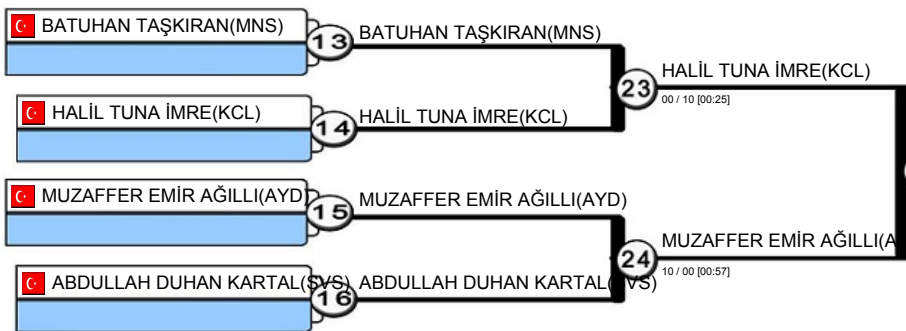

**Pool D - Winner**  
Vainqueur / Sieger

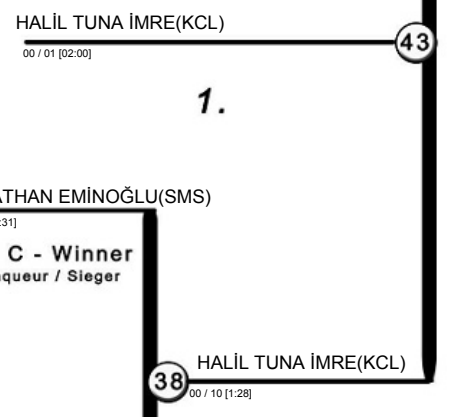

1.

**Results**  
Resultat / Platzierungen

1. HALİL TUNA İMRE(KCL)
2. İBRAHİM DORUK BAĞCI(ANK)
3. UMUT ERYİĞİT(GZT)
3. MURATHAN EMİNOĞLU(SMS)
5. AHMET EFE ÖYMEN(EDR)
5. EMİR SAĞLAM(KNY)
7. YUNUS EMRE EFE(MNS)
7. BATUHAN TAŞKIRAN(MNS)

3.

3.

Repechage / Trostrunde

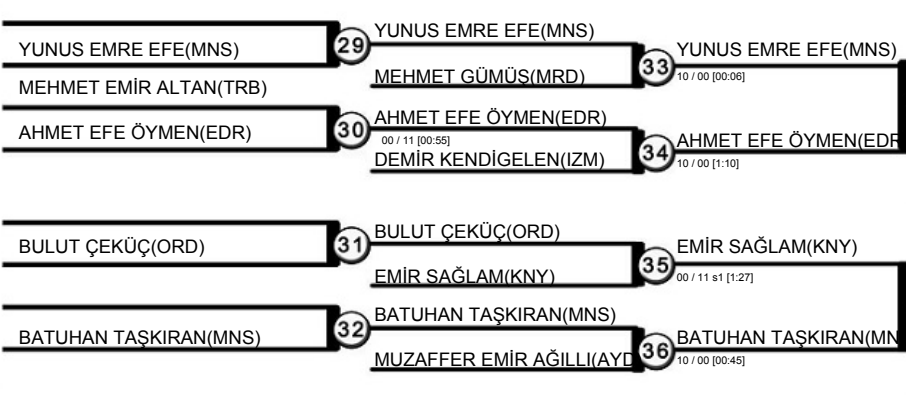



28 KG

20 Judoka

POOL A

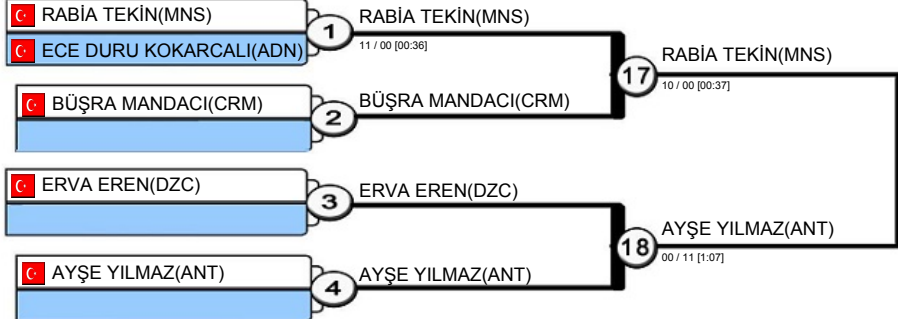

POOL B

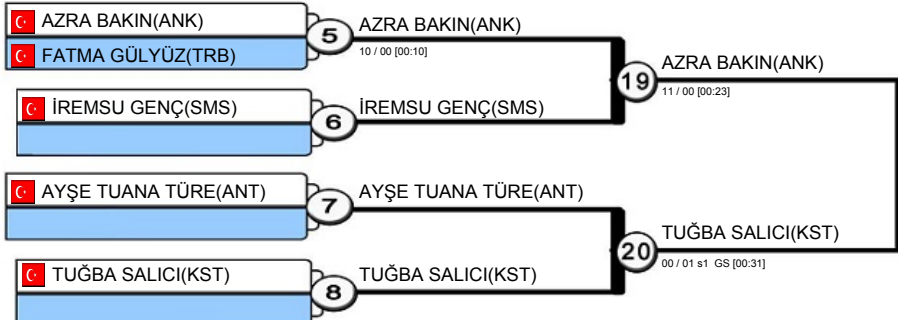

POOL C

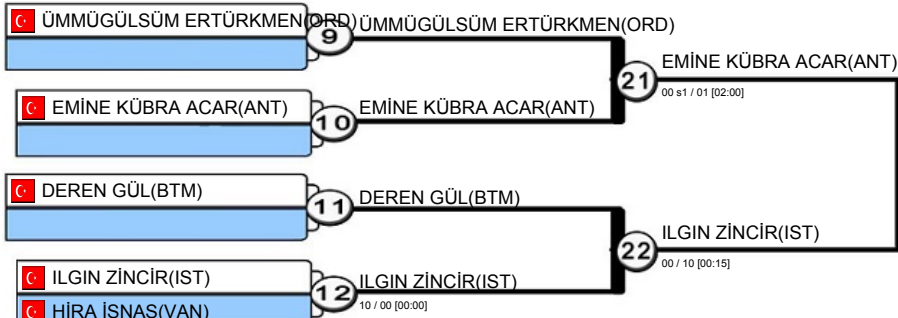

POOL D

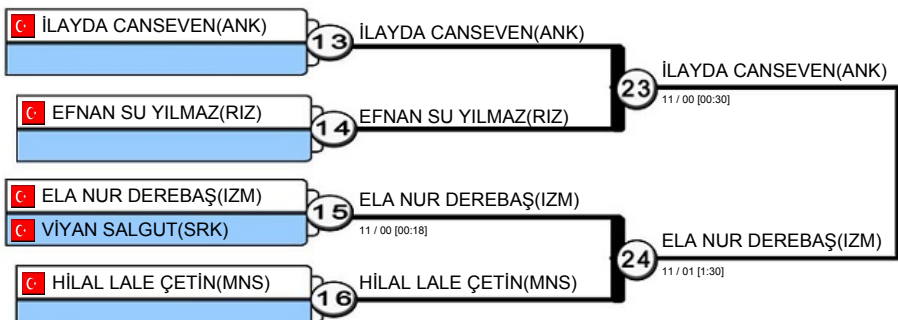

Repechage / Trostrunde

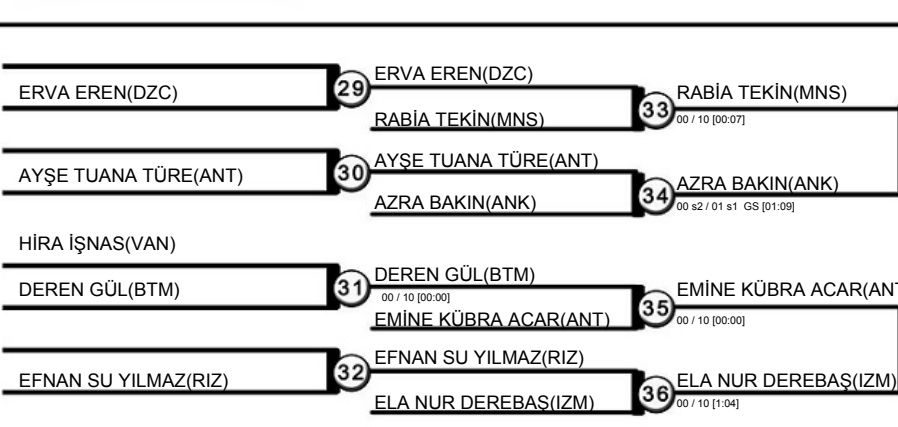

**Results**  
Resultat / Platzierungen

- TUĞBA SALICI(KST)
- İLAYDA CANSEVEN(ANK)
- AYŞE YILMAZ(ANT)
- İLGIN ZİNCİR(IST)
- AZRA BAKIN(ANK)
- EMİNE KÜBRA ACAR(ANT)
- RABİA TEKİN(MNS)
- ELA NUR DEREBAŞ(IZM)

32 KG

21 Judoka

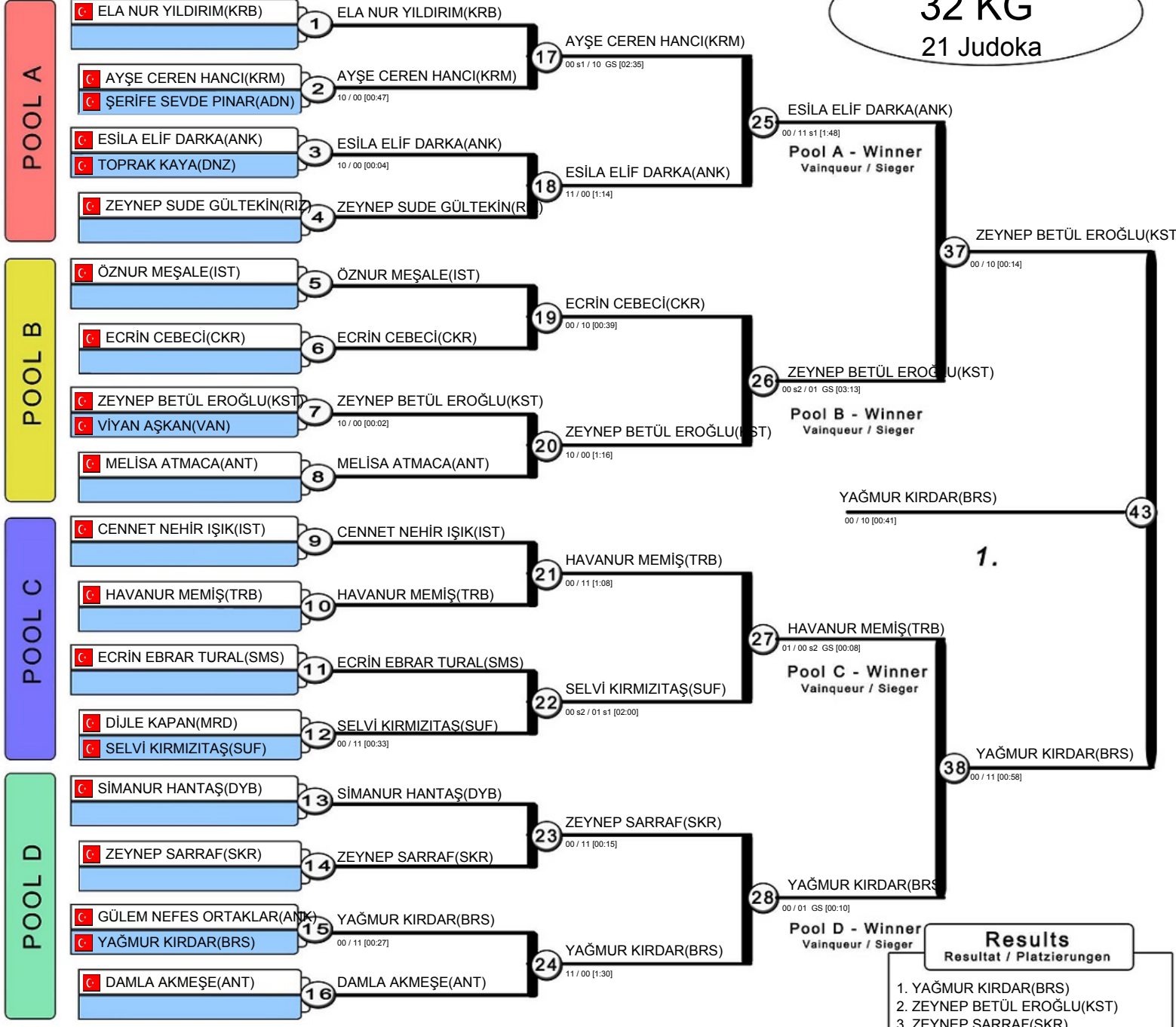

**Results**  
Resultat / Platzierungen

1. YAĞMUR KIRDAR(BRS)
2. ZEYNEP BETÜL EROĞLU(KST)
3. ZEYNEP SARRAF(SKR)
3. AYŞE CEREN HANCI(KRM)
5. HAVANUR MEMİŞ(TRB)
5. ESİLA ELİF DARKA(ANK)
7. CENNET NEHİR İŞİK(IST)
7. ECRİN CEBECİ(CKR)

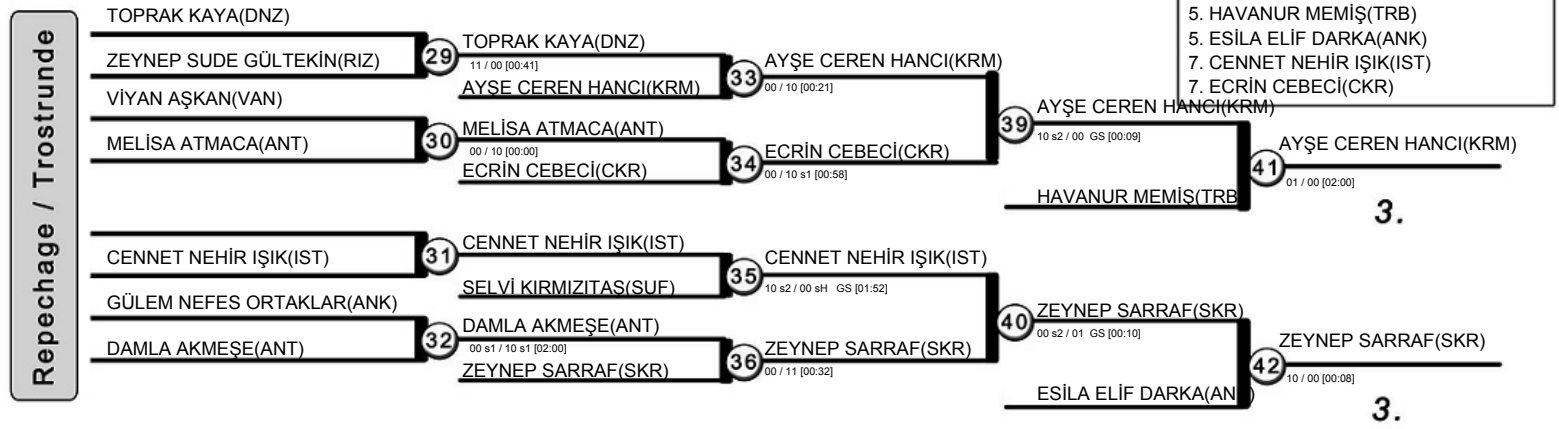

36 KG

20 Judoka

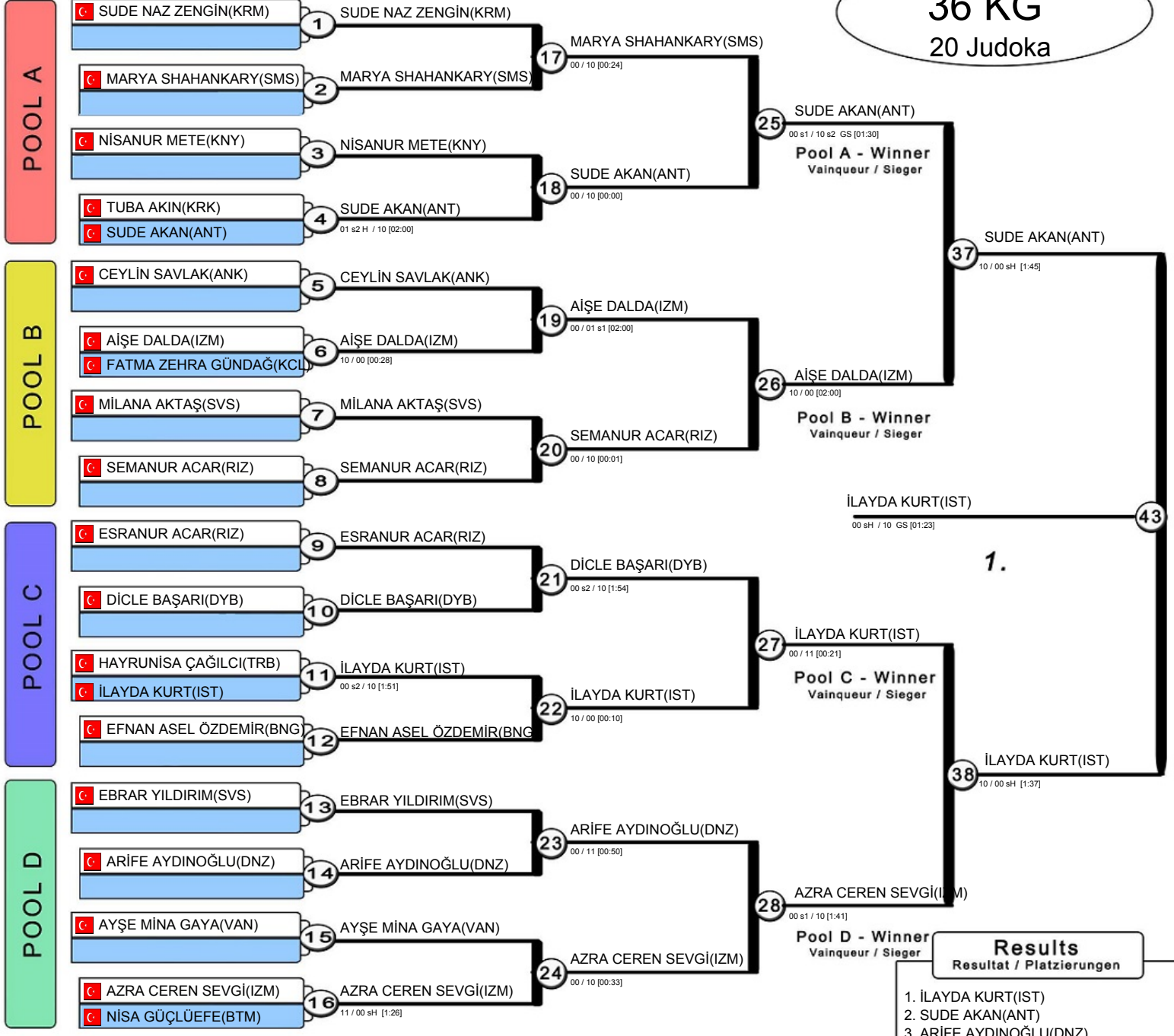

**Results**  
Resultat / Platzierungen

1. İLAYDA KURT(IST)
2. SUDE AKAN(ANT)
3. ARİFE AYDINOĞLU(DNZ)
3. AZRA CEREN SEVGİ(IZM)
5. MARYA SHAHANKARY(SMS)
5. AİŞE DALDA(IZM)
7. SEMANUR ACAR(RIZ)
7. DİCLE BAŞARI(DYB)

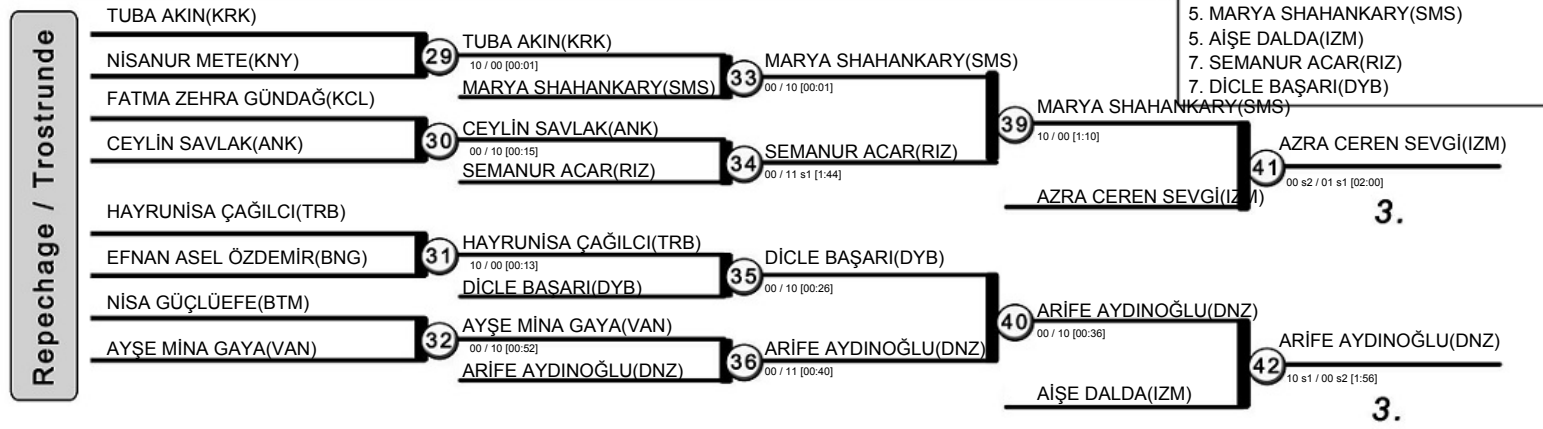

40 KG  
21 Judoka

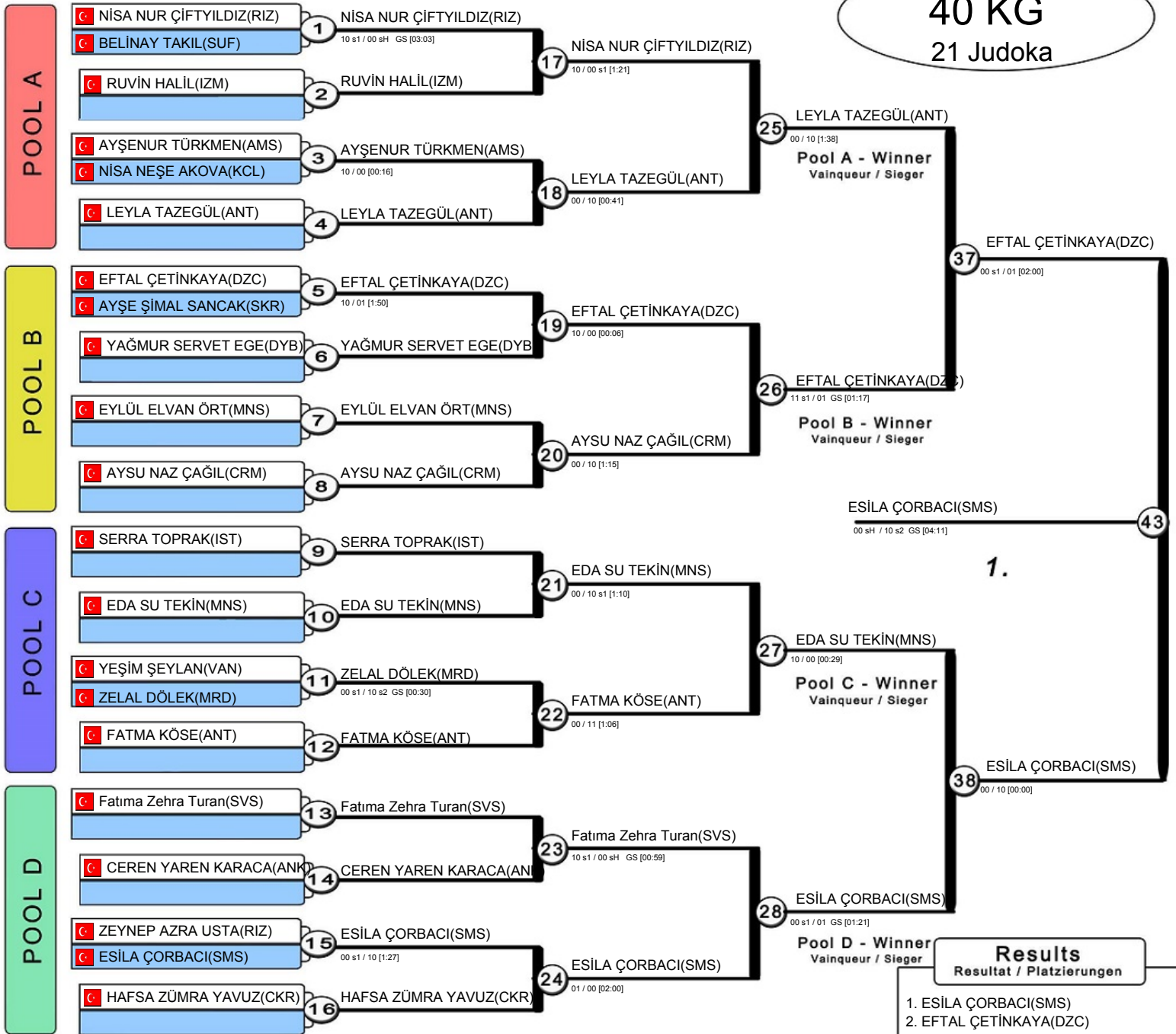

- Results**  
Resultat / Platzierungen
1. ESİLA ÇORBACI(SMS)
  2. EFTAL ÇETİNKAYA(DZC)
  3. Fatma Zehra Turan(SVS)
  4. AYŞENUR TÜRKMEN(AMS)
  5. EDA SU TEKİN(MNS)
  6. LEYLA TAZEGÜL(ANT)
  7. FATMA KÖSE(ANT)
  8. AYSU NAZ ÇAĞIL(CRM)



44 KG

18 Judoka

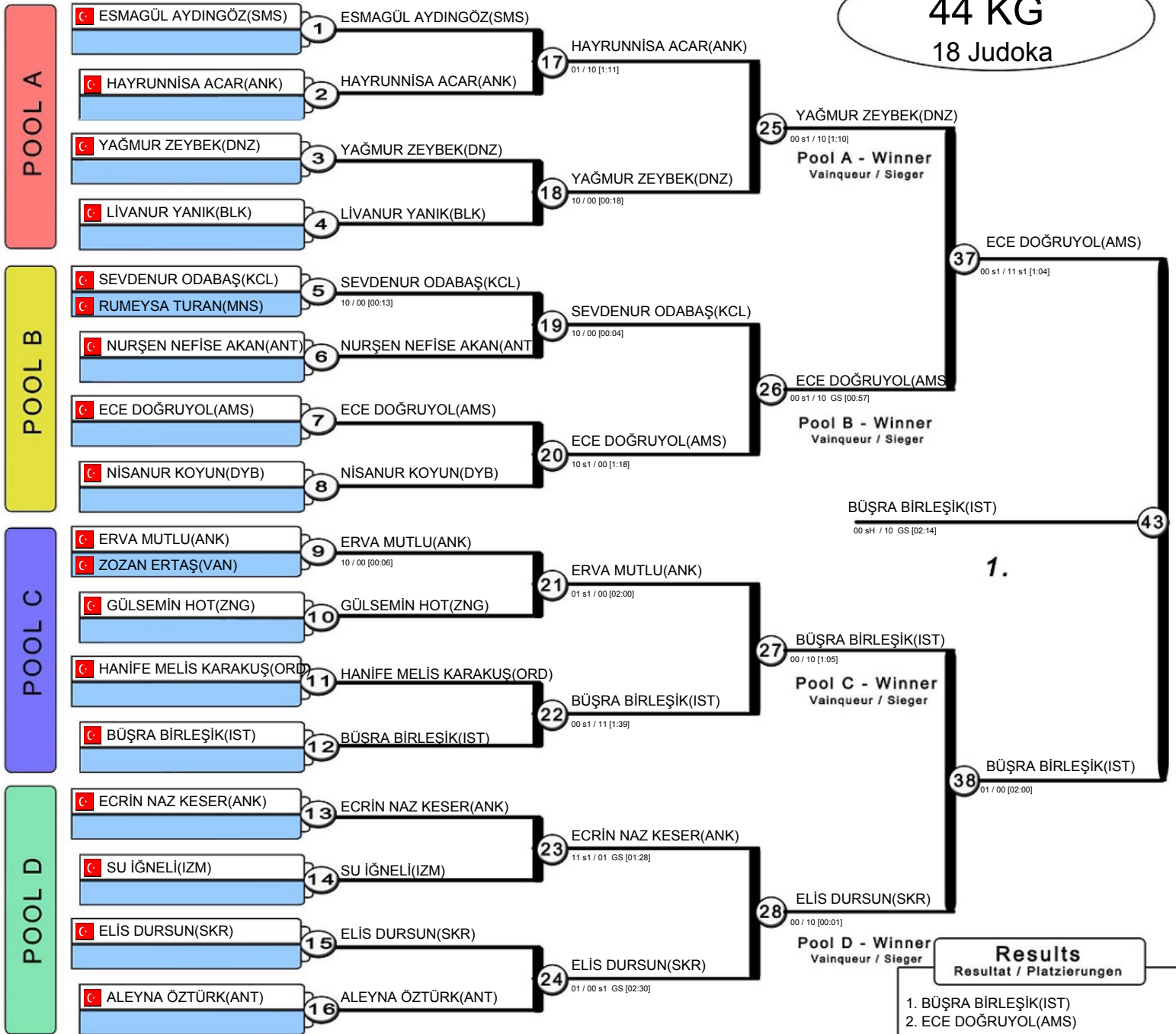



48 KG

17 Judoka

POOL A

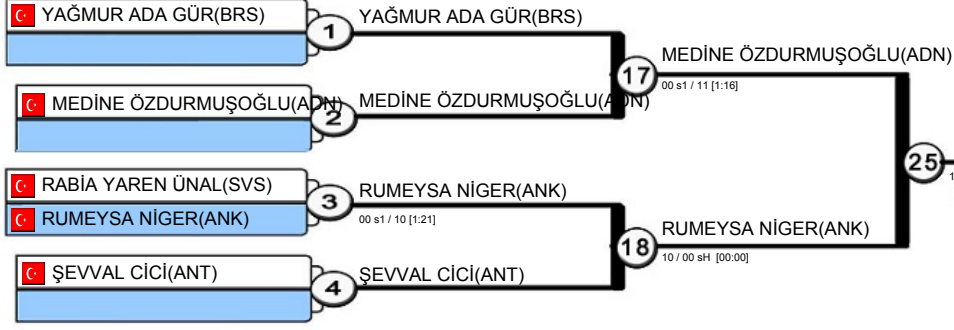

Pool A - Winner  
Vainqueur / Sieger

POOL B

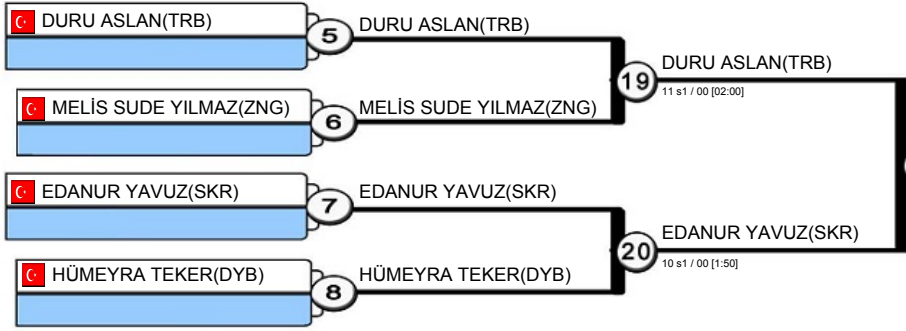

Pool B - Winner  
Vainqueur / Sieger

POOL C

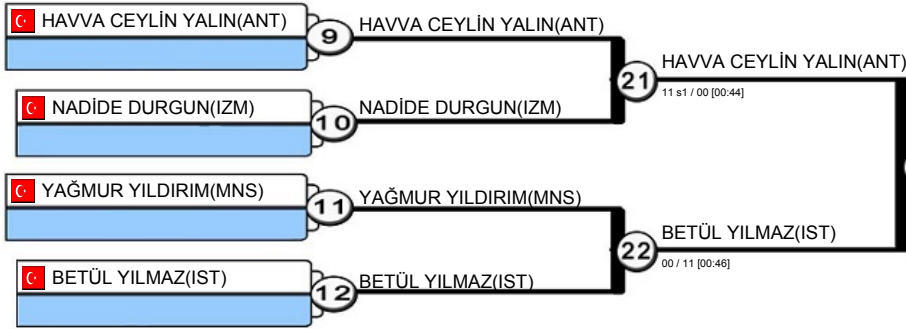

Pool C - Winner  
Vainqueur / Sieger

POOL D

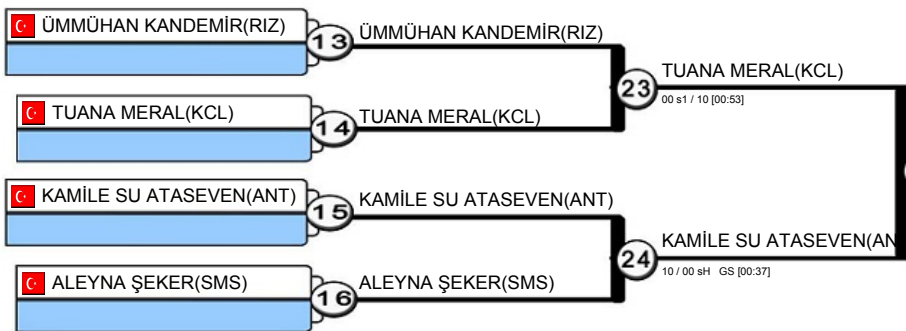

Pool D - Winner  
Vainqueur / Sieger

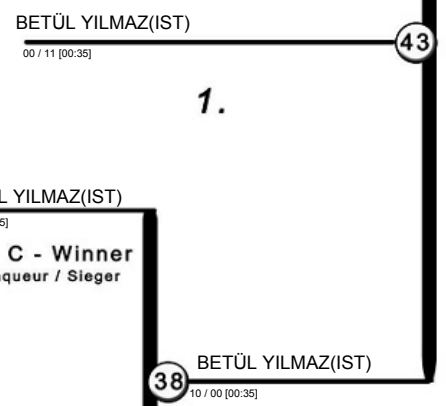

1.

38. BETÜL YILMAZ(IST)

Results  
Resultat / Platzierungen

1. BETÜL YILMAZ(IST)
2. MEDİNE ÖZDURMUŞOĞLU(ADN)
3. ALEYNA ŞEKER(SMS)
5. HÜMEYRA TEKER(DYB)
5. EDANUR YAVUZ(SKR)
7. YAĞMUR YILDIRIM(MNS)
7. RUMEYSA NİGER(ANK)

Repechage / Trostrunde

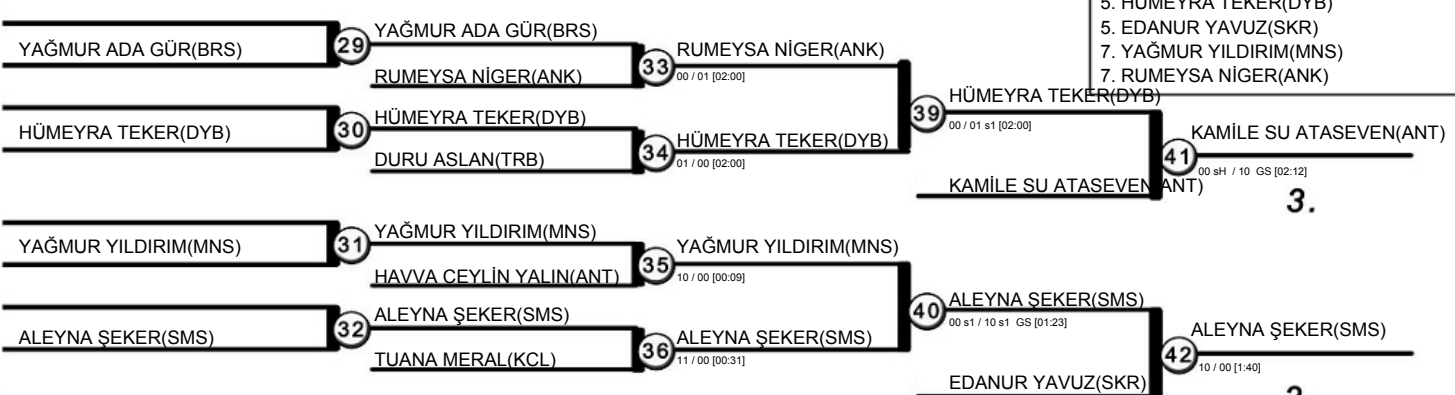

3.

3.

52 KG

16 Judoka

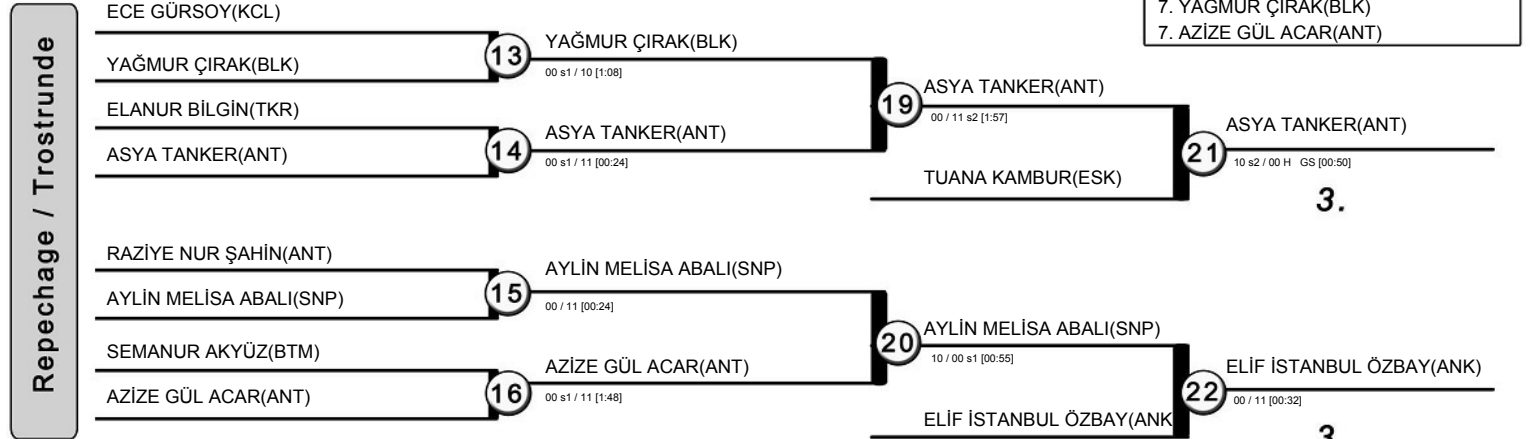
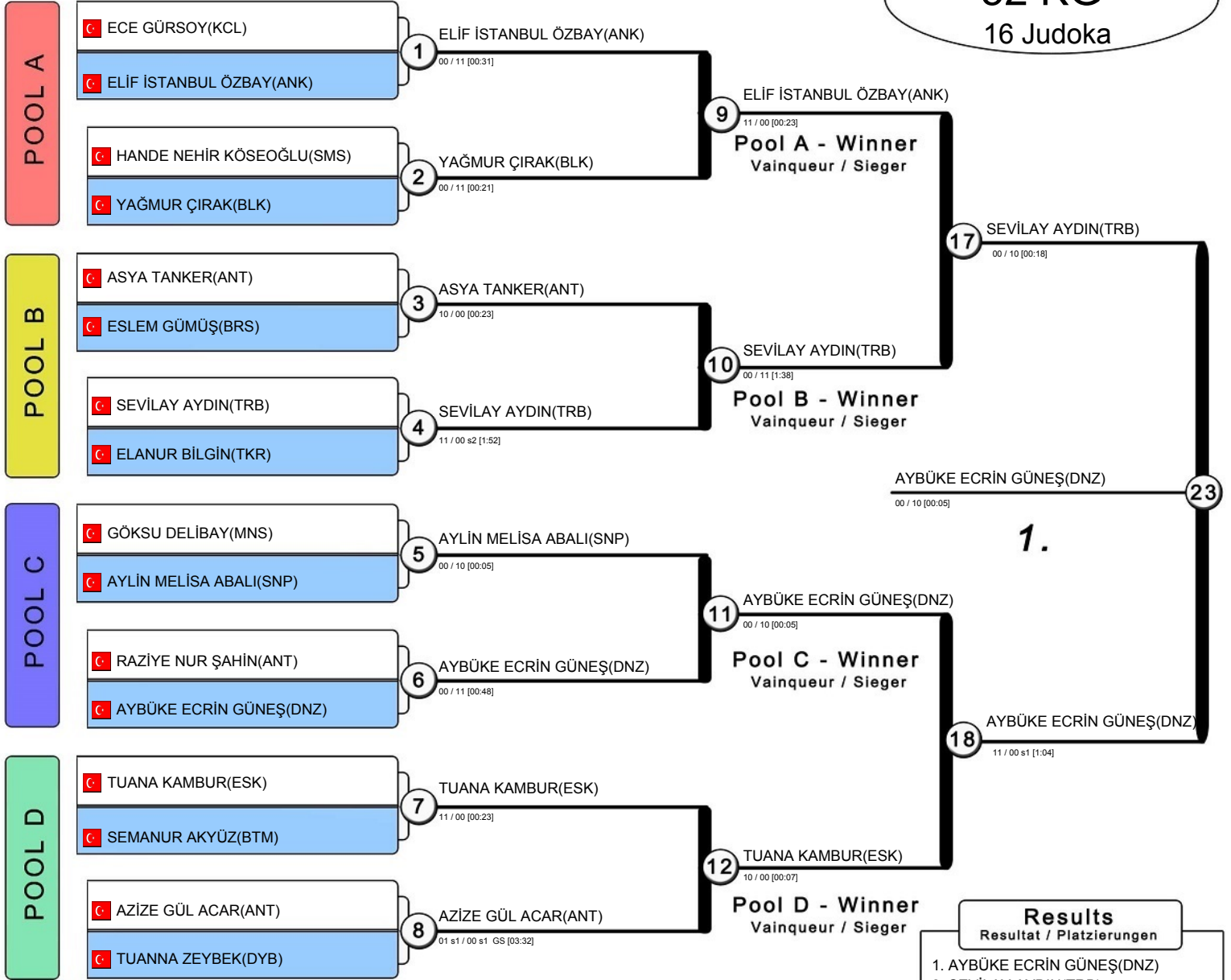

57 KG

14 Judoka

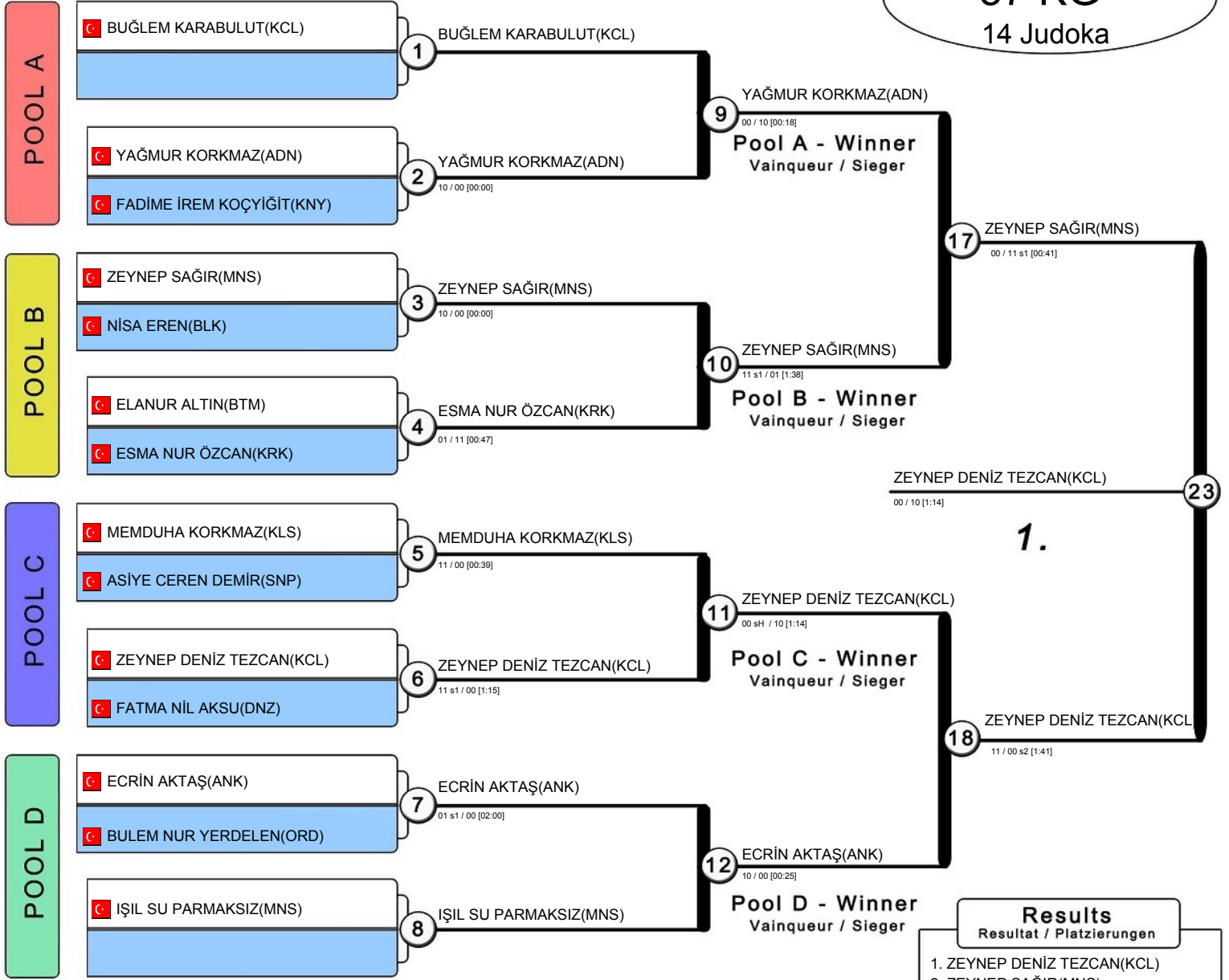

Results	
Resultat / Platzierungen	
1.	ZEYNEP DENİZ TEZCAN(KCL)
2.	ZEYNEP SAĞIR(MNS)
3.	YAĞMUR KORKMAZ(ADN)
3.	ESMA NUR ÖZCAN(KRK)
5.	ECRİN AKTAŞ(ANK)
5.	MEMDUHA KORKMAZ(KLS)
7.	BUĞLEM KARABULUT(KCL)
7.	BULEM NUR YERDELEN(ORD)

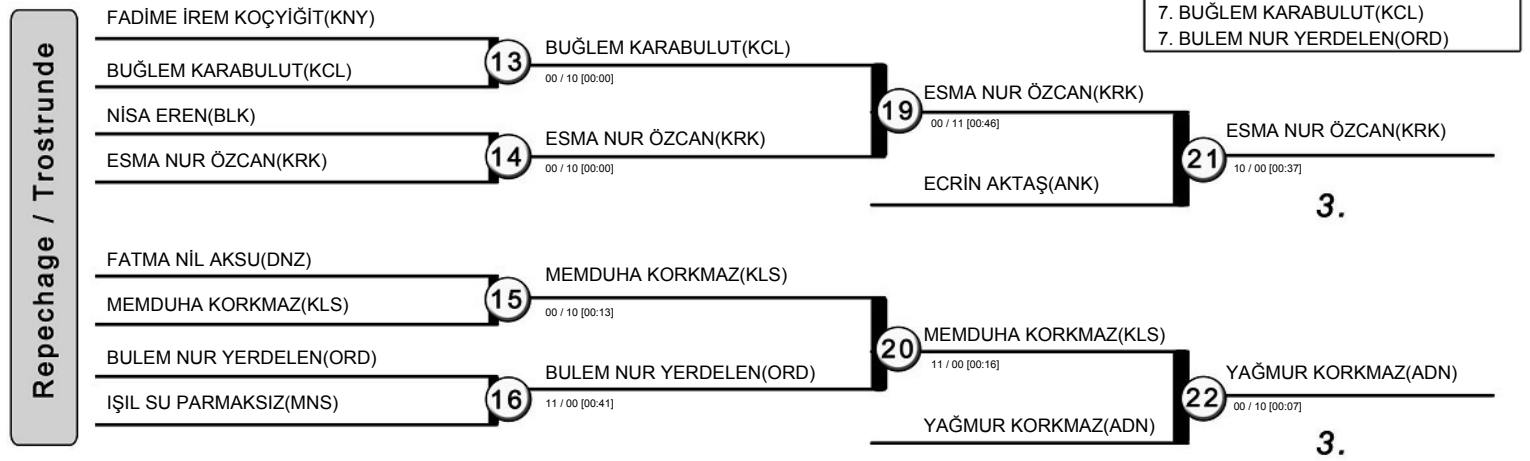

**+57 KG**  
18 Judoka

