

POOL A

	GOMEZ ANTONA Gemma Maria	ESP
	GIORGI Giulia	ITA
	VEG Luca	HUN
	ALIYEVA Konul	AZE
	ERSIN Sila	TUR

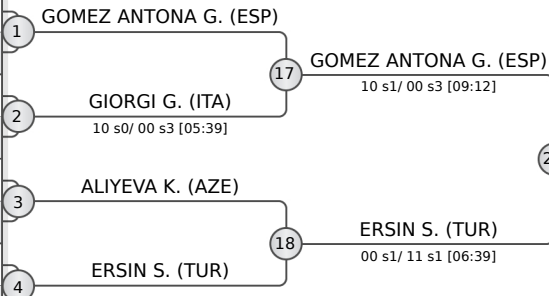

POOL B

	CUQ Pauline	FRA
	VAINSHTEIN Sindi	ISR
	RIADI Nohade	NED
	BERES Lea	FRA
	MOLDOVEANU Iulia	ROU
	ONYSK Oliwia	POL

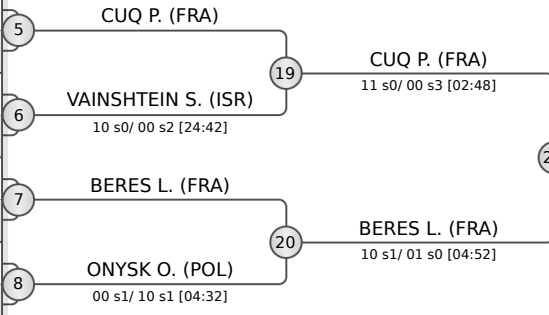

POOL C

	AVANZATO Asia	ITA
	HAGIANU Giorgia	ROU
	PEREZ SOLER Eva	ESP
	RODONAIA Julieta	GEO
	ARSHAKYAN Vilena	EST

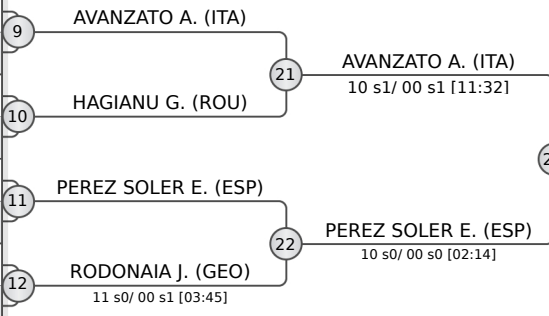

POOL D

	AZAK Merve	TUR
	BODNAROVA Tereza	CZE
	KOSZEGI Rebeka Rita	HUN
	STOKLOSA Natalia	POL
	BRITO Raquel	POR

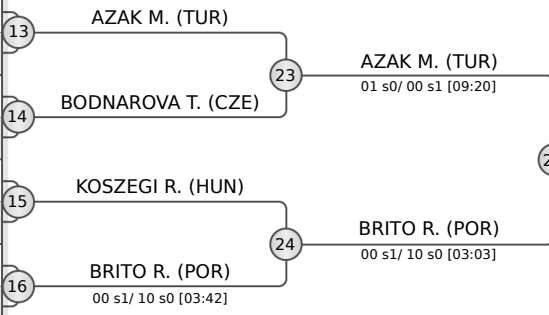

REPECHAGE

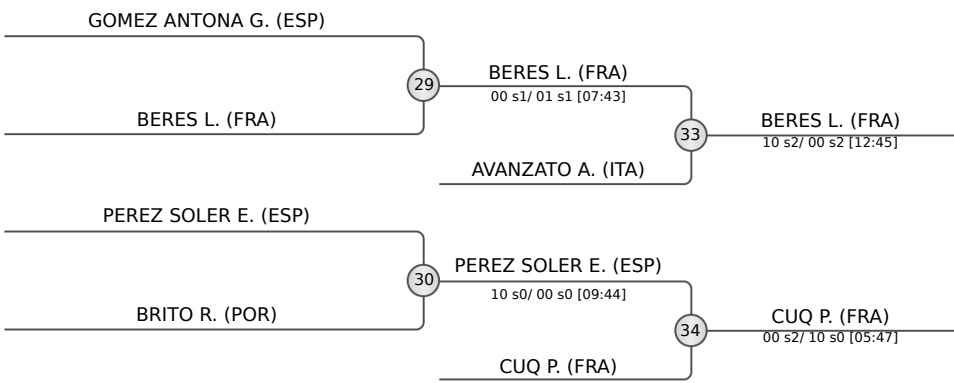

AZAK M. (TUR) 35
00 s2/ 01 s2 [12:59]

AZAK M. (TUR) 32
00 s1/ 01 s1 [05:15]

FINAL RESULTS		
1.	AZAK Merve	TUR
2.	ERSIN Sila	TUR
3.	CUQ Pauline	FRA
3.	BERES Lea	FRA
5.	PEREZ SOLER Eva	ESP
5.	AVANZATO Asia	ITA
7.	GOMEZ ANTONA Gemma Maria	ESP
7.	BRITO Raquel	POR

POOL A

	DEVICTOR Chloe	FRA
	MAMIRA Luca	HUN
	MIHHAILOVA Darja	EST
	KEEN Tatum	GBR
	RAAB Yarden	ISR
	TORTORICI Alessia	ITA

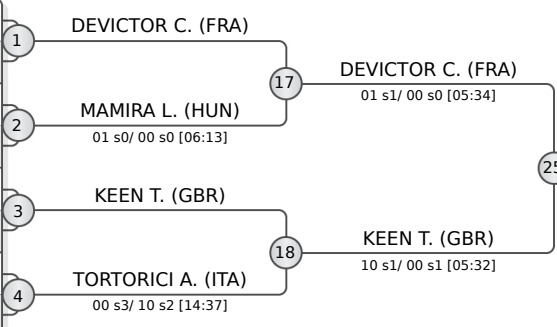

POOL B

	STAKHOV Nicole	GER
	POTSKHVERASHVILI Mariami	GEO
	HORAKOVA Veronika, CZE	CZE
	MUMINOVIQ Erza	KOS
	KALNYTSKA OIha	UKR
	SICKINGER Larissa	AUT

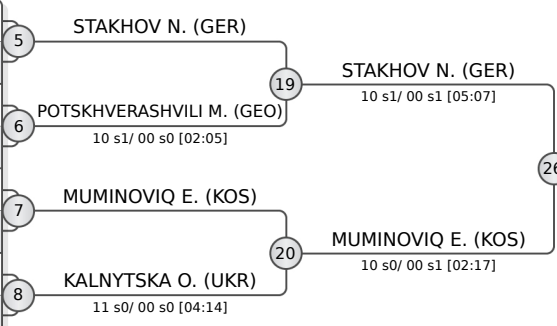

POOL C

	CASTELLO DIEZ Marina	ESP
	NISAVIC Nikolina	SRB
	LAVY Ruth	ISR
	DE CARVALHO Alya	FRA
	KOCYIGIT Ilayda Merve	TUR
	JENMAN Charlotte	GBR

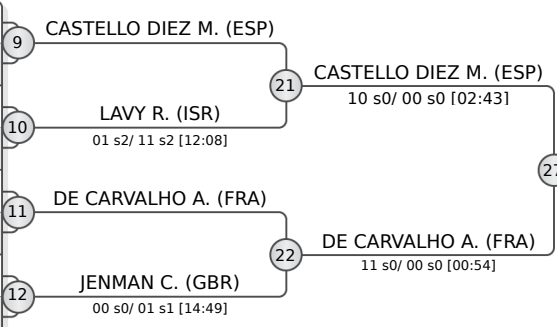

POOL D

	KELLER Rebeka	HUN
	DJERIOU Lena	GER
	PETROVIC Mila	BIH
	TORO SOLER Ariane	ESP
	SALONEN Pihla	FIN
	CATANA Luciana	ROU

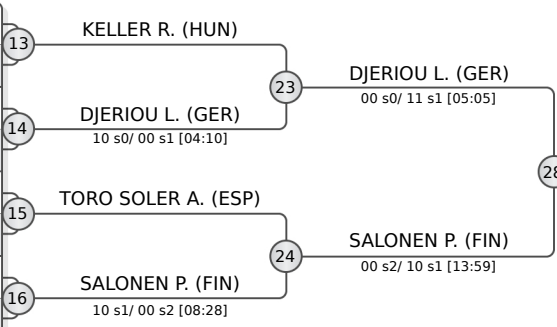

REPECHAGE

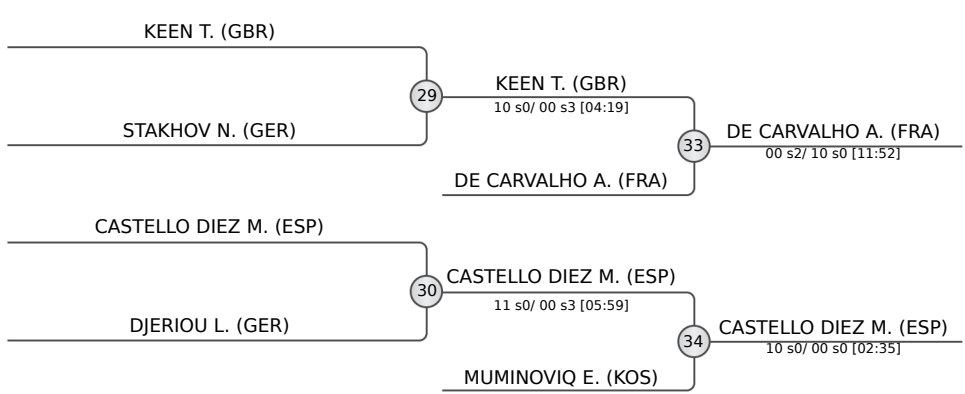

FINAL RESULTS	
1.	SALONEN Pihla
2.	DEVICTOR Chloe
3.	CASTELLO DIEZ Marina
3.	DE CARVALHO Alya
5.	MUMINOVIQ Erza
5.	KEEN Tatum
7.	STAKHOV Nicole
7.	DJERIOU Lena

POOL A

	YILDIZ Ozlem	TUR
	CHYZHEVSKA Anastasiia	UKR
	PAPADOPOULOU Christina	GRE
	BEURSKENS Julie	NED
	NURM Anna Liisa	EST
	LAIHO Venla	FIN
	BAMBERGER Julia	AUT

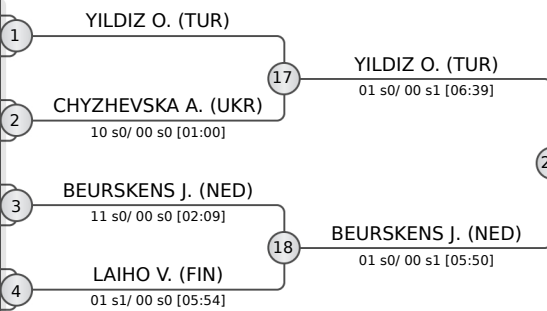

POOL B

	HENNINGER Elin	NED
	BOGNAR Inez	HUN
	TSIKLAURI Nino	GEO
	ALIYEVA Sabina	AZE
	AVANZATO Carlotta	ITA
	RODRIGUEZ SALVADOR Adriana	ESP
	SOKIRJANSKA Anastasija	LAT
	SKRABL Ana	SLO

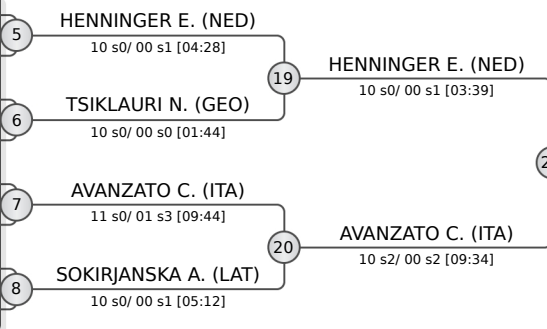

POOL C

	GARCIA MARTIN Marta	ESP
	BAUER Bettina	GER
	TAKAHASHI Ammi	GBR
	HIDEN Verena	AUT
	DORI Romi	ISR
	PAPASTERGIOU Martha	GRE
	NDIAYE Binta	SUI

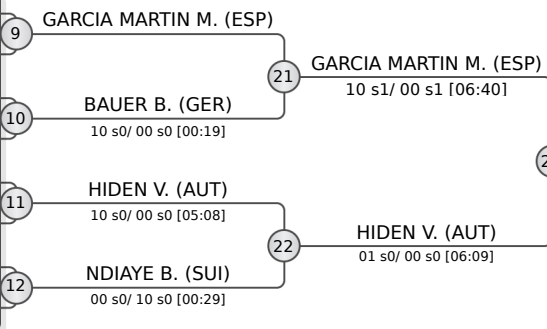

POOL D

	ZUCCARO Chiara	ITA
	GJAKOVA Debora	KOS
	TOLEA Vanessa	ROU
	LOLADZE Nino	GEO
	FAWAZ Martha	FRA
	GRANBERG Tova	SWE
	POLNICKA Marie	CZE
	TARKUS Merit	EST

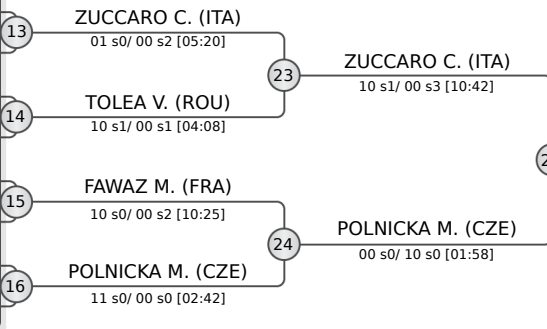

REPECHAGE

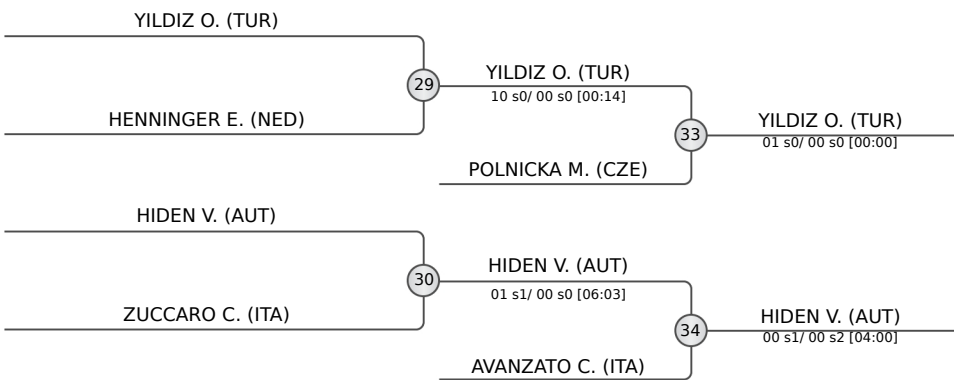

BEURSKENS J. (NED) 10 s0/ 00 s0 [03:40] 35

GARCIA MARTIN M. (ESP) 01 s0/ 00 s1 [06:56] 32

FINAL RESULTS

1.	BEURSKENS Julie	NED
2.	GARCIA MARTIN Marta	ESP
3.	YILDIZ Ozlem	TUR
3.	HIDEN Verena	AUT
5.	POLNICKA Marie	CZE
5.	AVANZATO Carlotta	ITA
7.	HENNINGER Elin	NED
7.	ZUCCARO Chiara	ITA

POOL A

	VAZQUEZ FERNANDEZ Laura	ESP
	KRIZA Anna	HUN
	SIMIC Nina	CRO
	KALLINGER Laura	AUT
	LISCIANI Sara	ITA
	FIZELOVA Ema	SVK
	PALKA Agata	POL

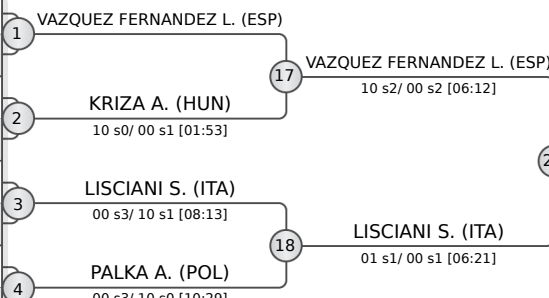

POOL B

	CORRAO Alessia	BEL
	GARDASHKHANLI Aytaj	AZE
	NOACK Nele	GER
	NALBAT Kamile	NED
	AFYONLU Habibe	TUR
	BRAS Margarida	POR

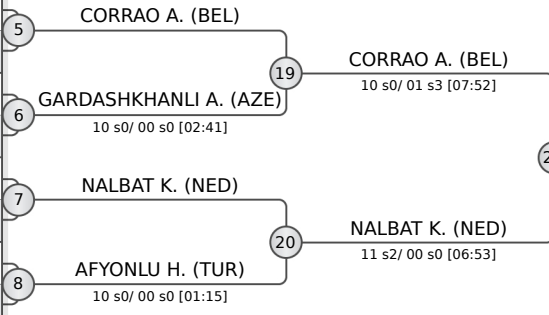

POOL C

	AUCHECORNE Melkia	FRA
	FILIPOVIC Ines	CRO
	SKALSKA Anna	CZE
	FOLGER Viktoria	GER
	NOVITZKI Adelina	ISR
	KRAFT Pia-Jacqueline	AUT
	KOZLJAK Dzejla	BIH

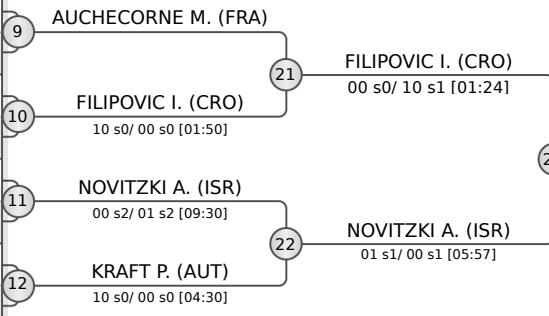

POOL D

	ZUCCO Agnese	ITA
	VIT Lili	HUN
	YEKSAN Ayten	TUR
	IVANESCU Florentina	ROU
	ASKILASHVILI Eter	GEO
	NISAVIC Kristina	SRB

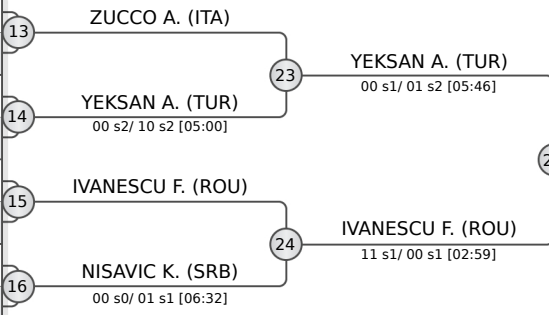

REPECHAGE

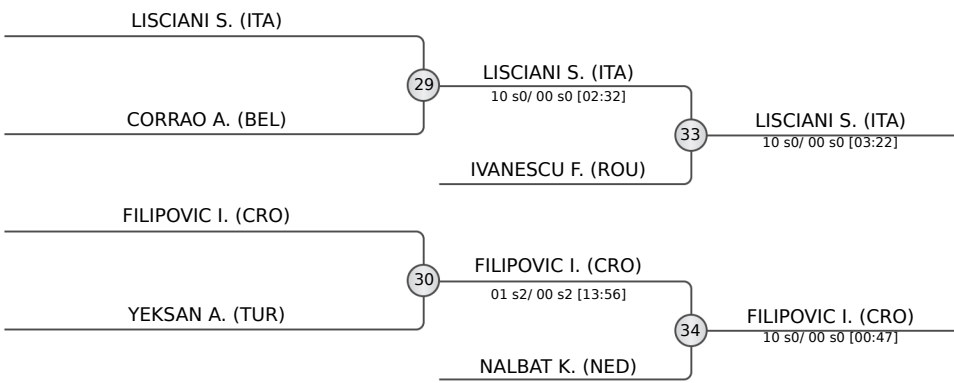

FINAL RESULTS		
1.	VAZQUEZ FERNANDEZ Laura	ESP
2.	NOVITZKI Adelina	ISR
3.	FILIPOVIC Ines	CRO
3.	LISCIANI Sara	ITA
5.	NALBAT Kamile	NED
5.	IVANESCU Florentina	ROU
7.	YEKSAN Ayten	TUR
7.	CORRAO Alessia	BEL

POOL A

	OZTURK Hilal	TUR
	MARIC Sara	BIH
	AKTAS Emma-Melis	EST

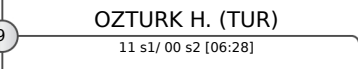
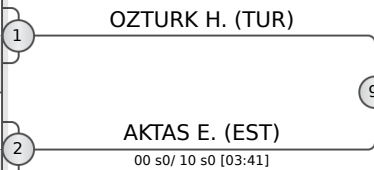

POOL B

	NACER Dounia	FRA
	NORCIC Nicki	SLO

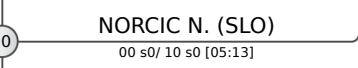
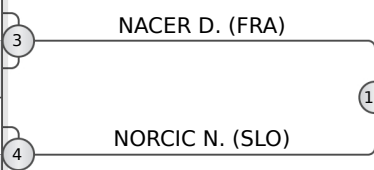

POOL C

	DIJKSTRA Carmen	NED
	DIRGEN Duygu	TUR
	ZHELEZARSKA Irina	BUL

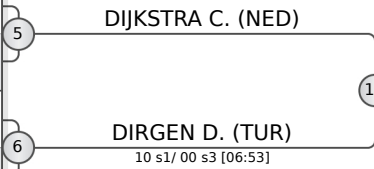

POOL D

	TAVANO Asya	ITA
	DIACENCO Oxana	MDA
	VULPASIN Maria-Nicoleta	GRE

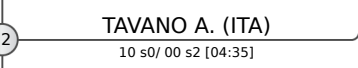
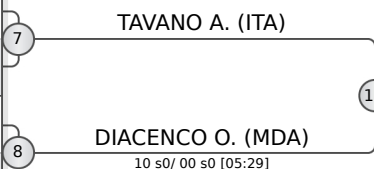

FINAL RESULTS		
1.	OZTURK Hilal	TUR
2.	TAVANO Asya	ITA
3.	DIJKSTRA Carmen	NED
3.	DIACENCO Oxana	MDA
5.	NACER Dounia	FRA
5.	NORCIC Nicki	SLO
7.	AKTAS Emma-Melis	EST
7.	DIRGEN Duygu	TUR

REPECHAGE

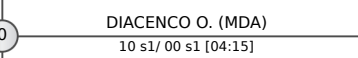
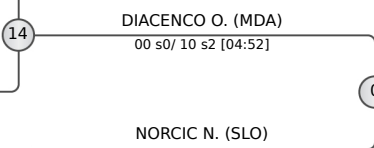
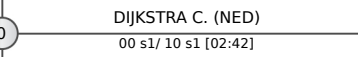
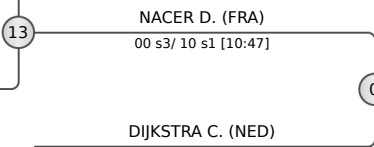
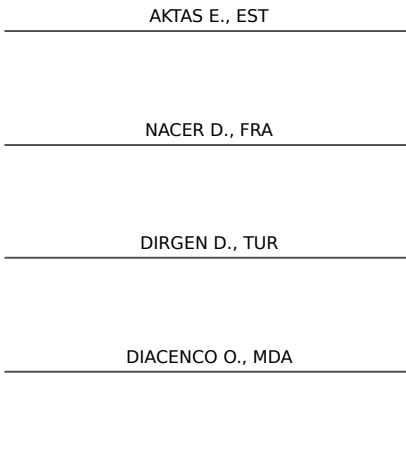



European Judo Championships Juniors Prague 2022

Czech Republic, Prague, 15-17 Sep 2022

-60 KG

Juniors (30)

POOL A

	BAYRAMOV Turan	AZE
	GUSTIUC Cristian	MDA
	BAHADIR Berat	TUR
	FARKAS Bence	HUN
	KLEINOS Anton	POL
	BURK Lenny Linus	GER
	BARROSO LOPEZ Luis	ESP

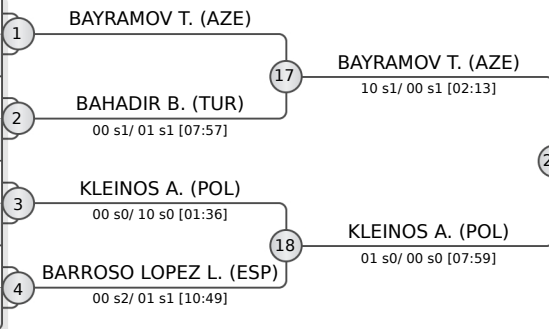

POOL B

	AUER Marcus	AUT
	ANGHEL Andrei	ROU
	VISKOV Nazar	UKR
	VEKSLER Yehonatan, ISR	ISR
	JEAN Enzo	FRA
	PARLATI Manuel	ITA
	PAPASTERGIOU Nikolaos	GRE
	SIMEONOV Ivan	BUL

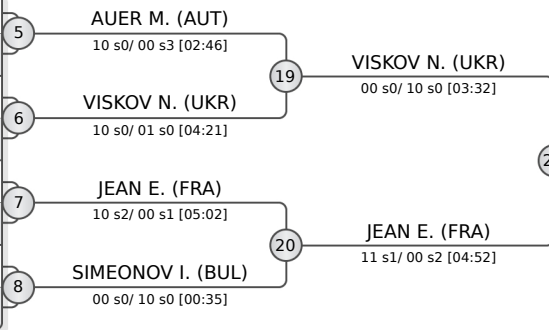

POOL C

	MAZIASHVILI Tornike	GEO
	IMRANOV Nizami	AZE
	PIRES Ricardo	POR
	IGNASIAK Ksawery	POL
	RADOVIC Petar	MNE
	MULALIC Ahmed	BIH
	BADALYAN Martin	ARM

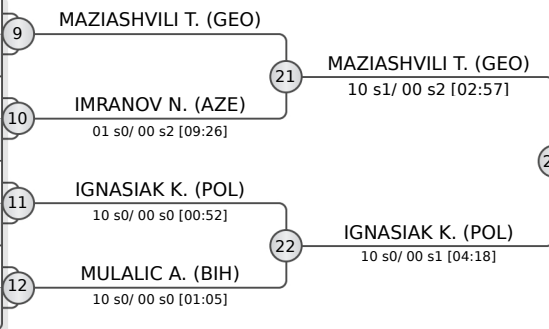

POOL D

	WOLCZAK Yam	ISR
	ANASTASOPOULOS Adam	GRE
	ANDJELOVIC Rastko	SRB
	VAN HARTEN Jochem	NED
	MATEI Alexandru	ROU
	HRISTOV Hristo	BUL
	GOC Uluer	TUR
	MAJOR Adam	HUN

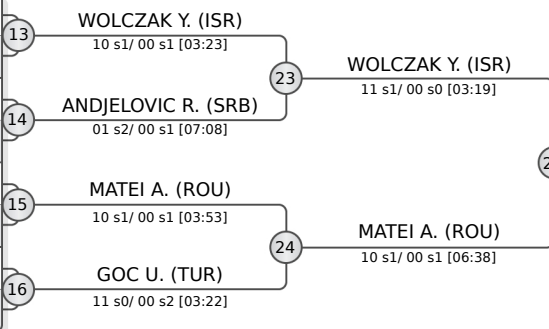

REPECHAGE

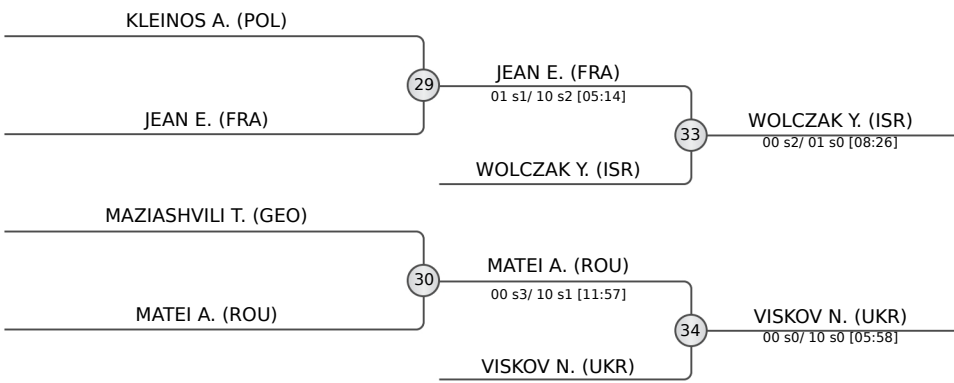

FINAL RESULTS	
1.	IGNASIAK Ksawery (POL)
2.	BAYRAMOV Turan (AZE)
3.	VISKOV Nazar (UKR)
3.	WOLCZAK Yam (ISR)
5.	MATEI Alexandru (ROU)
5.	JEAN Enzo (FRA)
7.	KLEINOS Anton (POL)
7.	MAZIASHVILI Tornike (GEO)





European Judo Championships Juniors Prague 2022

-66 KG

Czech Republic, Prague, 15-17 Sep 2022

Juniors (37)

POOL A

	DEMIREL Muhammed	TUR
	WALDSBERGER Tomas	CZE
	SZYMANSKI Szymon	POL
	FERNANDES B. Tralhao	POR
	FURST CRTANEC Tobias	SLO
	KOKOLAYEV Ronald	ISR
	GABOR Aron	HUN
	MICHAILIDIS Alexios	GRE
	YOTOV Boyan	BUL

1	DEMIREL M. (TUR)	33	DEMIREL M. (TUR)
2	WALDSBERGER T. (CZE)		10 s0/ 00 s0 [02:28]
3	FERNANDES B. (POR)	34	FERNANDES B. (POR)
4	FURST CRTANEC T. (SLO)		10 s0/ 00 s0 [02:55]
5	KOKOLAYEV R. (ISR)	35	KOKOLAYEV R. (ISR)
6	GABOR A. (HUN)		11 s0/ 01 s3 [04:20]
7	MICHAILIDIS A. (GRE)	36	YOTOV B. (BUL)
8	YOTOV B. (BUL)		00 s3/ 10 s0 [06:11]

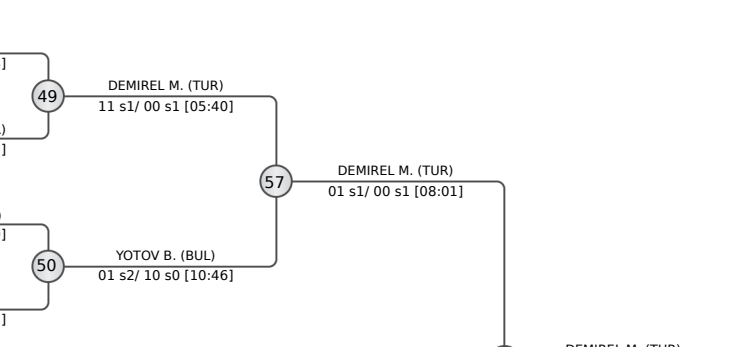

POOL B

	ACCOGLI Valerio	ITA
	OSMANOV ALIM	MDA
	DEMETS Robbe	BEL
	ZIRAKASHVILI Teng	GEO
	ABRAHAMIAN Davit	ARM
	DZITAC Ioan	ROU
	LAVRSEN Bertil	DEN
	ROGNVALDSSON Ingolfur	ISL
	ANTELIJ Srdjan	SRB
	KUNZE Nicolas	GER

9	ACCOGLI V. (ITA)	37	DEMETS R. (BEL)
10	OSMANOV ALIM		00 s1/ 01 s1 [06:23]
11	ZIRAKASHVILI T. (GEO)	38	ZIRAKASHVILI T. (GEO)
12	ABRAHAMIAN D. (ARM)		01 s1/ 00 s2 [06:01]
13	DZITAC I. (ROU)	39	DZITAC I. (ROU)
14	LAVRSEN B. (DEN)		11 s0/ 00 s1 [05:56]
15	ANTELIJ S. (SRB)	40	ANTELIJ S. (SRB)
16	KUNZE N. (GER)		01 s0/ 00 s0 [05:58]

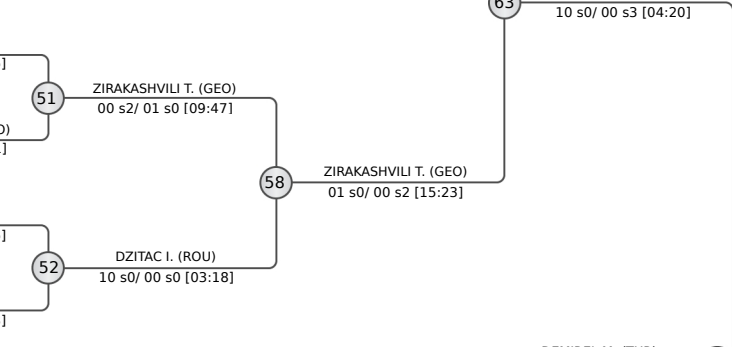

POOL C

	GOMBAS Balint	HUN
	GAGO Miguel	POR
	KASRADZE Aleko	GEO
	KOKALJ Gasper	SLO
	MOUNDANGA Maxime	FRA
	NORKEVICIUS Matas	LTU
	ALTEMIROV Deny	BEL
	LIPARD Viljar	EST
	DEMIREL Ibrahim	TUR

17	GOMBAS B. (HUN)	41	GOMBAS B. (HUN)
18	GAGO M. (POR)		01 s1/ 00 s1 [13:05]
19	KASRADZE A. (GEO)	42	KASRADZE A. (GEO)
20	KOKALJ G. (SLO)		01 s1/ 00 s1 [06:16]
21	MOUNDANGA M. (FRA)	43	MOUNDANGA M. (FRA)
22	ALTEMIROV D. (BEL)		00 s2/ 01 s0 [07:25]
23	LIPARD V. (EST)	44	DEMIREL I. (TUR)
24	DEMIREL I. (TUR)		01 s0/ 11 s0 [02:22]

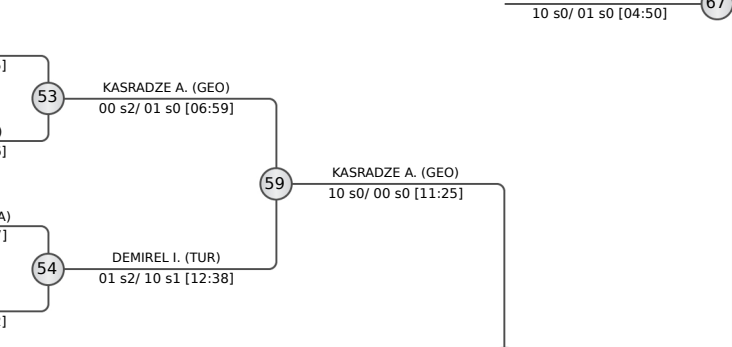

POOL D

	MASSON JBILOU Driss	FRA
	ZOROTOVIC Nikola	CRO
	DARBINYAN Styopa	ARM
	ICKES David	GER
	IZVOREANU Radu	MDA
	BROVOLD Gustav	NOR
	DVORACEK Antonin	CZE
	BRIOLAS Vasileios	GRE
	DYSHEL David	ISR

25	MASSON JBILOU D. (FRA)	45	MASSON JBILOU D. (FRA)
26	ZOROTOVIC N. (CRO)		10 s0/ 00 s1 [04:28]
27	DARBINYAN S. (ARM)	46	ICKES D. (GER)
28	ICKES D. (GER)		00 s0/ 10 s0 [02:30]
29	IZVOREANU R. (MDA)	47	BROVOLD G. (NOR)
30	BROVOLD G. (NOR)		00 s0/ 10 s1 [03:46]
31	DVORACEK A. (CZE)	48	DVORACEK A. (CZE)
32	DYSHEL D. (ISR)		10 s1/ 00 s0 [08:48]

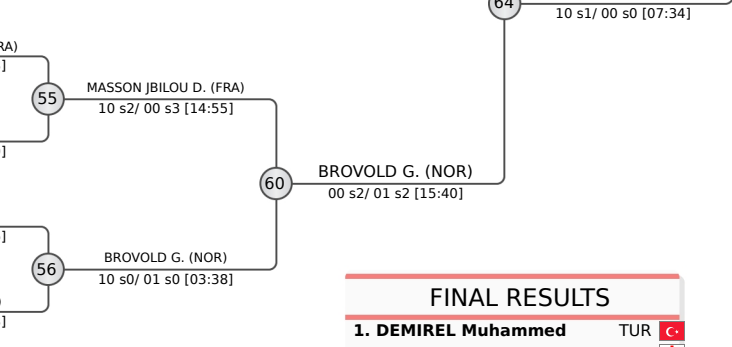

REPECHAGE

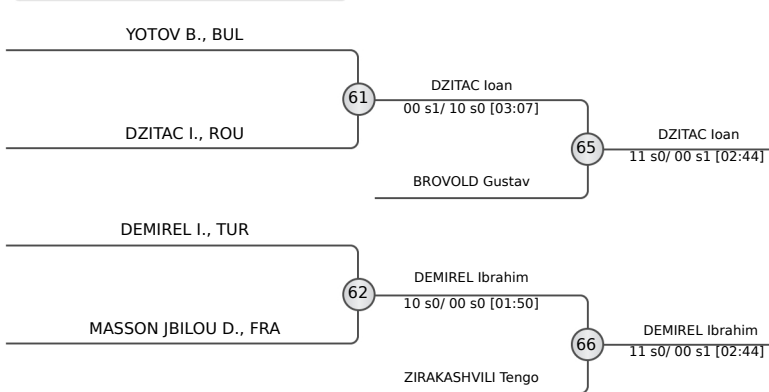

FINAL RESULTS

1.	DEMIREL Muhammed	TUR	
2.	KASRADZE Aleko	GEO	
3.	DZITAC Ioan	ROU	
3.	DEMIREL Ibrahim	TUR	
5.	BROVOLD Gustav	NOR	
7.	ZIRAKASHVILI Teng	GEO	
7.	YOTOV Boyan	BUL	
7.	MASSON JBILOU Driss	FRA	





European Judo Championships Juniors Prague 2022

Czech Republic, Prague, 15-17 Sep 2022

-81 KG

Juniors (33)

POOL A

	AREGBA Arnaud	FRA
	RAPOSO Pedro	POR
	ZUBOVIC Stefan	SRB
	WASIKOWSKI Michal	POL
	HEBIB Mustafa	BIH
	KORCHEMLIUK Stanislav	UKR
	ROZIC Dominik	CRO
	ZEILA Matiss	LAT

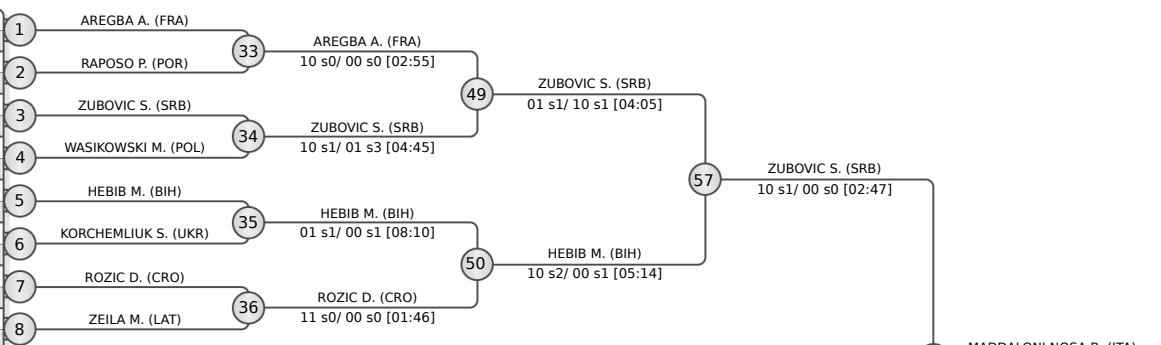

POOL B

	MADDALONI NOSA Bright	ITA
	FASCHING Bernd	AUT
	SIMSEK Musa	TUR
	MATTSSON Pelle	SWE
	BONFERRONI Aurelien	SUI
	KOLEV Georgi	BUL
	PAASTEL Randel	EST
	RAJABLI Omar	AZE

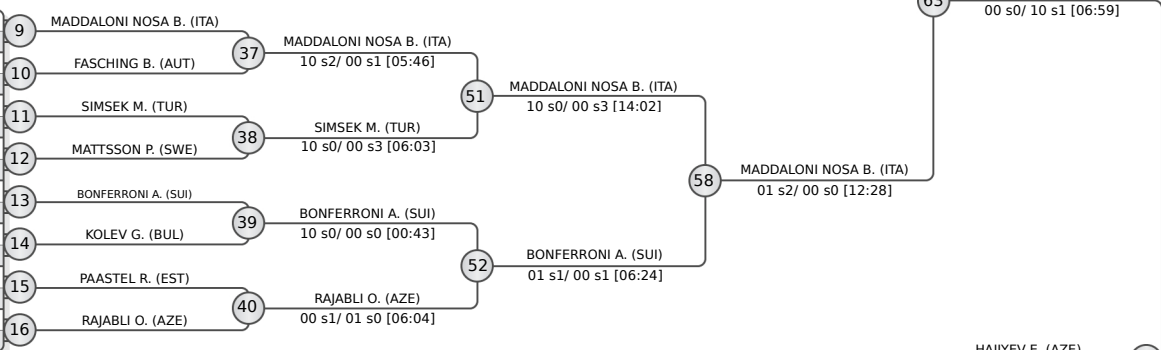

POOL C

	HAIJIYEV Eljan	AZE
	JANCER Marko	MNE
	GEROSA Loic	SUI
	MIHALOVVS Ivans	LAT
	JABNIASHVILI Giorgi	GEO
	DUYCK Jarne	BEL
	KOSOVIC Velimir	SRB
	PILT Karl-Johannes	EST
	SZTANKO Daniel	HUN

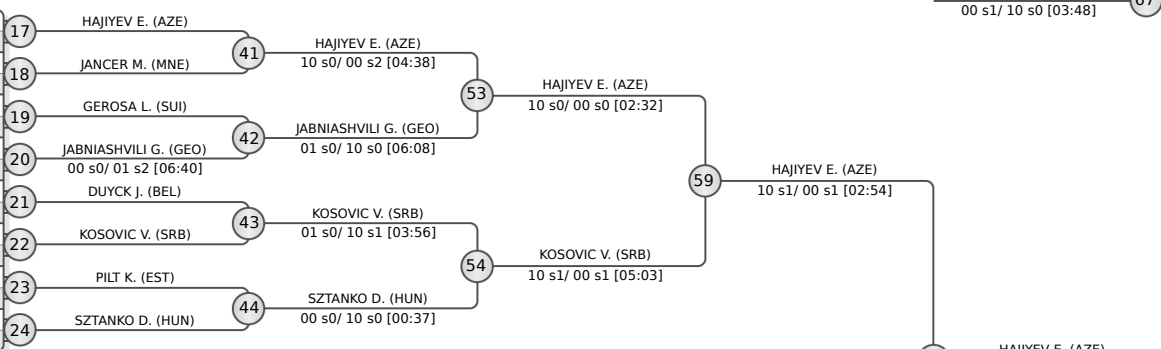

POOL D

	KOPECKY Adam	CZE
	KLYMOV Vsevolod	UKR
	KAPSOUROS Marios	GRE
	RANGEL Diogo	POR
	IVANKA Filip	CZE
	MRKOVIC Lovre	CRO
	VALKOV Hristo	BUL
	KARAPETYAN Gor	ARM

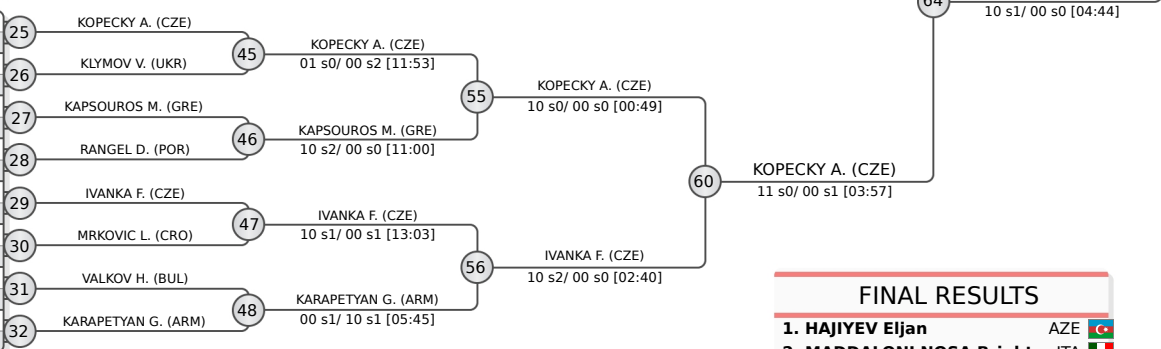

REPECHAGE

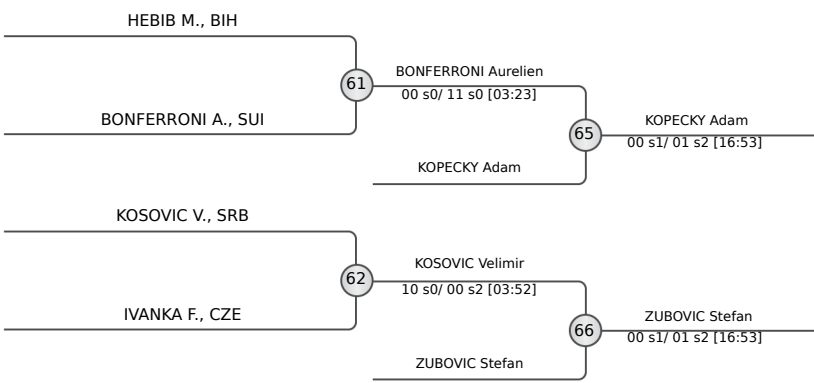

FINAL RESULTS

- HAIJIYEV Eljan** AZE
- MADDALONI NOSA Bright** ITA
- ZUBOVIC Stefan** SRB
- KOPECKY Adam** CZE
- KOSOVIC Velimir** SRB
- BONFERRONI Aurelien** SUI
- IVANKA Filip** CZE
- HEBIB Mustafa** BIH





European Judo Championships Juniors Prague 2022

Czech Republic, Prague, 15-17 Sep 2022

-90 KG

Juniors (32)

POOL A

	SAFRANY Peter	HUN
	PURNAT Nik	SLO
	VLADOV Borislav	BUL
	ALI David	FRA
	RADULJ Miljan	SRB
	VAN HERK Ian	NED
	BONGIORNO Emilio Tindaro	ITA
	ARSENIE Rares	ROU

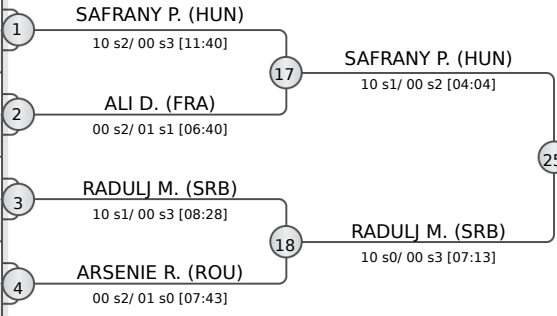

POOL B

	POLADISHVILI Tornike	GEO
	PFAF Michal	CZE
	HASIC Kerim	BIH
	IVANIAN David, DEN	DEN
	TALIBOV Vugar	AZE
	DUINOVS Maksims	LAT
	VALIEIEV Tymur	UKR
	GABAY Inbar	ISR

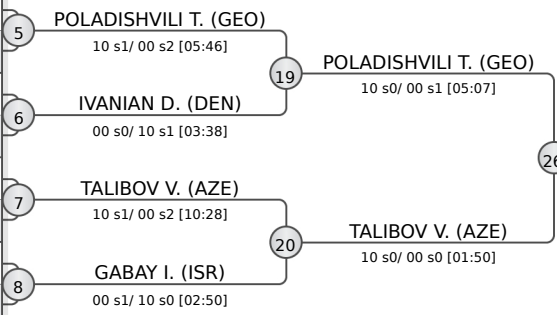

POOL C

	MITROVIC Aleksa	FRA
	KANEVETS Artur	FIN
	MARUSKA Alex	SVK
	ZAMANOV Ismayil	AZE
	PAPOYAN Aslan	AUT
	DROSTE Tom	GER
	DEMIRTAS Cem	TUR
	SAMMARTINO Gabriele	ITA

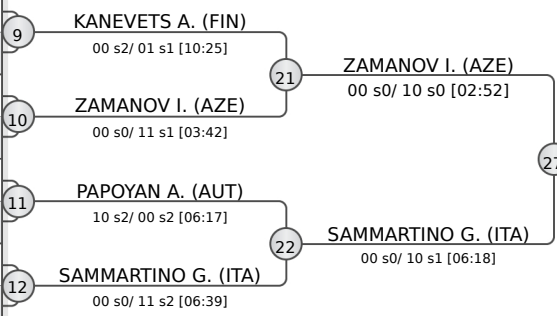

POOL D

	CRET Alex	ROU
	BAATHE Karl	SWE
	SLYTERIS Augustas	LTU
	REIMETS Georg	EST
	SIVAN Roy	ISR
	KUTENKOV Ivan	UKR
	KENDERESI Peter	HUN
	RIJKSEN SALMAN Ryan	GBR

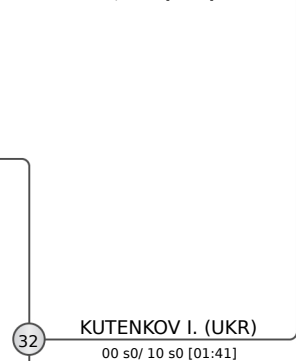
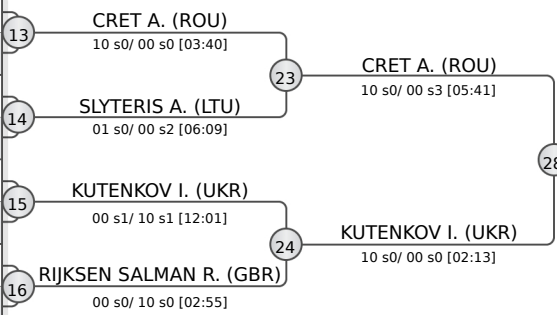

FINAL RESULTS	
1.	TALIBOV Vugar AZE
2.	KUTENKOV Ivan UKR
3.	RADULJ Miljan SRB
3.	ZAMANOV Ismayil AZE
5.	SAMMARTINO Gabriele ITA
5.	SAFRANY Peter HUN
7.	POLADISHVILI Tornike GEO
7.	CRET Alex ROU

REPECHAGE

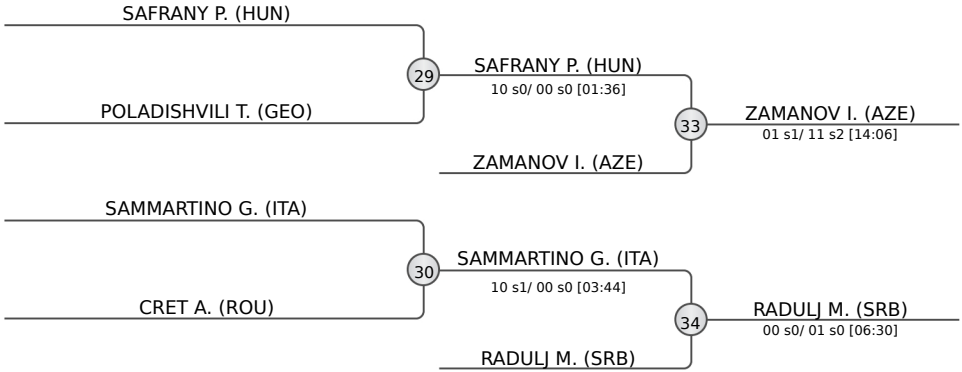



European Judo Championships Juniors Prague 2022

Czech Republic, Prague, 15-17 Sep 2022

+100

Juniors (18)

POOL A

	BLOM Jules	NED
	TABATADZE Ucha	GEO
	ERTUG Munir	TUR
	KEVLISHVILI Davit	ESP
	UDSILAURI Daniel	GER

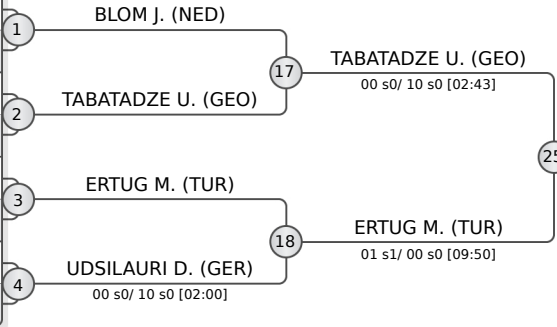

POOL B

	SORDYL Jakub	POL
	RASKA Tomas, CZE	CZE
	NASIBOV Kanan	AZE
	BAGRIN Alin	MDA

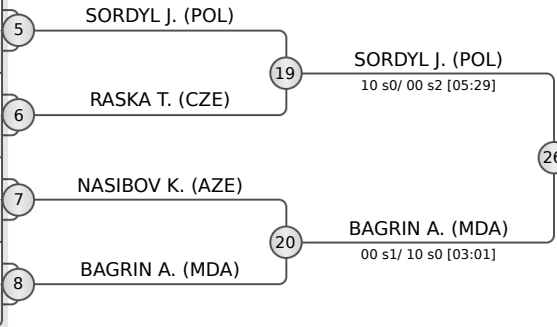

POOL C

	GURESHIDZE Shalva	GEO
	GEORGESCU Darius	ROU
	HALAKA Oleksii	UKR
	ANTONIOU Giannis	CYP

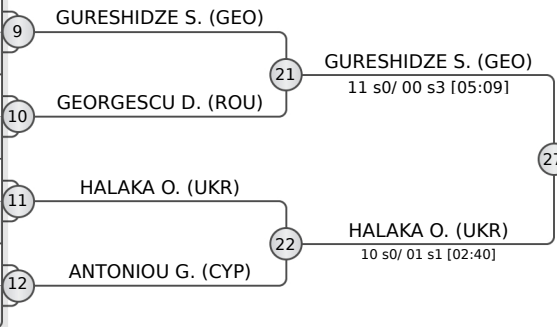

POOL D

	PRIILINN TURK Karl	EST
	PLOEHNERT Paavo	GER
	STOSIC Andrija	SRB
	TERESINSKI Grzegorz	POL
	SAVIC Patrik	BIH

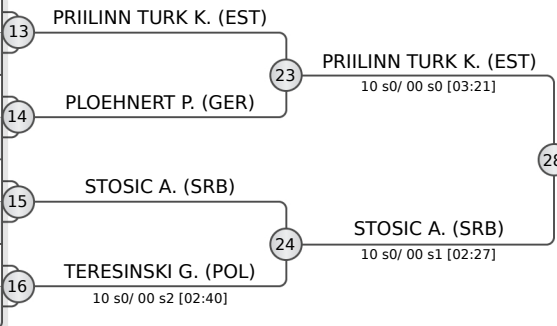

REPECHAGE

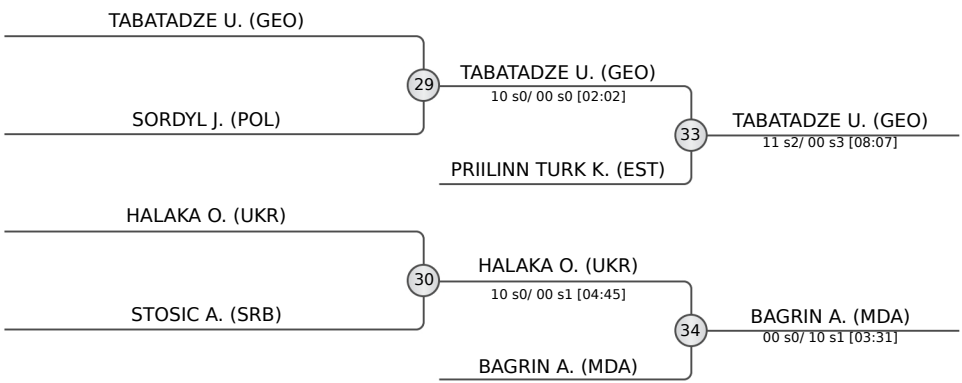

FINAL RESULTS		
1.	GURESHIDZE Shalva	GEO
2.	ERTUG Munir	TUR
3.	BAGRIN Alin	MDA
3.	TABATADZE Ucha	GEO
5.	HALAKA Oleksii	UKR
5.	PRIILINN TURK Karl	EST
7.	SORDYL Jakub	POL
7.	STOSIC Andrija	SRB

