



# European Youth Olympic Festival

Banska Bystrica (SVK), 26-29 Jul 2022

# Men

Final Results

## -55 kg

1.	LOMITASHVILI, Daviti	GEO
2.	ALIYEV, Murad	AZE
3.	AGHASYAN, Vahe	ARM
3.	RUBINSTEIN, Roy	ISR
5.	SYNOLD, Raphael	FRA
5.	TURKMAN, Tuncay	TUR
7.	LAMPREIA, Goncalo	POR
7.	TARAN, Maxim	MDA

## -60 kg

1.	VAN HARTEN, Jochem	NED
2.	KARIMLI, Nurlan	AZE
3.	KARELI, Davit	GEO
3.	VISKOV, Nazar	UKR
5.	BOECKER, Florian	GER
5.	PARLATI, Manuel	ITA
7.	COTON VAZQUEZ, Anderson Dibaris	ESP
7.	IGNASIAK, Ksawery	POL

## -66 kg

1.	DEMIREL, Ibrahim	TUR
2.	FURST CRTANEC, Tobias	SLO
3.	MOSIASHVILI, Tornike	GEO
3.	SORKIN, Robert	ISR
5.	MARINX, Ray	BEL
5.	YUSIFLI, Eltaj	AZE
7.	ER, Altay	DEN
7.	LIWOCHA, Krystian	GER

## -73 kg

1.	DE LANGE, Joshua	NED
2.	SIMIN, Mihajlo	SRB
3.	KAZIMIROV, Ivan	UKR
3.	TOROSYAN, Artak	ARM
5.	NASCHCHO, Issa	AUT
5.	PALEV, Mariyan	BUL
7.	GURGEN, Erman	TUR
7.	KRIZEK, Simon	CZE

## -81 kg

1.	KORCHEMLIUK, Stanislav	UKR
2.	ZAMANOV, Ismayil	AZE
3.	KARAPETYAN, Gor	ARM
3.	ZEILA, Matiss	LAT
5.	PUCHLY, Thomas	FRA
5.	VALKOV, Hristo	BUL
7.	PILT, Karl-Johannes	EST
7.	ZOROTOVIC, Luka	CRO

## -90 kg

1.	RADULJ, Miljan	SRB
2.	PURNAT, Nik	SLO
3.	ARSENIE, Rares	ROU
3.	MAMULASHVILI, Archil	GEO
5.	GABAY, Inbar	ISR
5.	LHOTZKY, Frantisek	CZE
7.	KENDERESI, Peter	HUN
7.	SPERLIDIS, Alexios	GRE

## -100 kg

1.	PETRE, Bogdan	ROU
2.	BASSO, Francesco	ITA
3.	BADUASHVILI, Giorgi	GEO
3.	SCHELL, Joes	NED
5.	BAGHIROV, Azhdar	AZE
5.	SAGHATELYAN, Erik	ARM
7.	BOTOS, Noel	HUN
7.	ILLMER, Hubert	AUT

## +100 kg

1.	TABATADZE, Giorgi	GEO
2.	ERGIN, Recep	TUR
3.	ANTONIOU, Giannis	CYP
3.	NASIBOV, Kanan	AZE
5.	GEORGESCU, Darius	ROU
5.	KLOS, Milosz	POL
7.	NIKITENKO, Nikita	GER
7.	STRAZDINS, Janis	LAT



# European Youth Olympic Festival

Banska Bystrica (SVK), 26-29 Jul 2022

## Women Final Results

### -44 kg

1.	WANDEL, Vera	NED
2.	SZELECZKI, Szabina	HUN
3.	MERMET, Clara	FRA
3.	MUNTSUROVA, Tanzila	AUT
5.	GASIMZADE, Khumar	AZE
5.	KOZUCH, Oliwia	POL
7.	ERTEM, Zilan	TUR
7.	GONCALVES, Matilde	POR

### -48 kg

1.	FINESTRONE, Ilaria	ITA
2.	ALIYEVA, Konul	AZE
3.	HABIB, Helen	GER
3.	SHAW, Summer	GBR
5.	BOGA, Pinar	TUR
5.	RODONAIA, Julieta	GEO
7.	MOLDOVEANU, Iulia	ROU
7.	SIBILLE, Victoria	BEL

### -52 kg

1.	GOMEZ ANTONA, Laura	ESP
2.	NISAVIC, Nikolina	SRB
3.	MAMIRA, Luca	HUN
3.	VALIYEVA, Aydan	AZE
5.	JENMAN, Charlotte	GBR
5.	WALLON, Faustine	FRA
7.	SCERBOVA, Leona	CZE
7.	YILDIRIM, Seyma	TUR

### -57 kg

1.	ALIZADA, Fidan	AZE
2.	BEURSKENS, Julie	NED
3.	BULANDA, Julia	POL
3.	MELIS, Emma	FRA
5.	RODRIGUEZ SALVADOR, Adriana	ESP
5.	SOUTHGATE, Niamh	GBR
7.	LOLADZE, Nino	GEO
7.	NURM, Anna Liisa	EST

### -63 kg

1.	PRIMO, Kerem	ISR
2.	KELEMEN, Adel	HUN
3.	CORBO, Sara	ITA
3.	NOACK, Nele	GER
5.	CABARET, Naomi	FRA
5.	TRETNJAK, Lisa	AUT
7.	LEYSNER, Mika	NED
7.	SIMIC, Nina	CRO

### -70 kg

1.	NILSSON, Ingrid	SWE
2.	DENGG, Elena	AUT
3.	GULBANI, Nino	GEO
3.	KOREN, Nika	SLO
5.	BALOGH, Hanna	ROU
5.	BAR OR, Gaya	ISR
7.	BUDDENKOTTE, Eva Ronja	GER
7.	GIUSTI, Eleonora	ITA

### -78 kg

1.	LYTVYENENKO, Yelyzaveta	UKR
2.	MISHINER, Yuli Alma	ISR
3.	CONCEICAO, Fabia	POR
3.	NIEMEYER, Mathilda Sophie	GER
5.	KAYA, Sumeyye	TUR
5.	STJEPANOVIC, Jovana	SRB
7.	HERIC, Vanessa Asja	SLO
7.	KRAPU, Emma	FIN

### +78 kg

1.	SEMCHENKO, Diana	UKR
2.	LANG, Bintibe	FRA
3.	DE PAOLI, Morgana	ITA
3.		
5.		
5.		
7.		
7.		



# European Youth Olympic Festival

Banska Bystrica (SVK), 26-29 Jul 2022

# Medals

## Total

				1st place	2nd place	3rd place	5th place	7th place
1.		NED	Netherlands	3	1	1	0	1
2.		UKR	Ukraine	3	0	2	0	0
3.		GEO	Georgia	2	0	5	1	1
4.		AZE	Azerbaijan	1	4	2	3	0
5.		SRB	Serbia	1	2	0	1	0
6.		ISR	Israel	1	1	2	2	0
7.		ITA	Italy	1	1	2	1	1
8.		TUR	Turkiye	1	1	0	3	3
9.		ROU	Romania	1	0	1	2	1
10.		ESP	Spain	1	0	0	1	1
11.		SWE	Sweden	1	0	0	0	0
12.		HUN	Hungary		2	1	0	2
13.		SLO	Slovenia		2	1	0	1
14.		FRA	France		1	2	4	0
15.		AUT	Austria		1	1	2	1
16.		GER	Germany			3	1	3
17.		ARM	Armenia			3	1	0
18.		POL	Poland			1	2	1
19.		GBR	Great Britain			1	2	0
20.		POR	Portugal			1	0	2
21.		LAT	Latvia			1	0	1
22.		CYP	Cyprus			1	0	0
23.		BUL	Bulgaria				2	0
24.		CZE	Czech Republic				1	2
25.		BEL	Belgium				1	1
26.		CRO	Croatia					2
26.		EST	Estonia					2
28.		DEN	Denmark					1
28.		FIN	Finland					1
28.		GRE	Greece					1
28.		MDA	Republic of Moldova					1
32.		ALB	Albania					
32.		BIH	Bosnia and Herzegovina					
32.		IRL	Ireland					
32.		ISL	Iceland					
32.		KOS	Kosovo					
32.		LIE	Liechtenstein					
32.		LTU	Lithuania					
32.		LUX	Luxembourg					
32.		MKD	North Macedonia					





# European Youth Olympic Festival

Banska Bystrica (SVK), 26-29 Jul 2022

# Medals

Total

				1st place	2nd place	3rd place	5th place	7th place
32.		<b>NOR</b>	Norway					
32.		<b>SUI</b>	Switzerland					
32.		<b>SVK</b>	Slovakia					

43 nations in this event

43 nations with places 1st-7th ( = 100% )

22 nations with medals ( = 51% )

**-55 kg**

11 Judoka

POOL A

1 **LAMPREIA, Goncalo** POR

9

1 LAMPREIA, G. (POR)

5 **TURKMAN, Tuncay** TUR

13

2 TURKMAN, Tuncay (TUR)

9 **TURKMAN, Tuncay (TUR)**

00 / 10 0:00  
**Pool A - Winner**  
Vainqueur / Sieger

POOL B

3 **AGHASYAN, Vahe** ARM

11

3 AGHASYAN, Vahe (ARM)

7 **ALIYEV, Murad** AZE

15 **ERRICHELLO, Davide** ITA

4 ALIYEV, Murad (AZE)

10 s1 / 01 s2 8:04

10 **ALIYEV, Murad (AZE)**

00 sH / 10 s1 3:06  
**Pool B - Winner**  
Vainqueur / Sieger

17 **ALIYEV, Murad (AZE)**

00 s3 / 10 s2 5:20

POOL C

2 **LOMITASHVILI, Daviti** GEO

10

5 LOMITASHVILI, D. (GEO)

6 **ORPHANOU, Daniel** FIN

14 **TARAN, Maxim** MDA

6 TARAN, Maxim (MDA)

00 / 11 s1 1:45

11 **LOMITASHVILI, D. (GEO)**

10 s1 / 00 s2 3:41  
**Pool C - Winner**  
Vainqueur / Sieger

**LOMITASHVILI, D. (GEO)**

00 s1 / 10 2:57

1.

18 **LOMITASHVILI, D. (GEO)**

10 / 00 0:21

POOL D

4 **SYNOLD, Raphael** FRA

12

7 SYNOLD, Raphael (FRA)

8 **SOPINEC, David** CZE

16 **RUBINSTEIN, Roy** ISR

8 RUBINSTEIN, Roy (ISR)

00 s1 / 01 s1 4:00

12 **SYNOLD, Raphael (FRA)**

10 / 00 sH 2:15  
**Pool D - Winner**  
Vainqueur / Sieger

Results		
Résultat / Platzierungen		
1.	LOMITASHVILI, Daviti	GEO
2.	ALIYEV, Murad	AZE
3.	AGHASYAN, Vahe	ARM
3.	RUBINSTEIN, Roy	ISR
5.	SYNOLD, Raphael	FRA
5.	TURKMAN, Tuncay	TUR
7.	LAMPREIA, Goncalo	POR
7.	TARAN, Maxim	MDA

Repechage / Trostrunde

[A1] \_\_\_\_\_

[A2] **LAMPREIA, Goncalo** POR

[B1] **ERRICHELLO, Davide** ITA

[B2] **AGHASYAN, Vahe** ARM

[C1] \_\_\_\_\_

[C2] **TARAN, Maxim** MDA

[D1] \_\_\_\_\_

[D2] **RUBINSTEIN, Roy** ISR

13 LAMPREIA, G. (POR)

19 **AGHASYAN, Vahe (ARM)**

00 / 10 0:00

14 **AGHASYAN, Vahe (ARM)**

00 s2 / 01 s1 4:15

21 **AGHASYAN, Vahe (ARM)**

10 s1 / 00 1:45

18 **SYNOLD, Raphael (FRA)**

3.

15 **TARAN, Maxim (MDA)**

20 **RUBINSTEIN, Roy (ISR)**

00 / 10 s2 3:25

16 **RUBINSTEIN, Roy (ISR)**

22 **RUBINSTEIN, Roy (ISR)**

01 s1 / 00 4:18

17 **TURKMAN, Tuncay (TUR)**

3.

**-60 kg**  
21 Judoka

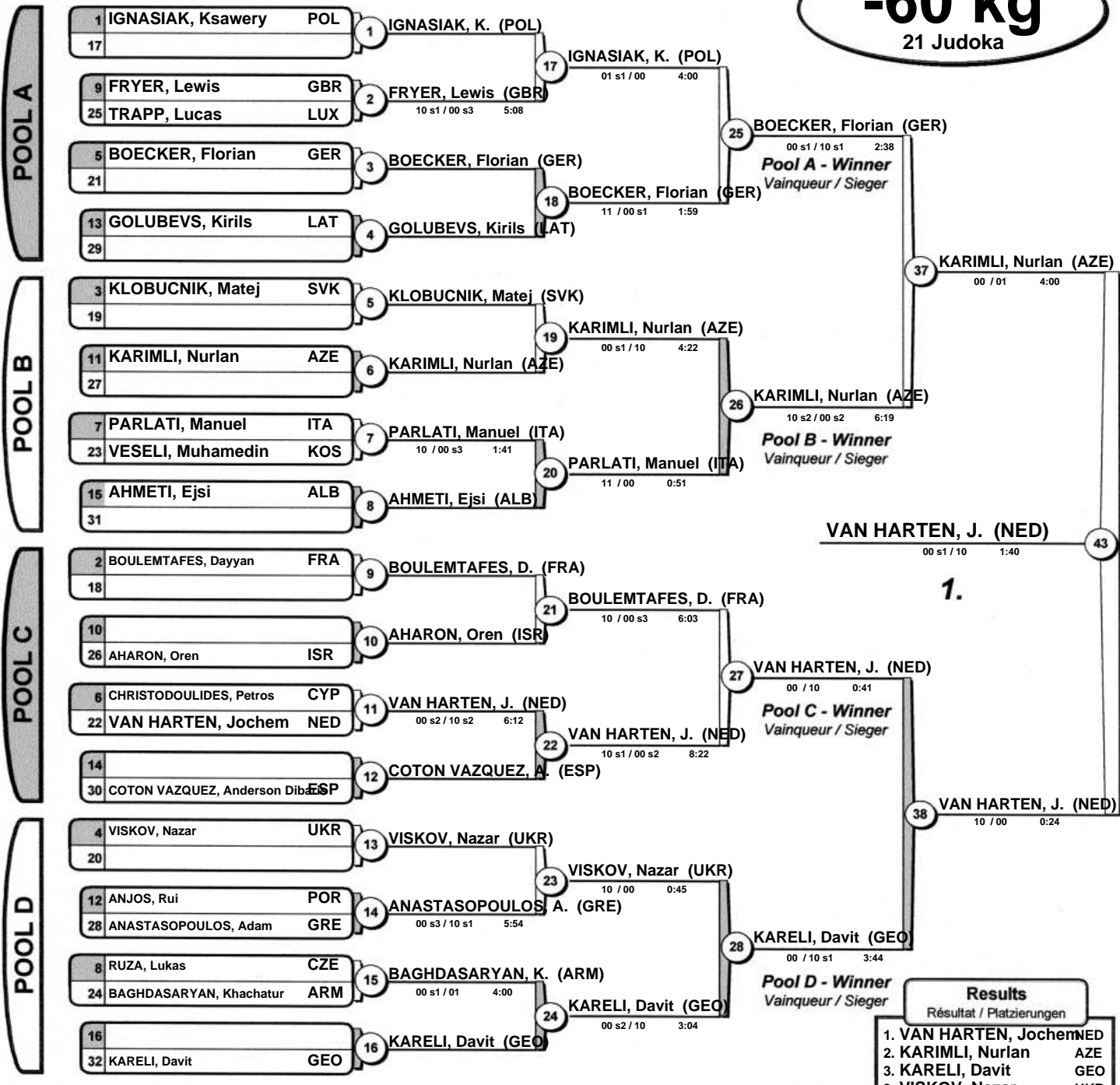

**Results**  
Résultat / Platzierungen

1.	VAN HARTEN, Jochem	NED
2.	KARIMLI, Nurlan	AZE
3.	KARELI, Davit	GEO
5.	PARLATI, Manuel	ITA
5.	BOECKER, Florian	GER
7.	IGNASIAK, Ksawery	POL
7.	COTON VAZQUEZ, Anderson Diba	ESP

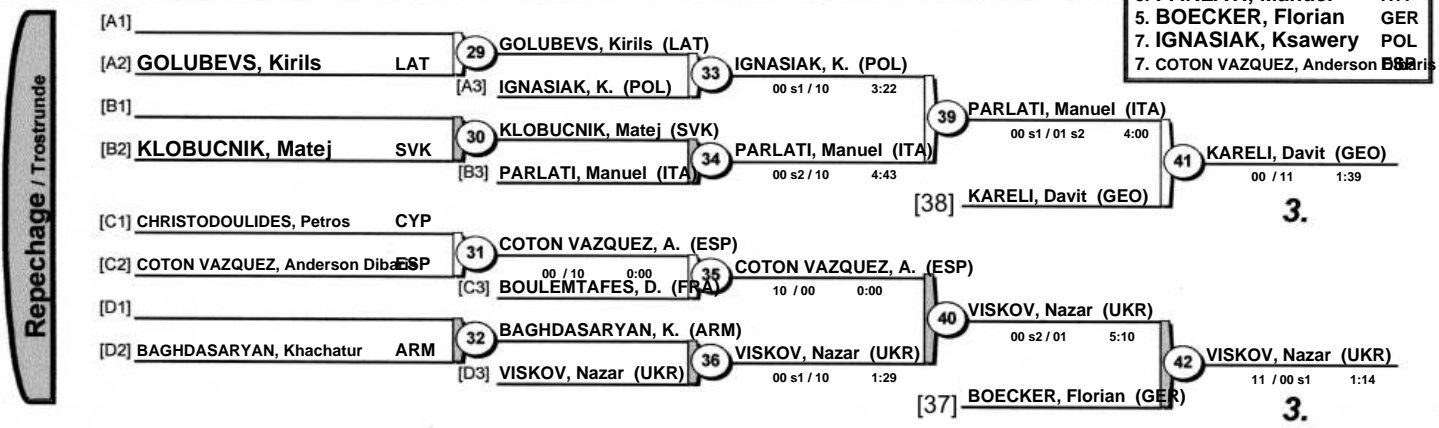



**-73 kg**  
29 Judoka

POOL A

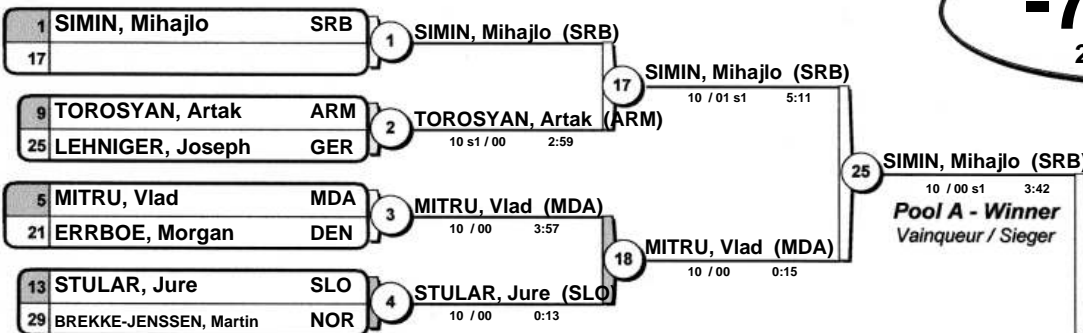

POOL B

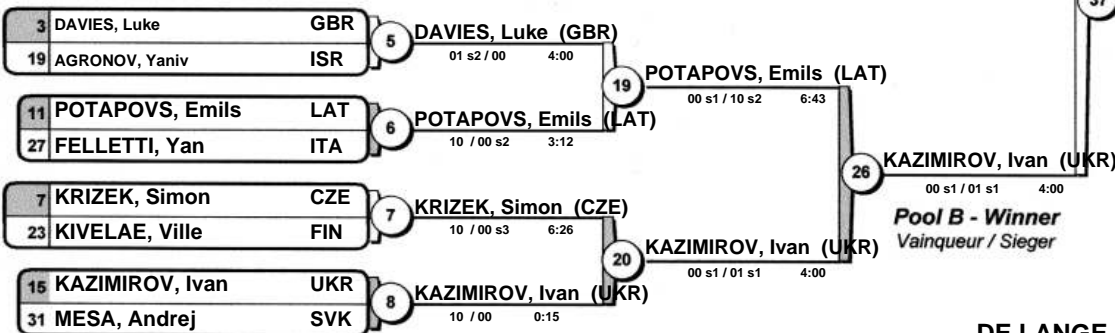

POOL C

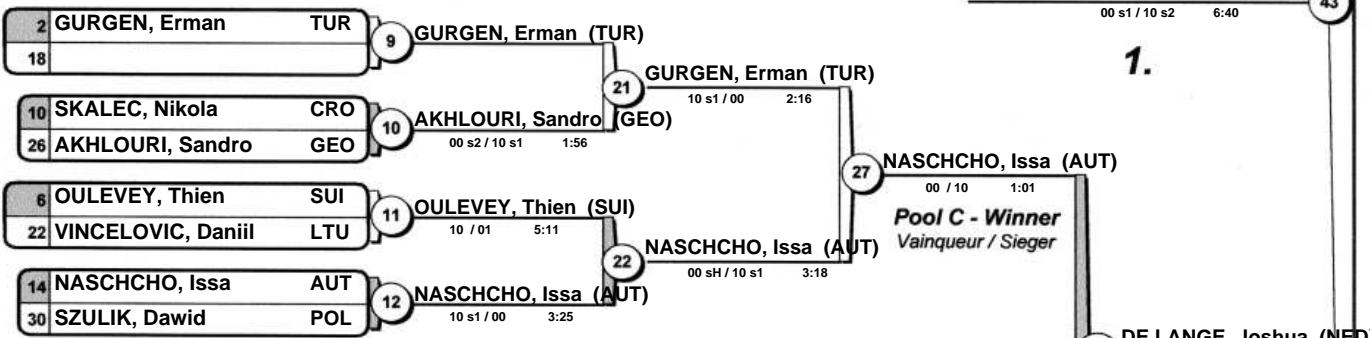

POOL D

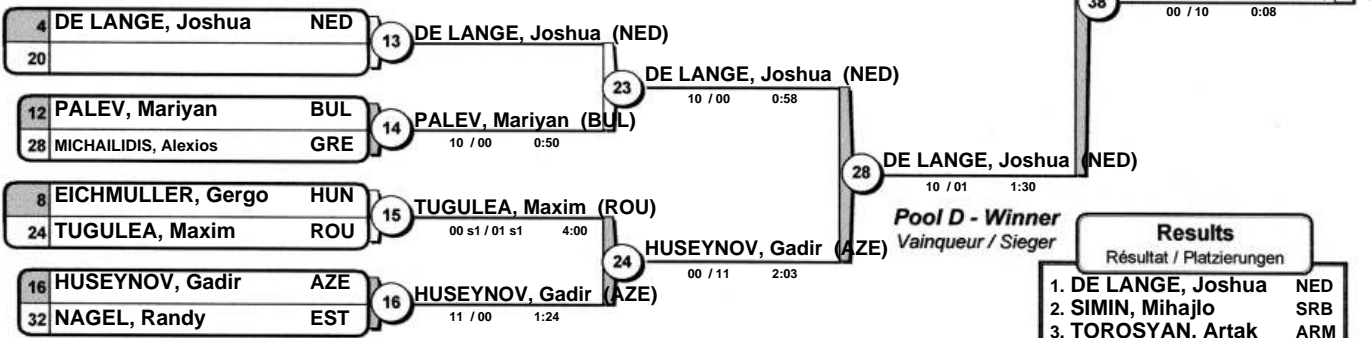

Results		
Résultat / Platzierungen		
1.	DE LANGE, Joshua	NED
2.	SIMIN, Mihajlo	SRB
3.	TOROSYAN, Artak	ARM
3.	KAZIMIROV, Ivan	UKR
5.	NASCHCHO, Issa	AUT
7.	PALEV, Mariyan	BUL
7.	KRIZEK, Simon	CZE
7.	GURGEN, Erman	TUR

Repechage / Trostrunde

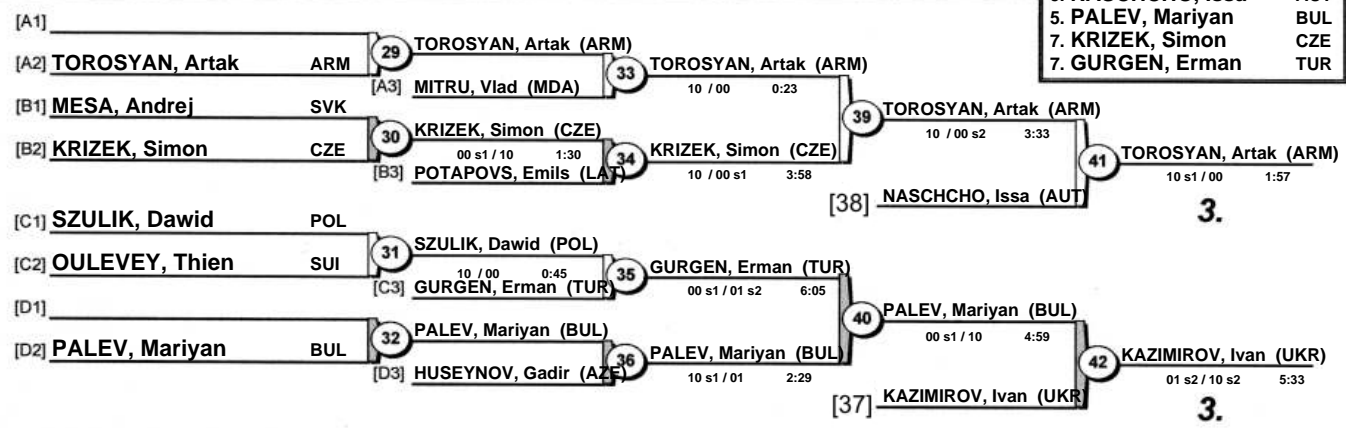



**-81 kg**  
31 Judoka

POOL A

1 ZAMANOV, Ismayil AZE	17 ZAMANOV, Ismayil (AZE)	10 s2 / 00 4:33
9 ZOROTOVIC, Luka CRO	25 ZAMANOV, Ismayil (AZE)	11 / 00 s3 3:43
25 NOOR, Rohil NOR	5 SIKOSEK, Gaber SLO	00 / 10 1:10
5 SIKOSEK, Gaber SLO	21 MARTINEZ COIN, Marcos ESP	01 s2 / 10 s1 5:27
21 MARTINEZ COIN, Marcos ESP	13 WASIKOWSKI, Michal POL	01 / 00 s2 4:11
13 WASIKOWSKI, Michal POL	29 MEDRE, Sebastian ROU	
29 MEDRE, Sebastian ROU	3 ZOROTOVIC, Luka CRO	
3 ZOROTOVIC, Luka CRO	2 MARTINEZ COIN, M. (ESP)	
2 MARTINEZ COIN, M. (ESP)	18 WASIKOWSKI, M. (POL)	
18 WASIKOWSKI, M. (POL)	4 WASIKOWSKI, M. (POL)	
4 WASIKOWSKI, M. (POL)		

**Pool A - Winner**  
Vainqueur / Sieger

POOL B

3 KARAPETYAN, Gor ARM	19 BOSVELD, Tobias NED	10 s1 / 00 2:06
19 BOSVELD, Tobias NED	11 GRIBINET, Ciprian MDA	10 / 00 1:34
11 GRIBINET, Ciprian MDA	27 KESHET HALEVI, Ori ISR	
27 KESHET HALEVI, Ori ISR	7 ZULYS, Algirdas LTU	00 / 11 1:29
7 ZULYS, Algirdas LTU	23 MALJEVIC, Vidak BIH	00 s1 / 10 s1 2:30
23 MALJEVIC, Vidak BIH	15 VALKOV, Hristo BUL	10 / 00 sH 0:54
15 VALKOV, Hristo BUL	31 ZUBOVIC, Stefan SRB	
31 ZUBOVIC, Stefan SRB	5 KARAPETYAN, Gor (ARM)	
5 KARAPETYAN, Gor (ARM)	19 KARAPETYAN, Gor (ARM)	
19 KARAPETYAN, Gor (ARM)	6 GRIBINET, C. (MDA)	
6 GRIBINET, C. (MDA)	20 VALKOV, Hristo (BUL)	
20 VALKOV, Hristo (BUL)		

**Pool B - Winner**  
Vainqueur / Sieger

POOL C

2 LOLADZE, Aleksandre GEO	18 KOMPE, Mertcan TUR	00 s1 / 11 s2 5:53
18 KOMPE, Mertcan TUR	10 KORCHEMLIUK, Stanislav UKR	10 / 00 1:00
10 KORCHEMLIUK, Stanislav UKR	26 TOMCZYK, Jakub ISL	
26 TOMCZYK, Jakub ISL	6 ZEILA, Matiss LAT	01 s1 / 00 4:00
6 ZEILA, Matiss LAT	22 MIKLOSVOLGYI, Daniel HUN	01 s2 / 00 4:41
22 MIKLOSVOLGYI, Daniel HUN	14 AUSTEN, Luke GBR	10 / 00 s2 1:54
14 AUSTEN, Luke GBR	30 PEREIRA, Francisco POR	
30 PEREIRA, Francisco POR	9 KOMPE, Mertcan (TUR)	
9 KOMPE, Mertcan (TUR)	21 KORCHEMLIUK, S. (UKR)	
21 KORCHEMLIUK, S. (UKR)	11 ZEILA, Matiss (LAT)	
11 ZEILA, Matiss (LAT)	22 ZEILA, Matiss (LAT)	
22 ZEILA, Matiss (LAT)		

**Pool C - Winner**  
Vainqueur / Sieger

POOL D

4 PUCHLY, Thomas FRA	20 PILT, Karl-Johannes EST	10 s1 / 00 s2 4:06
20 PILT, Karl-Johannes EST	12 OHNEISER, Lukas GER	01 s2 / 00 s1 4:00
12 OHNEISER, Lukas GER	28 KYVELIDIS, Panagiotis GRE	
28 KYVELIDIS, Panagiotis GRE	8 COPAK, JR., Gabriel SVK	10 / 00 2:55
8 COPAK, JR., Gabriel SVK	24 GLIGOROSKI, Hristijan MKD	11 s1 / 01 s1 4:16
24 GLIGOROSKI, Hristijan MKD	32 SANSONETTI, Francesco ITA	
32 SANSONETTI, Francesco ITA	13 PUCHLY, Thomas (FRA)	
13 PUCHLY, Thomas (FRA)	23 PUCHLY, Thomas (FRA)	
23 PUCHLY, Thomas (FRA)	14 OHNEISER, Lukas (GER)	
14 OHNEISER, Lukas (GER)	28 PUCHLY, Thomas (FRA)	
28 PUCHLY, Thomas (FRA)		

**Pool D - Winner**  
Vainqueur / Sieger

Results	
Résultat / Platzierungen	
1. KORCHEMLIUK, Stanislav	UKR
2. ZAMANOV, Ismayil	AZE
3. KARAPETYAN, Gor	ARM
3. ZEILA, Matiss	LAT
5. PUCHLY, Thomas	FRA
5. VALKOV, Hristo	BUL
7. ZOROTOVIC, Luka	CRO
7. PILT, Karl-Johannes	EST

Repechage / Trostrunde

[A1]	29 ZOROTOVIC, Luka (CRO)	33 ZOROTOVIC, Luka (CRO)	10 s2 / 00 s3 6:46
[A2] ZOROTOVIC, Luka CRO	[A3] WASIKOWSKI, M. (POL)	39 KARAPETYAN, Gor (ARM)	00 s3 / 10 s1 3:10
[B1] ZUBOVIC, Stefan SRB	30 ZUBOVIC, Stefan (SRB)	41 KARAPETYAN, Gor (ARM)	10 s1 / 00 s3 4:35
[B2] MALJEVIC, Vidak BIH	34 KARAPETYAN, Gor (ARM)	[38] PUCHLY, Thomas (FRA)	
[B3] KARAPETYAN, Gor (ARM)			
[C1] TOMCZYK, Jakub ISL	31 KOMPE, Mertcan (TUR)	35 ZEILA, Matiss (LAT)	00 / 10 1:09
[C2] KOMPE, Mertcan TUR	[C3] ZEILA, Matiss (LAT)	40 ZEILA, Matiss (LAT)	10 / 00 0:45
[D1] PILT, Karl-Johannes EST	32 PILT, K. (EST)	42 ZEILA, Matiss (LAT)	10 s1 / 00 4:00
[D2] OHNEISER, Lukas GER	[D3] COPAK, JR., G. (SVK)	[37] VALKOV, Hristo (BUL)	

**-90 kg**  
24 Judoka

POOL A

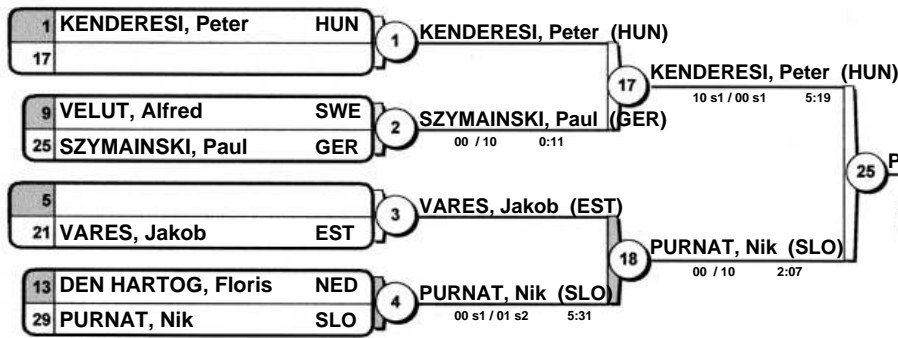

POOL B

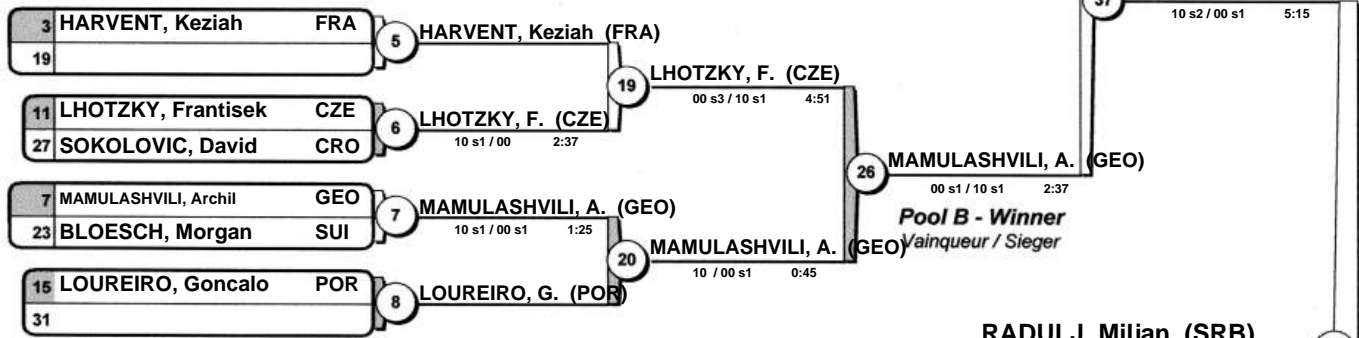

POOL C

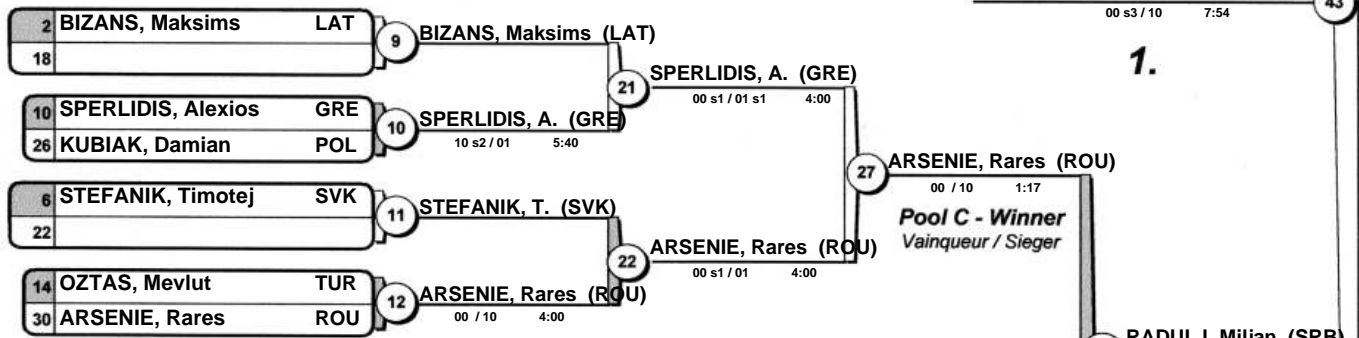

POOL D

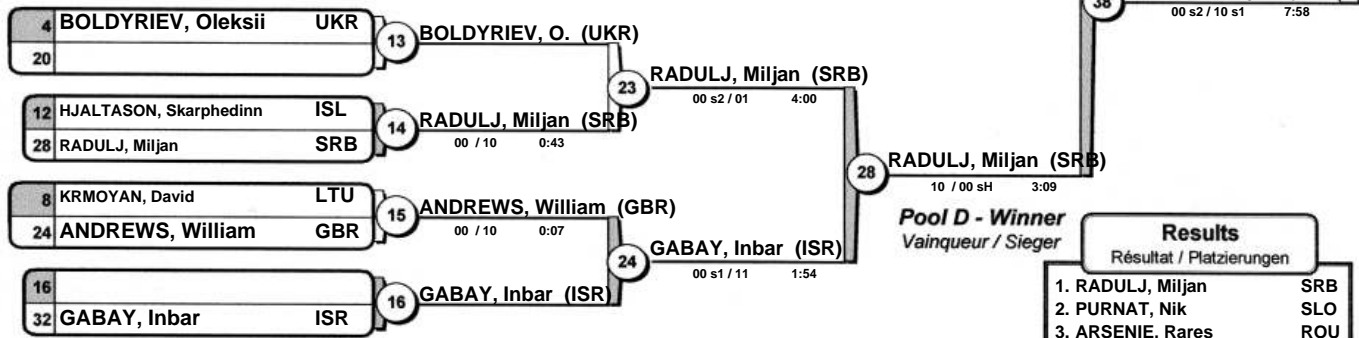

Results	
Résultat / Platzierungen	
1. RADULJ, Miljan	SRB
2. PURNAT, Nik	SLO
3. ARSENIE, Rares	ROU
3. MAMULASHVILI, Archil	GEO
5. LHOTZKY, Frantisek	CZE
5. GABAY, Inbar	ISR
7. KENDERESI, Peter	HUN
7. SPERLIDIS, Alexios	GRE

Repechage / Trostrunde

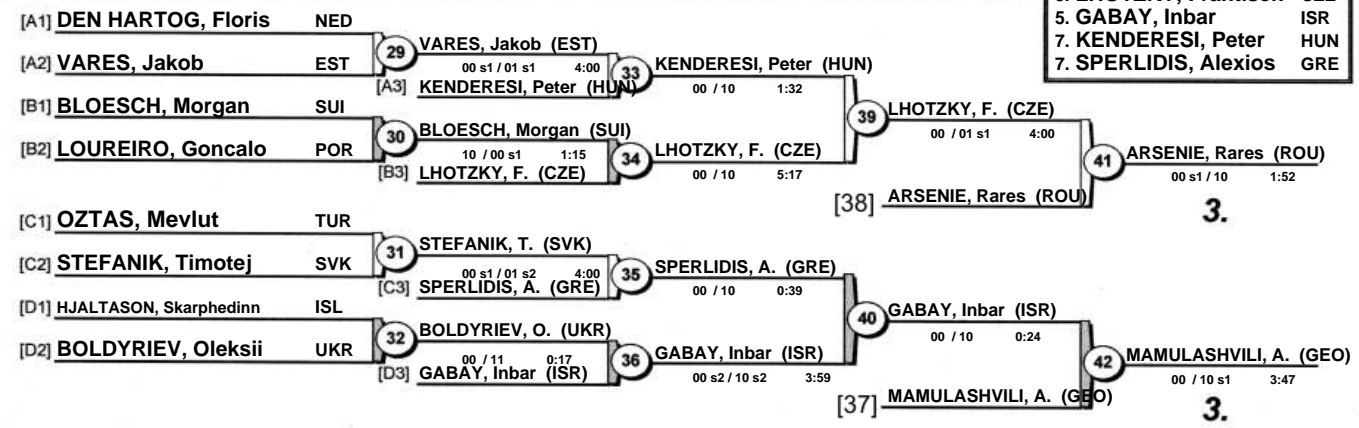

**-100 kg**  
8 Judoka

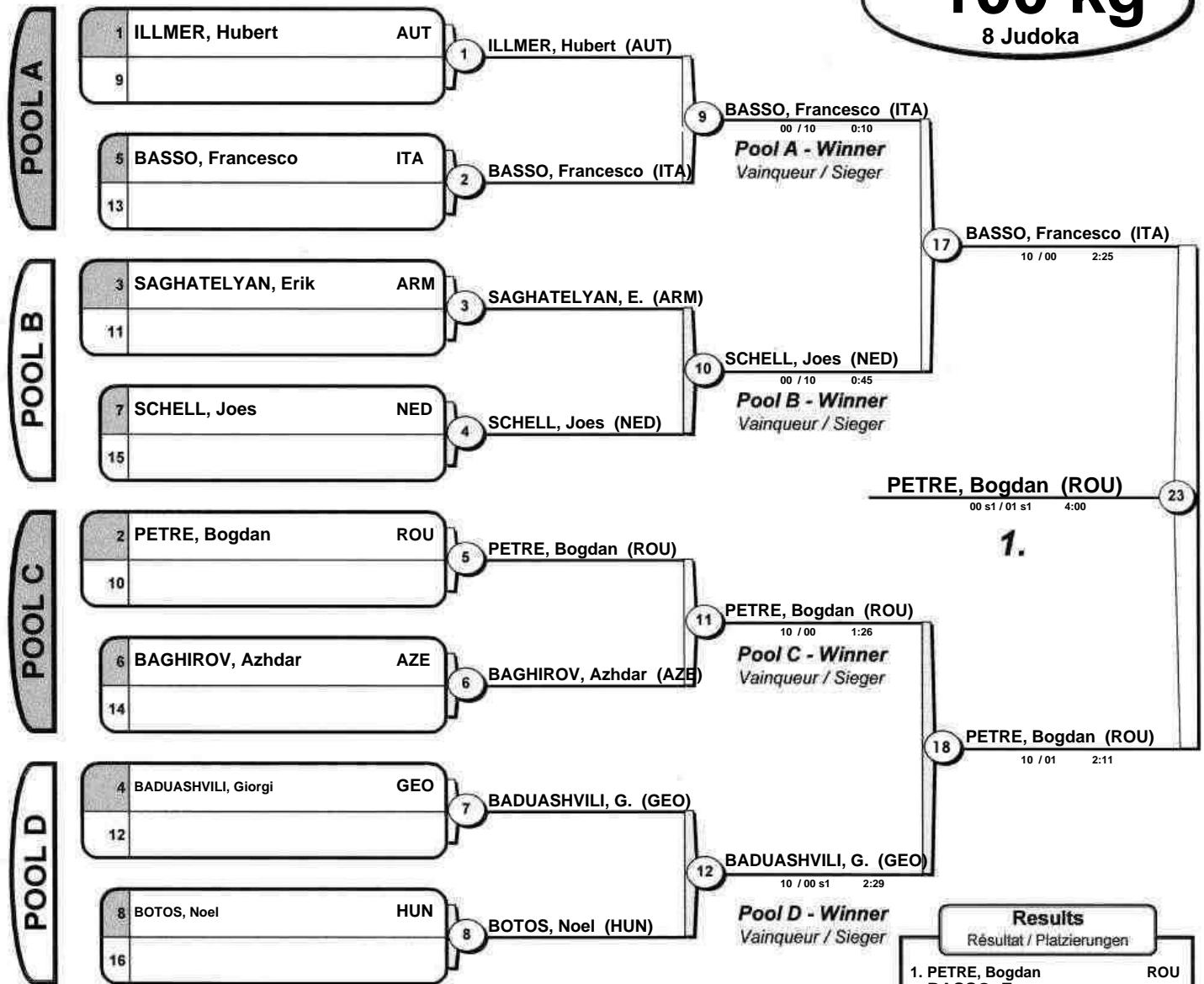

Results	
Résultat / Platzierungen	
1.	PETRE, Bogdan ROU
2.	BASSO, Francesco ITA
3.	BADUASHVILI, Giorgi GEO
3.	SCHELL, Joes NED
5.	SAGHATELYAN, Erik ARM
7.	ILLMER, Hubert AUT
7.	BOTOS, Noel HUN

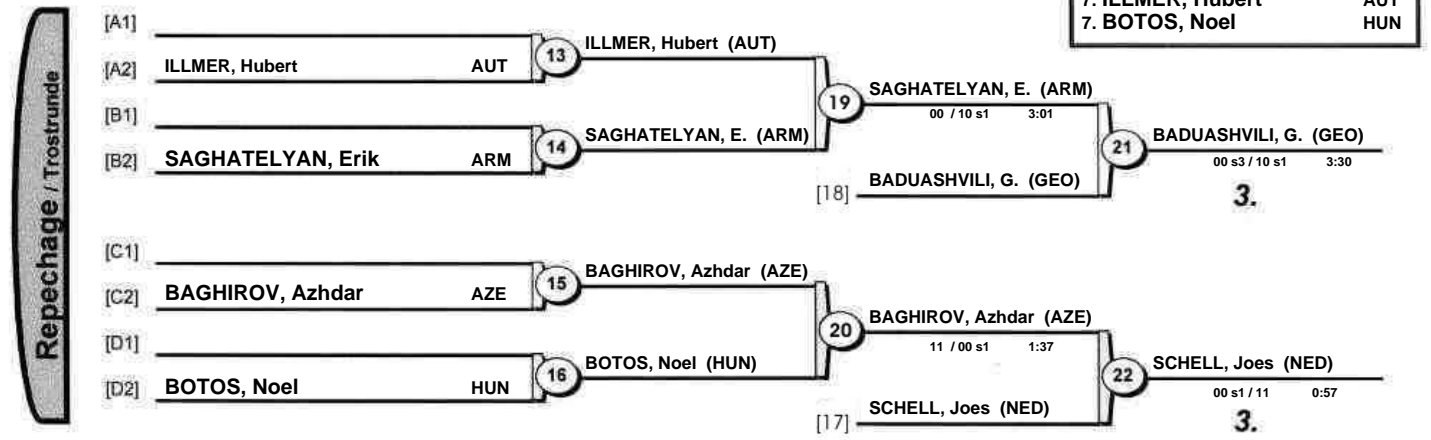

# +100 kg

18 Judoka

POOL A

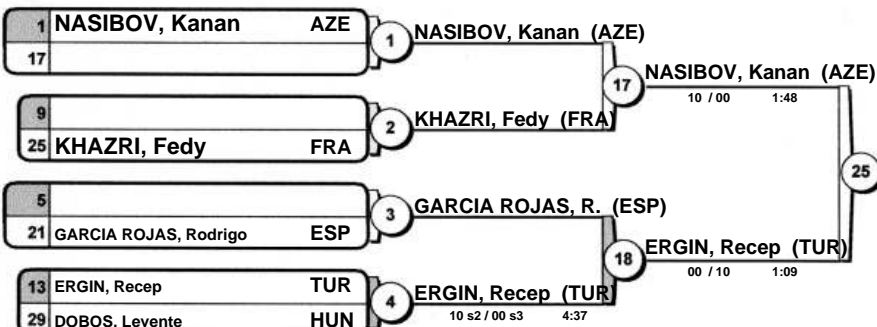

**Pool A - Winner**  
Vainqueur / Sieger

POOL B

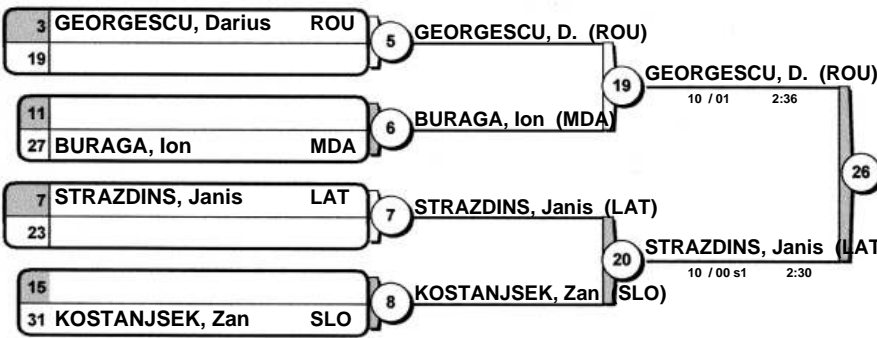

**Pool B - Winner**  
Vainqueur / Sieger

POOL C

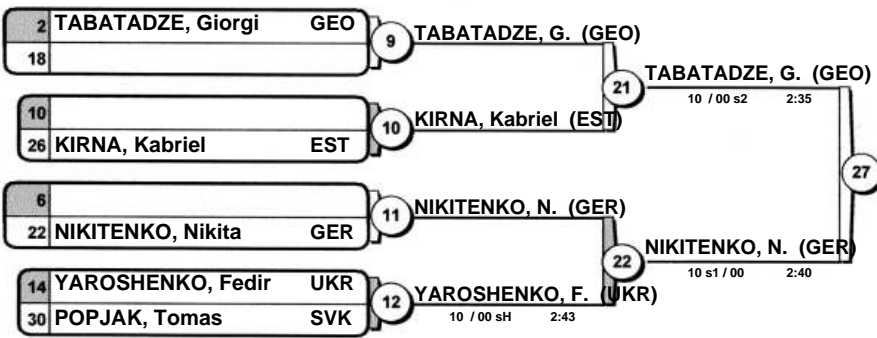

**Pool C - Winner**  
Vainqueur / Sieger

POOL D

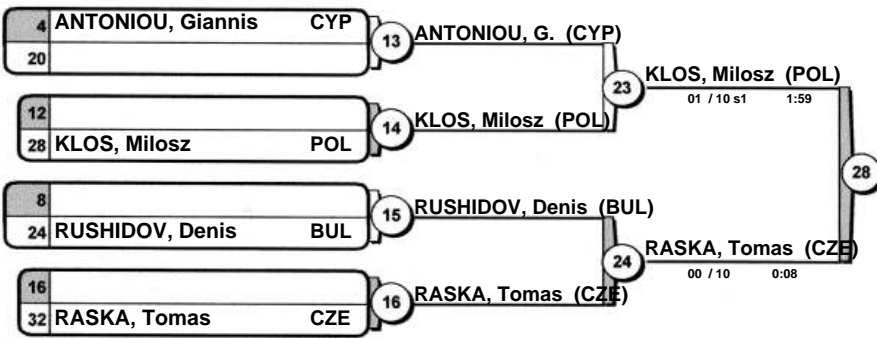

**Pool D - Winner**  
Vainqueur / Sieger

TABATADZE, G. (GEO)

1.

Results		
Résultat / Platzierungen		
1.	TABATADZE, Giorgi	GEO
2.	ERGIN, Recep	TUR
3.	NASIBOV, Kanan	AZE
4.	ANTONIOU, Giannis	CYP
5.	KLOS, Milosz	POL
6.	GEORGESCU, Darius	ROU
7.	STRAZDINS, Janis	LAT
8.	NIKITENKO, Nikita	GER

Repechage / Trostrunde

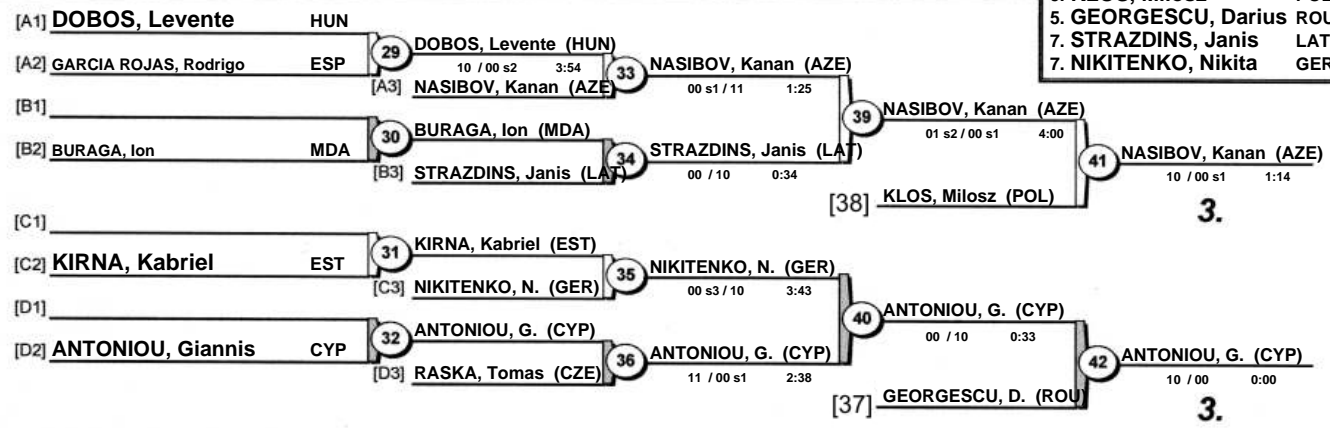

3.

3.

**-44 kg**  
8 Judoka

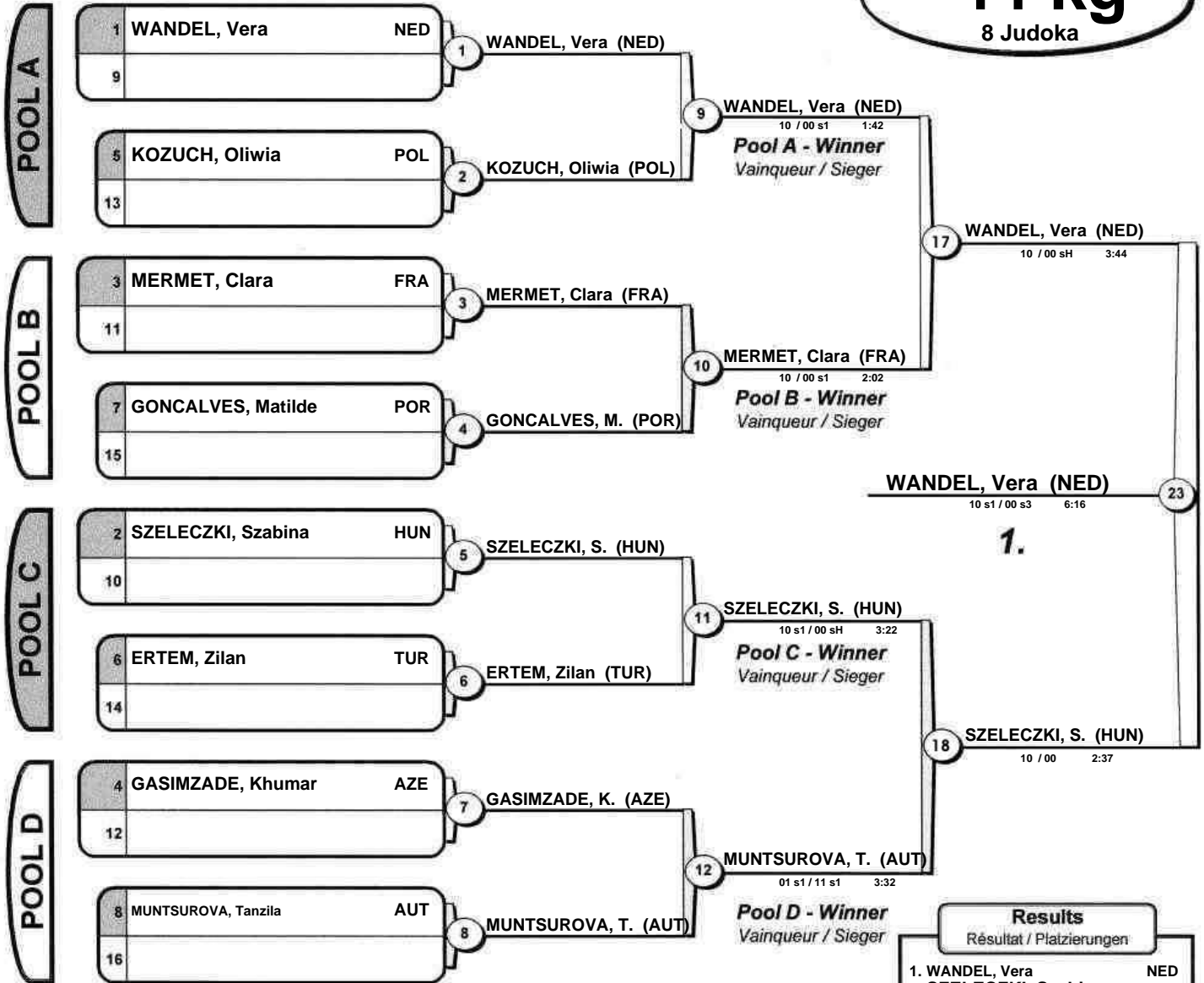

Results	
Résultat / Platzierungen	
1. WANEL, Vera	NED
2. SZELECZKI, Szabina	HUN
3. MUNTSUROVA, Tanzila	AUT
3. MERMET, Clara	FRA
5. KOZUCH, Oliwia	POL
7. GASIMZADE, Khumar	AZE
7. ERTEM, Zilan	TUR

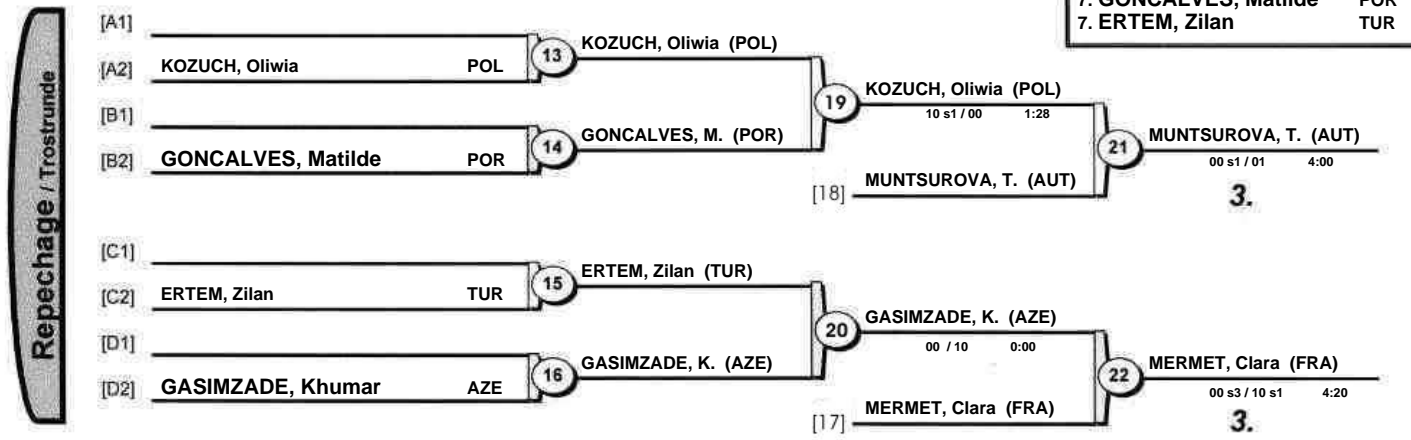

**-48 kg**  
12 Judoka

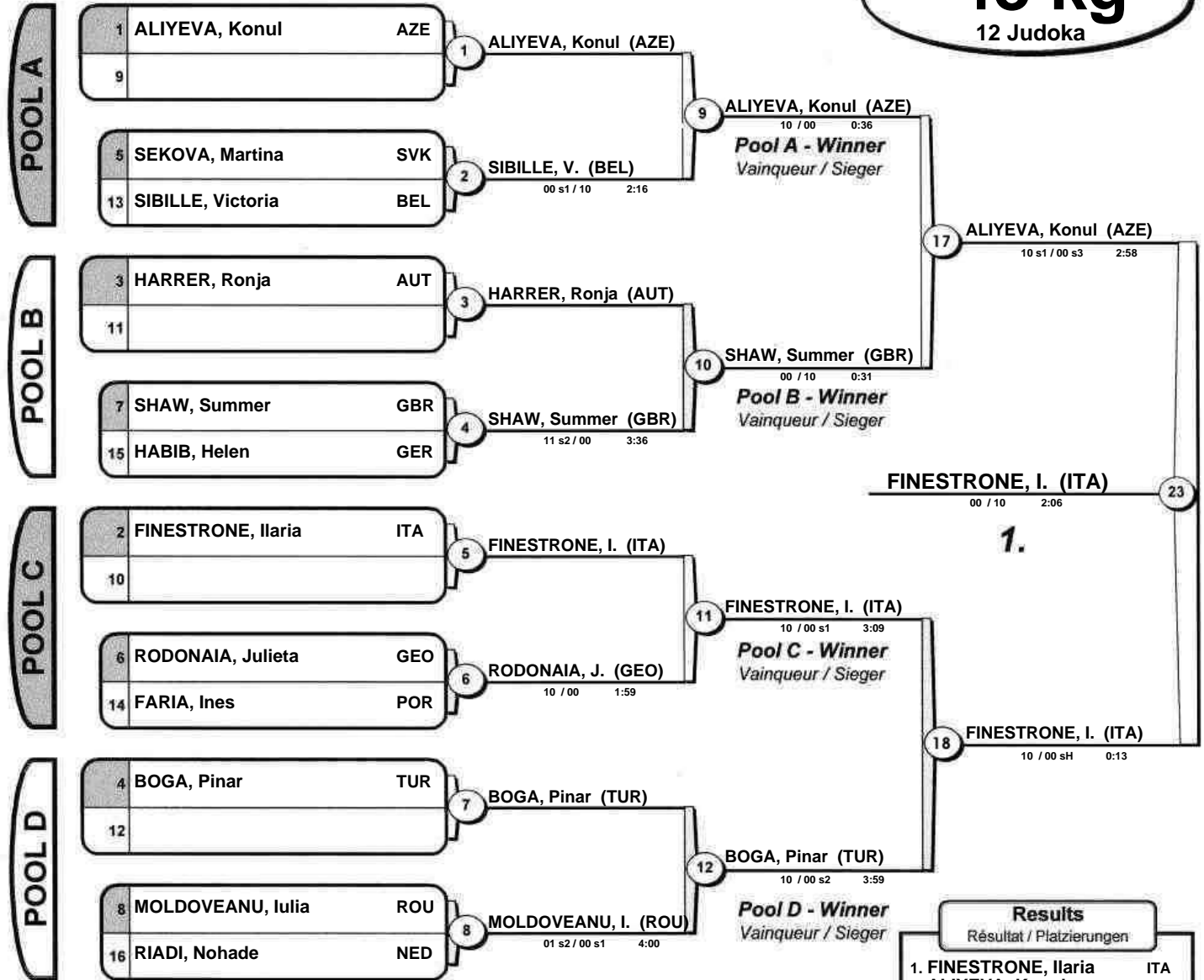

Results	
Résultat / Platzierungen	
1.	FINESTRONE, Ilaria (ITA)
2.	ALIYEVA, Konul (AZE)
3.	HABIB, Helen (GER)
3.	SHAW, Summer (GBR)
5.	BOGA, Pinar (TUR)
5.	RODONAIA, Julieta (GEO)
7.	SIBILLE, Victoria (BEL)
7.	MOLDOVEANU, Iulia (ROU)

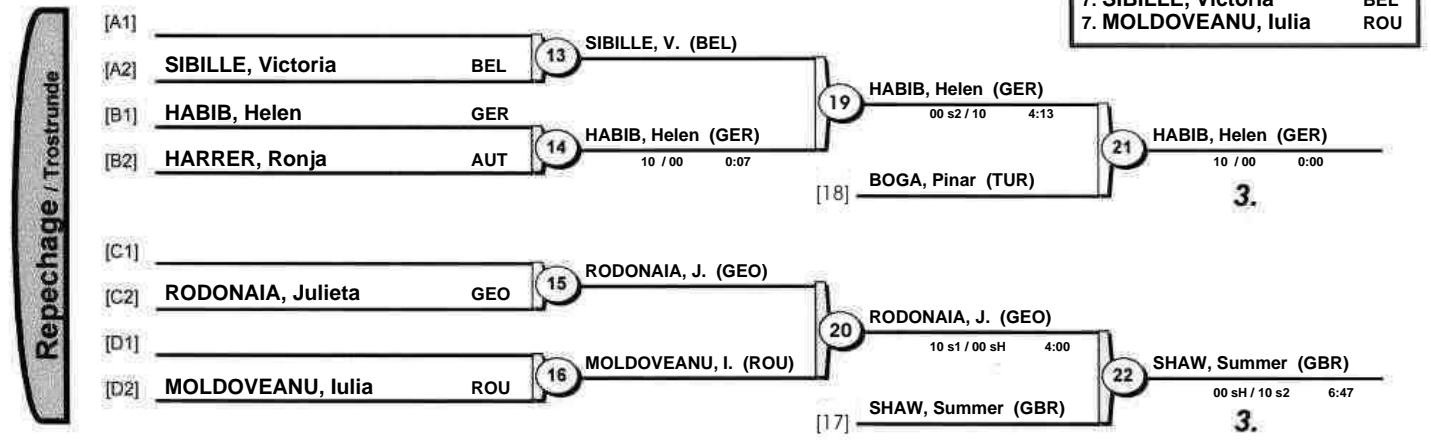

**-52 kg**  
24 Judoka

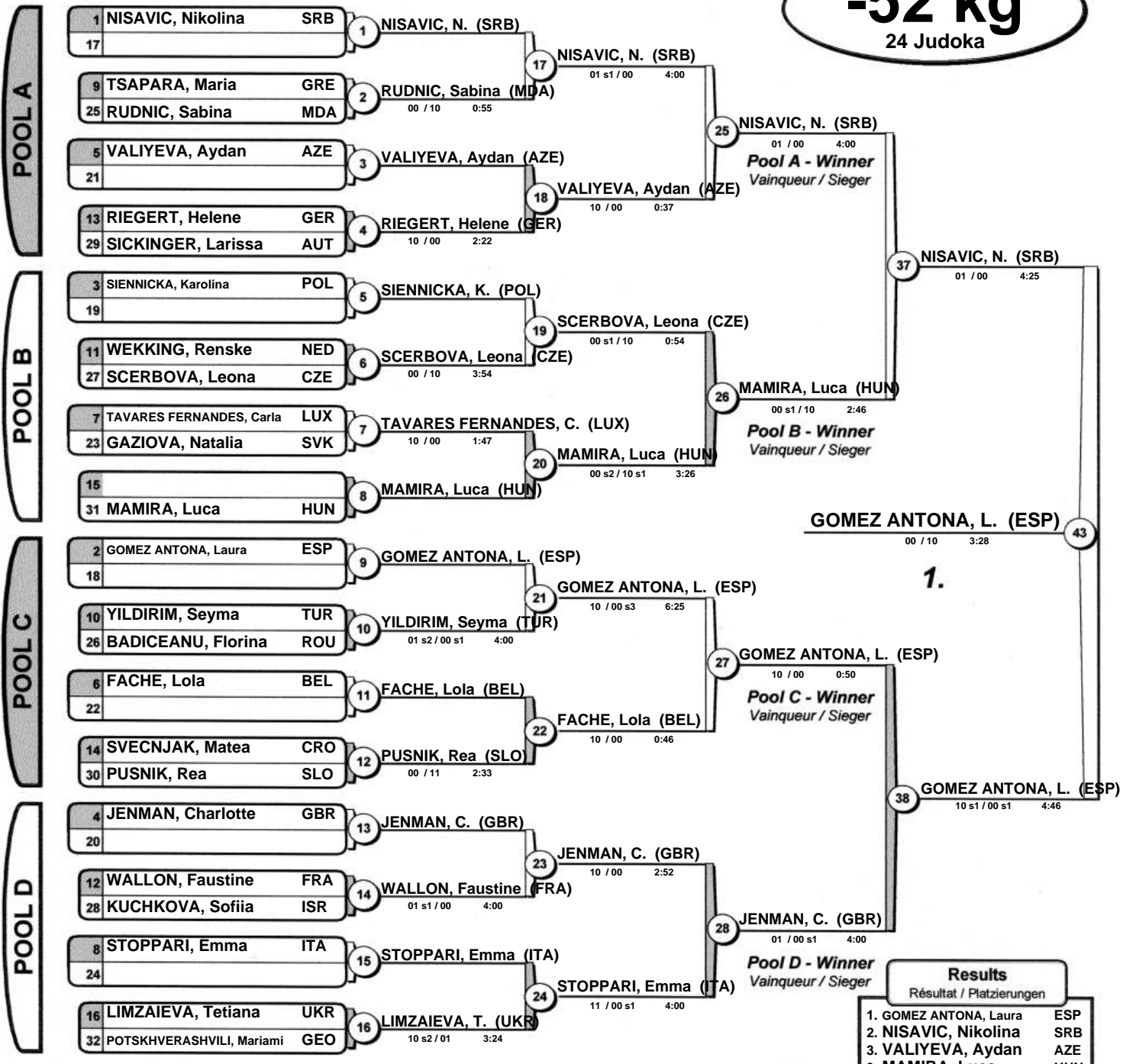

Results		
Résultat / Platzierungen		
1.	GOMEZ ANTONA, Laura	ESP
2.	NISAVIC, Nikolina	SRB
3.	VALIYEVA, Aydan	AZE
3.	MAMIRA, Luca	HUN
5.	JENMAN, Charlotte	GBR
5.	WALLON, Faustine	FRA
7.	SCERBOVA, Leona	CZE
7.	YILDIRIM, Seyma	TUR

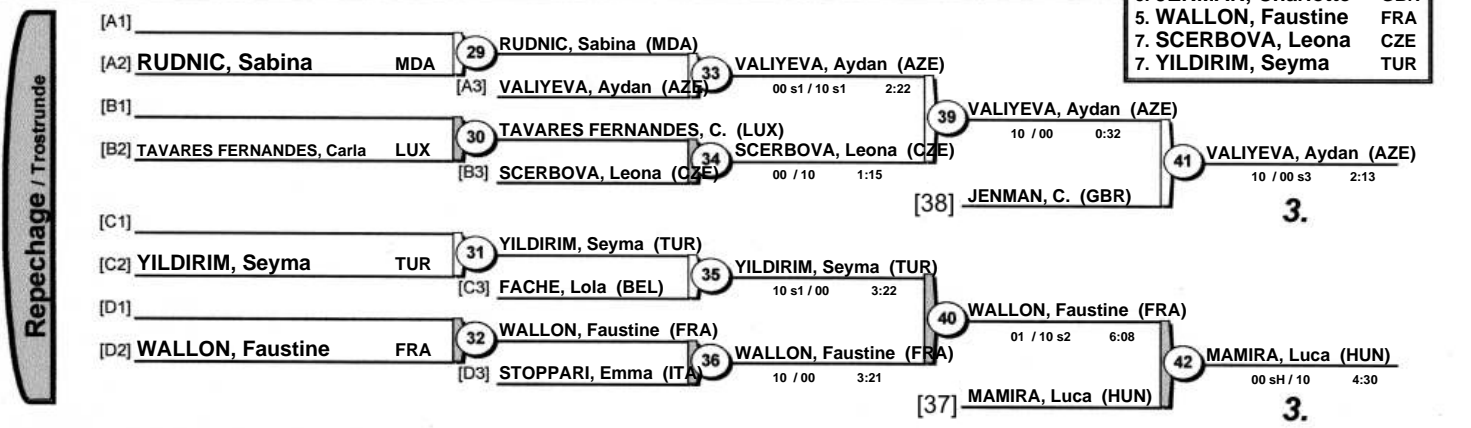







-70 kg 21 Judoka

POOL A

Pool A bracket: 1 KOREN, Nika (SLO) vs 17 KOREN, Nika (SLO); 9 PAJIC, Sofija (BIH) vs 25 VIDENEIEVA, Alisa (UKR); 5 BUDDENKOTTE, Eva Ronja (GER) vs 21 BUDDENKOTTE, E. (GER); 13 vs 29 TUGUTSCHII, Adelina (MDA); 13 vs 29 TUGUTSCHII, A. (MDA)

Pool A continuation: 25 KOREN, Nika (SLO) vs 18 BUDDENKOTTE, E. (GER); 17 KOREN, Nika (SLO) vs 18 BUDDENKOTTE, E. (GER); 17 KOREN, Nika (SLO) vs 37 NILSSON, Ingrid (SWE)

POOL B

Pool B bracket: 3 NILSSON, Ingrid (SWE) vs 19 NILSSON, Ingrid (SWE); 11 BALOGH, Hanna (ROU) vs 27 BALOGH, Hanna (ROU); 7 KOWALEWSKA, Aleksandra (POL) vs 23 KOWALEWSKA, A. (POL); 15 NARVA, Anni-Olivia (FIN) vs 31 BAYSUG, Ecem (TUR); 15 NARVA, Anni-Olivia (FIN) vs 31 BAYSUG, Ecem (TUR)

Pool B continuation: 19 NILSSON, Ingrid (SWE) vs 20 BAYSUG, Ecem (TUR); 11 BALOGH, Hanna (ROU) vs 20 BAYSUG, Ecem (TUR); 19 NILSSON, Ingrid (SWE) vs 26 NILSSON, Ingrid (SWE); 26 NILSSON, Ingrid (SWE) vs 43 NILSSON, Ingrid (SWE)

POOL C

Pool C bracket: 2 DENG, Elena (AUT) vs 18 DENG, Elena (AUT); 10 DEPRI, Ilona (FRA) vs 26 PLOEGER, Annemarijne (NED); 6 BAR OR, Gaya (ISR) vs 22 BAR OR, Gaya (ISR); 14 VYCPALKOVA, Anna (CZE) vs 30 VYCPALKOVA, Anna (CZE)

Pool C continuation: 21 DENG, Elena (AUT) vs 27 DENG, Elena (AUT); 10 DEPRI, Ilona (FRA) vs 27 DENG, Elena (AUT); 21 DENG, Elena (AUT) vs 38 DENG, Elena (AUT); 27 DENG, Elena (AUT) vs 38 DENG, Elena (AUT)

POOL D

Pool D bracket: 4 FOHO, April Lynn (SUI) vs 20 FOHO, A. (SUI); 12 USANOVA, Valeria (EST) vs 28 GIUSTI, Eleonora (ITA); 8 JURKEVICA, Kristiana (LAT) vs 24 JURKEVICA, K. (LAT); 16 SKVARENINOVA, Natalia (SVK) vs 32 GULBANI, Nino (GEO); 12 USANOVA, Valeria (EST) vs 28 GIUSTI, Eleonora (ITA)

Pool D continuation: 23 GIUSTI, Eleonora (ITA) vs 28 GULBANI, Nino (GEO); 12 USANOVA, Valeria (EST) vs 28 GULBANI, Nino (GEO); 23 GIUSTI, Eleonora (ITA) vs 28 GULBANI, Nino (GEO); 28 GULBANI, Nino (GEO) vs 38 DENG, Elena (AUT); 28 GULBANI, Nino (GEO) vs 43 NILSSON, Ingrid (SWE)

Results table with 7 columns: Rank, Name, Country. Lists winners: 1. NILSSON, Ingrid (SWE), 2. DENG, Elena (AUT), 3. GULBANI, Nino (GEO), 3. KOREN, Nika (SLO), 5. BALOGH, Hanna (ROU), 7. BUDDENKOTTE, Eva Ronja (GER), 7. GIUSTI, Eleonora (ITA)

Repechage / Trostrunde

Repechage bracket: [A1] vs [A2] VIDENEIEVA, Alisa (UKR) vs [A3] BUDDENKOTTE, E. (GER); [B1] vs [B2] BALOGH, Hanna (ROU) vs [B3] BAYSUG, Ecem (TUR); [C1] vs [C2] DEPRI, Ilona (FRA) vs [C3] BAR OR, Gaya (ISR); [D1] SKVARENINOVA, Natalia (SVK) vs [D2] JURKEVICA, Kristiana (LAT) vs [D3] GIUSTI, Eleonora (ITA)

Repechage continuation: [A2] VIDENEIEVA, Alisa (UKR) vs [A3] BUDDENKOTTE, E. (GER); [B2] BALOGH, Hanna (ROU) vs [B3] BAYSUG, Ecem (TUR); [C2] DEPRI, Ilona (FRA) vs [C3] BAR OR, Gaya (ISR); [D2] JURKEVICA, Kristiana (LAT) vs [D3] GIUSTI, Eleonora (ITA); [39] BALOGH, Hanna (ROU) vs [41] GULBANI, Nino (GEO); [38] GULBANI, Nino (GEO) vs [41] GULBANI, Nino (GEO); [40] BAR OR, Gaya (ISR) vs [42] KOREN, Nika (SLO); [37] KOREN, Nika (SLO) vs [42] KOREN, Nika (SLO)

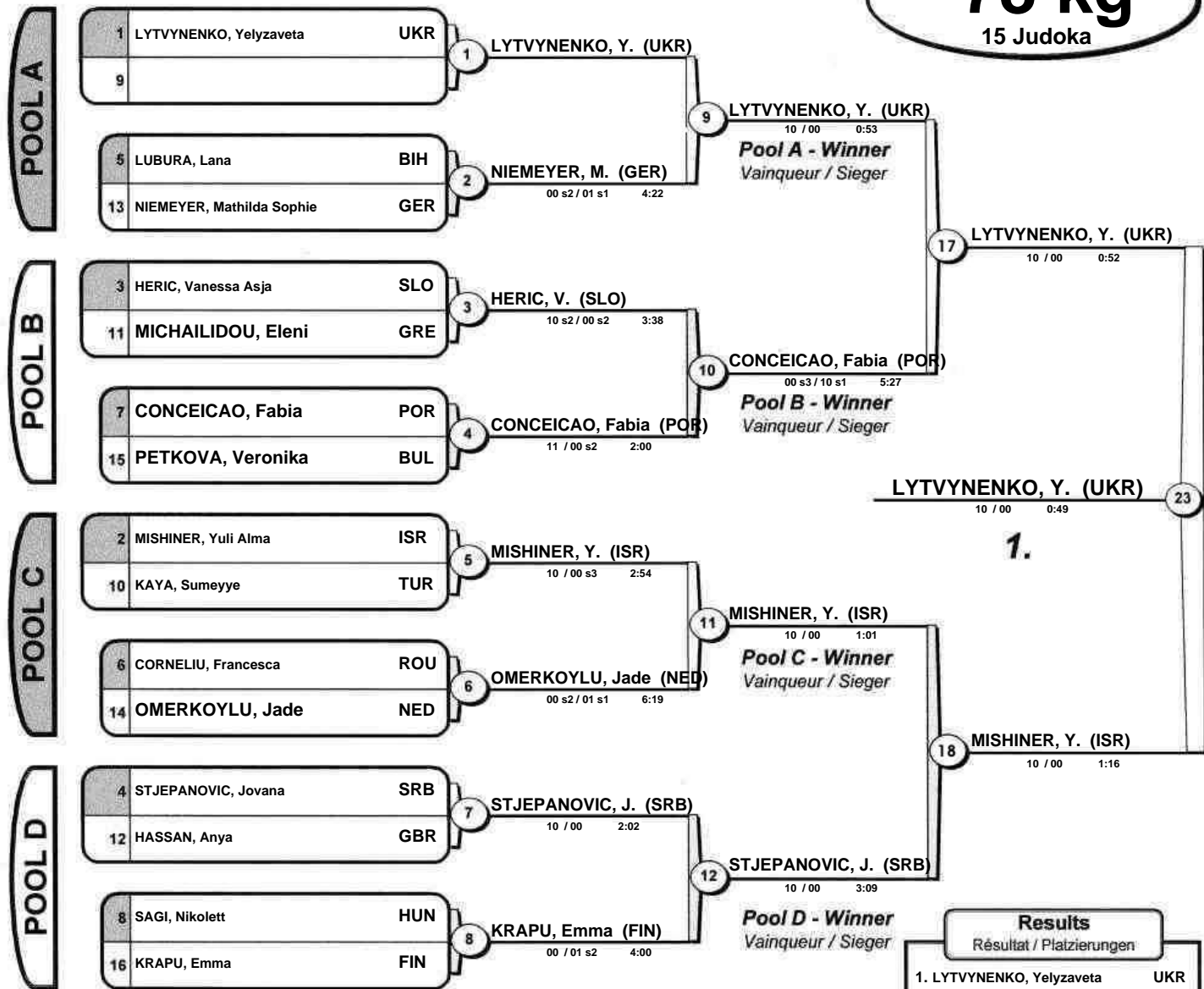

Results	
Résultat / Platzierungen	
1.	LYTVYENKO, Yelyzaveta (UKR)
2.	MISHINER, Yuli Alma (ISR)
3.	NIEMEYER, Mathilda Sophie (GER)
3.	CONCEICAO, Fabia (POR)
5.	STJEPANOVIC, Jovana (SRB)
5.	KAYA, Sumeyye (TUR)
7.	HERIC, Vanessa Asja (SLO)
7.	KRAPU, Emma (FIN)

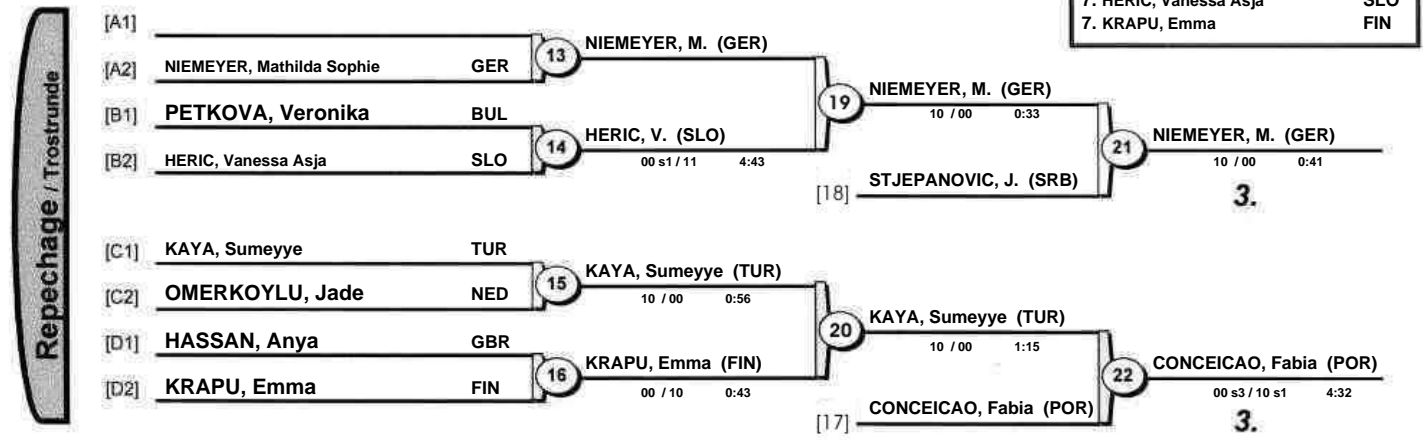

	1	3	5	Wins	Score
1 DE PAOLI, Morgana ITA		0	1	1	0
3 LANG, Bintibe FRA	1		1	2	0
5 SULEYMANOVA, Nigar AZE	0	0		0	0

	2	4	Wins	Scores
2 SEMCHENKO, Diana UKR		1		(0)
4 VRANJES, Marcelina CRO	0			(0)

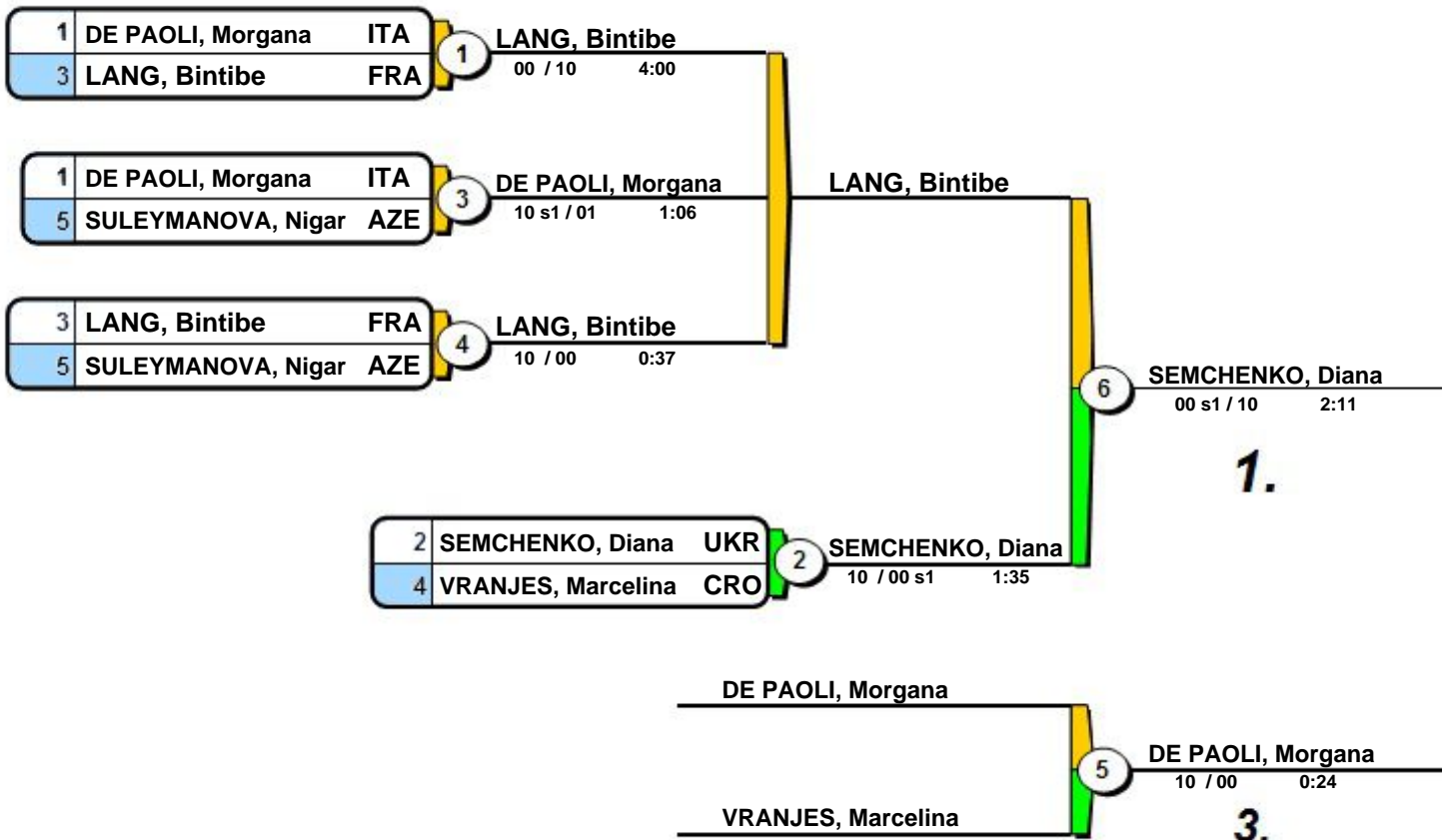

## Final Results

1. SEMCHENKO, Diana UKR
2. LANG, Bintibe FRA
3. DE PAOLI, Morgana ITA