

**-55 kg**

11 Judoka

POOL A

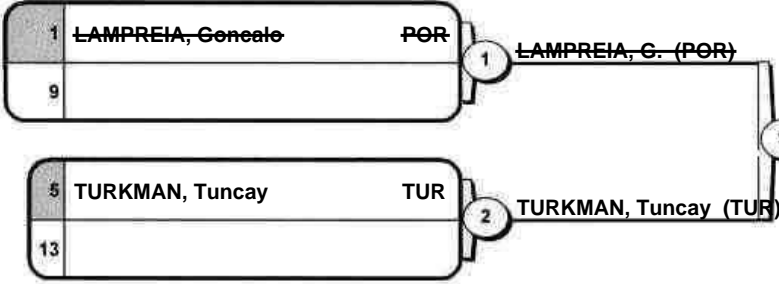

9 TURKMAN, Tuncay (TUR)  
00 / 10 0:00  
**Pool A - Winner**  
Vainqueur / Sieger

POOL B

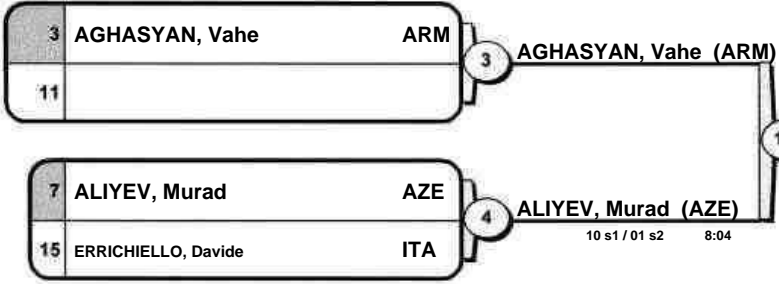

10 ALIYEV, Murad (AZE)  
00 sH / 10 s1 3:06  
**Pool B - Winner**  
Vainqueur / Sieger

POOL C

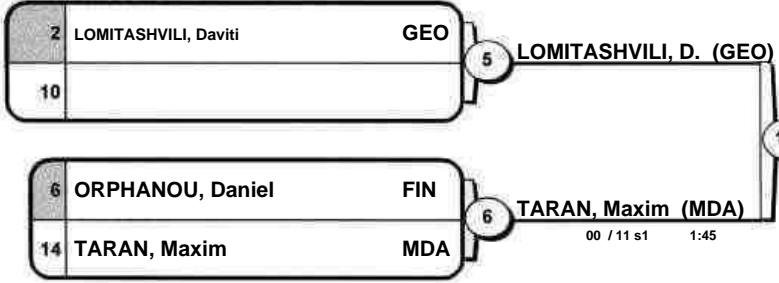

11 LOMITASHVILI, D. (GEO)  
10 s1 / 00 s2 3:41  
**Pool C - Winner**  
Vainqueur / Sieger

POOL D

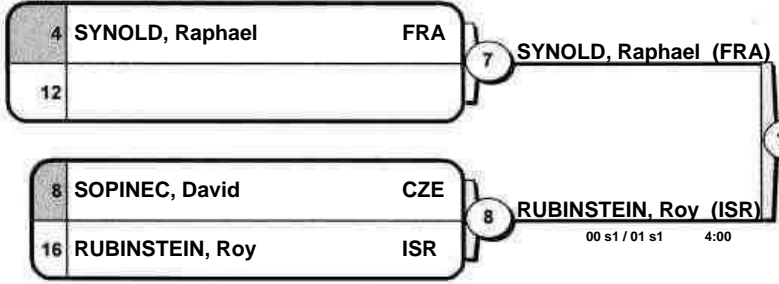

12 SYNOLD, Raphael (FRA)  
10 / 00 sH 2:15  
**Pool D - Winner**  
Vainqueur / Sieger

17 ALIYEV, Murad (AZE) vs 23 LOMITASHVILI, D. (GEO)  
00 s3 / 10 s2 5:20

1. LOMITASHVILI, D. (GEO)  
00 s1 / 10 2:57

18 LOMITASHVILI, D. (GEO)  
10 / 00 0:21

Results		
Résultat / Platzierungen		
1.	LOMITASHVILI, Daviti	GEO
2.	ALIYEV, Murad	AZE
3.	AGHASYAN, Vahe	ARM
3.	RUBINSTEIN, Roy	ISR
5.	SYNOLD, Raphael	FRA
5.	TURKMAN, Tuncay	TUR
7.	LAMPREIA, Genealo	POR
7.	TARAN, Maxim	MDA

Repechage / Trostrunde

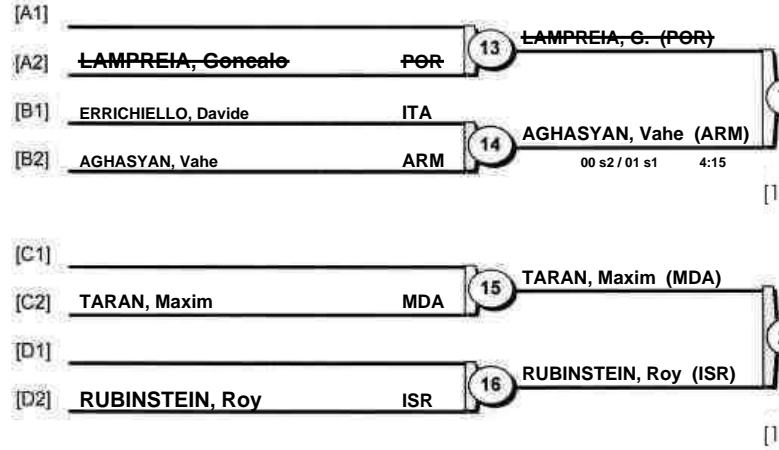

3. AGHASYAN, Vahe (ARM)

3. RUBINSTEIN, Roy (ISR)











**-81 kg**  
31 Judoka

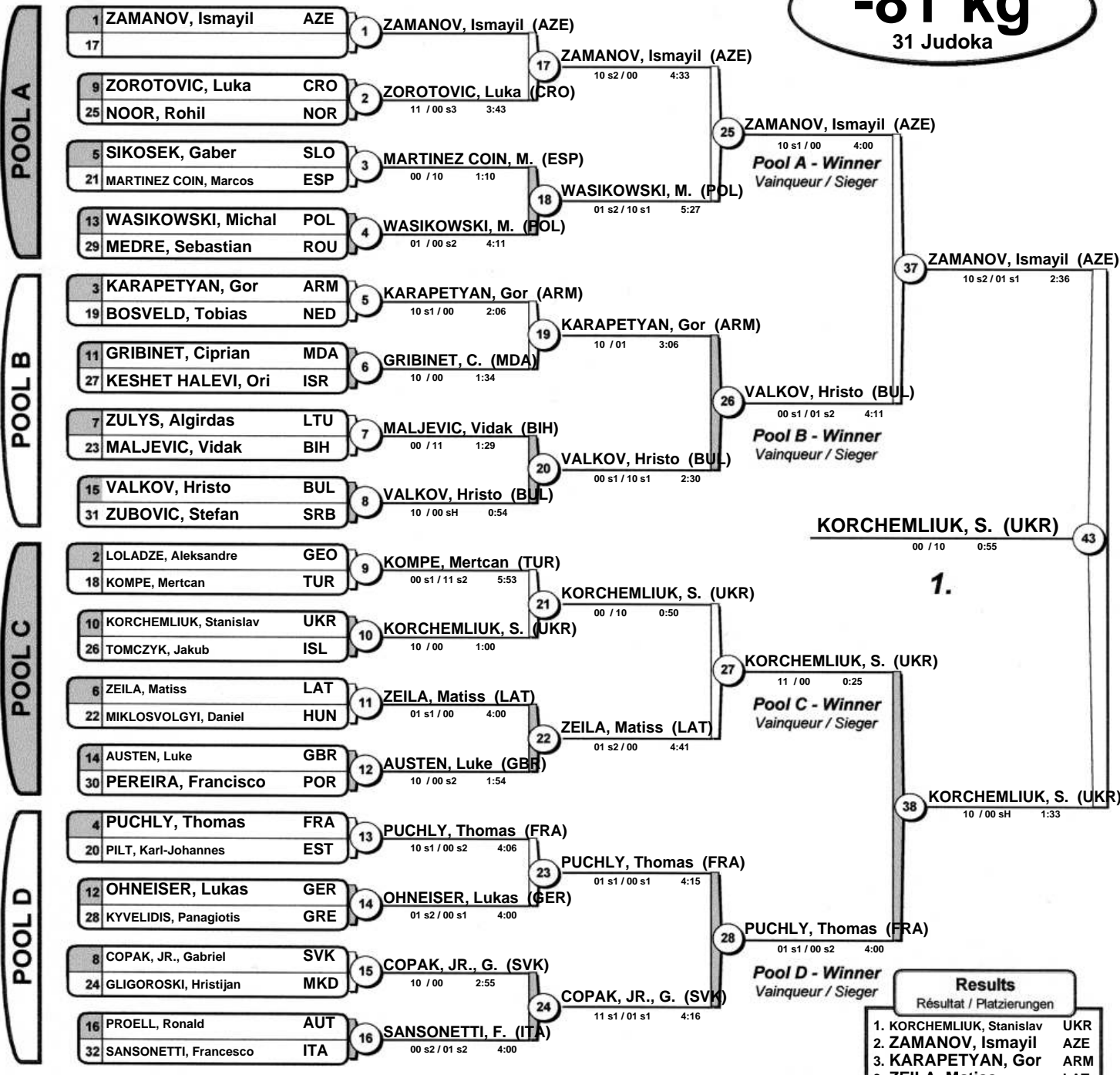

Results	
Résultat / Platzierungen	
1.	KORCHEVLIUK, Stanislav (UKR)
2.	ZAMANOV, Ismayil (AZE)
3.	KARAPETYAN, Gor (ARM)
4.	ZEILA, Matiss (LAT)
5.	PUCHLY, Thomas (FRA)
6.	VALKOV, Hristo (BUL)
7.	ZOROTOVIC, Luka (CRO)
8.	PILT, Karl-Johannes (EST)

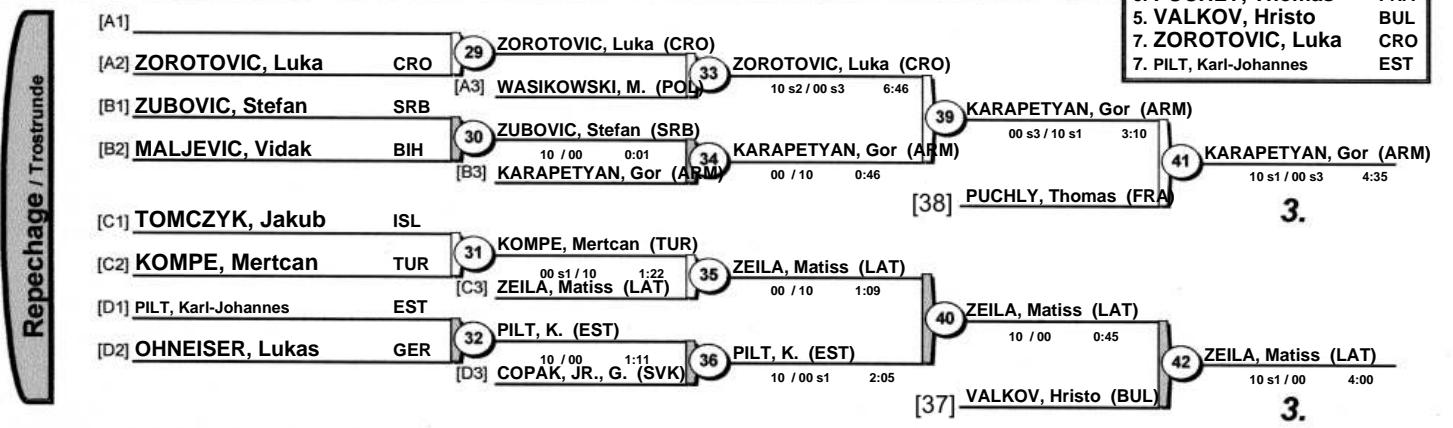

**-90 kg**  
24 Judoka

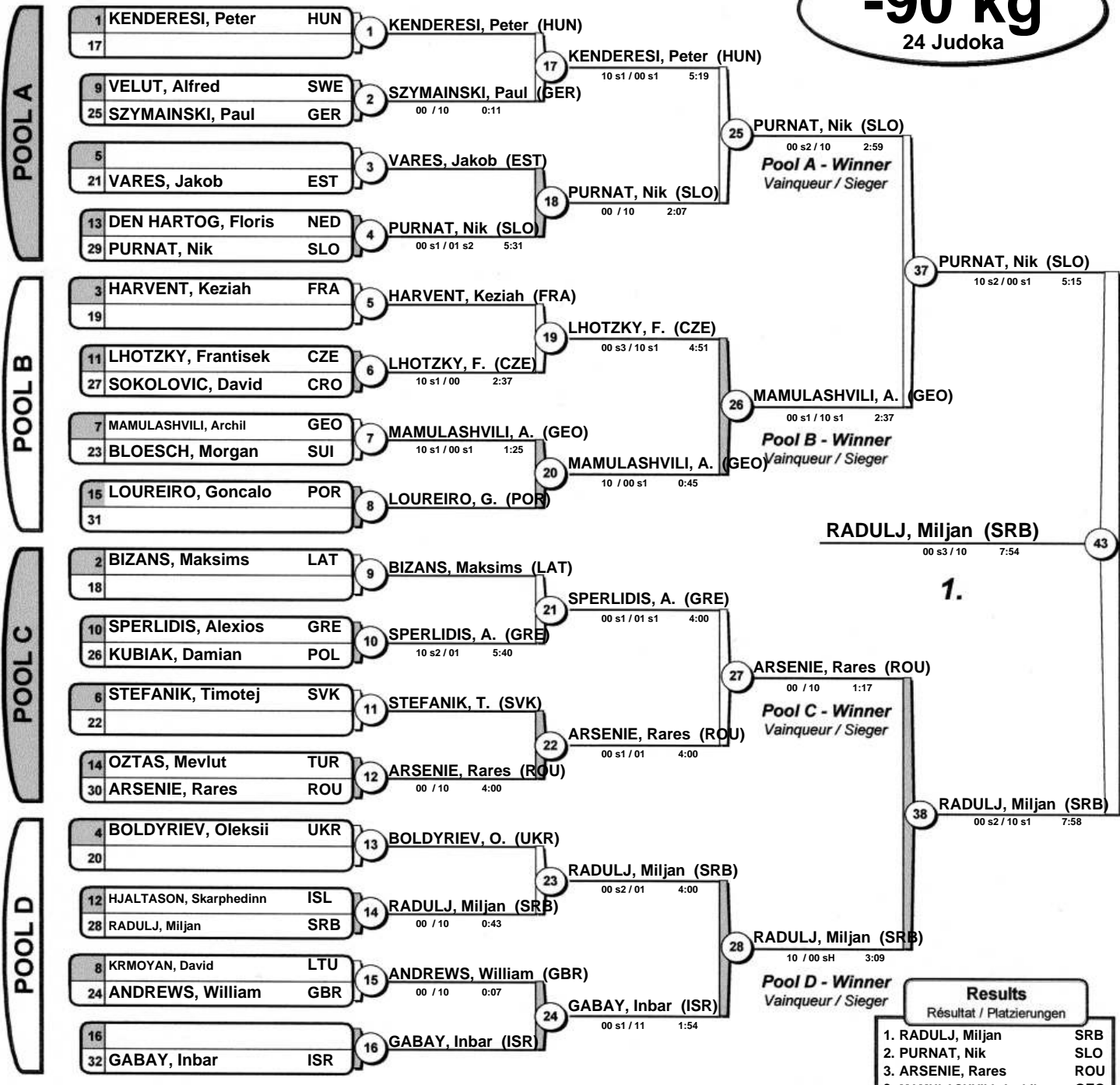

Results	
Résultat / Platzierungen	
1.	RADULJ, Miljan SRB
2.	PURNAT, Nik SLO
3.	ARSENIE, Rares ROU
3.	MAMULASHVILI, Archil GEO
5.	LHOTZKY, Frantisek CZE
5.	GABAY, Inbar ISR
7.	KENDERESI, Peter HUN
7.	SPERLIDIS, Alexios GRE

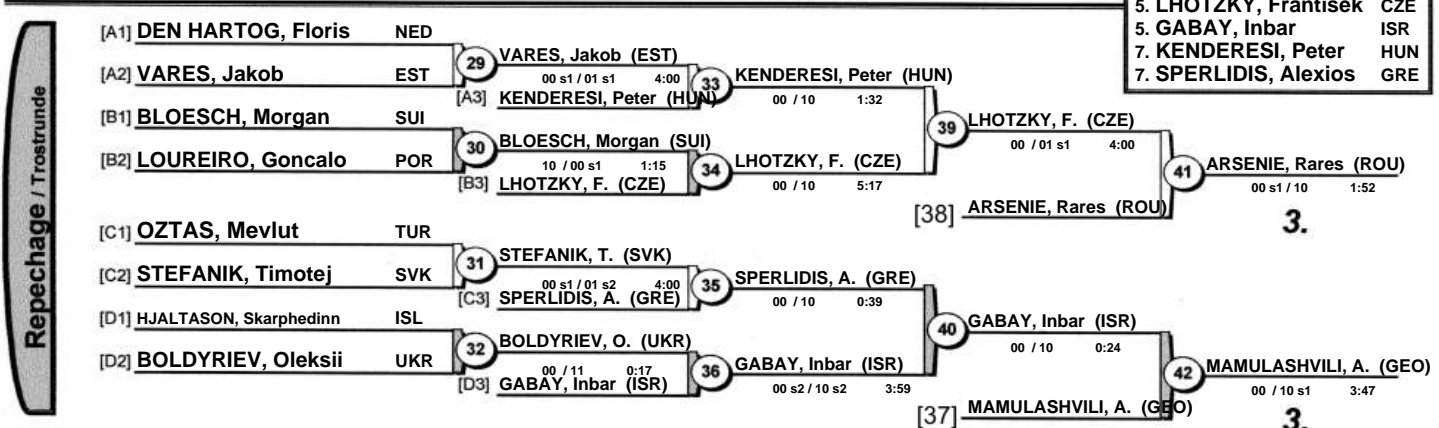



**-100 kg**  
8 Judoka

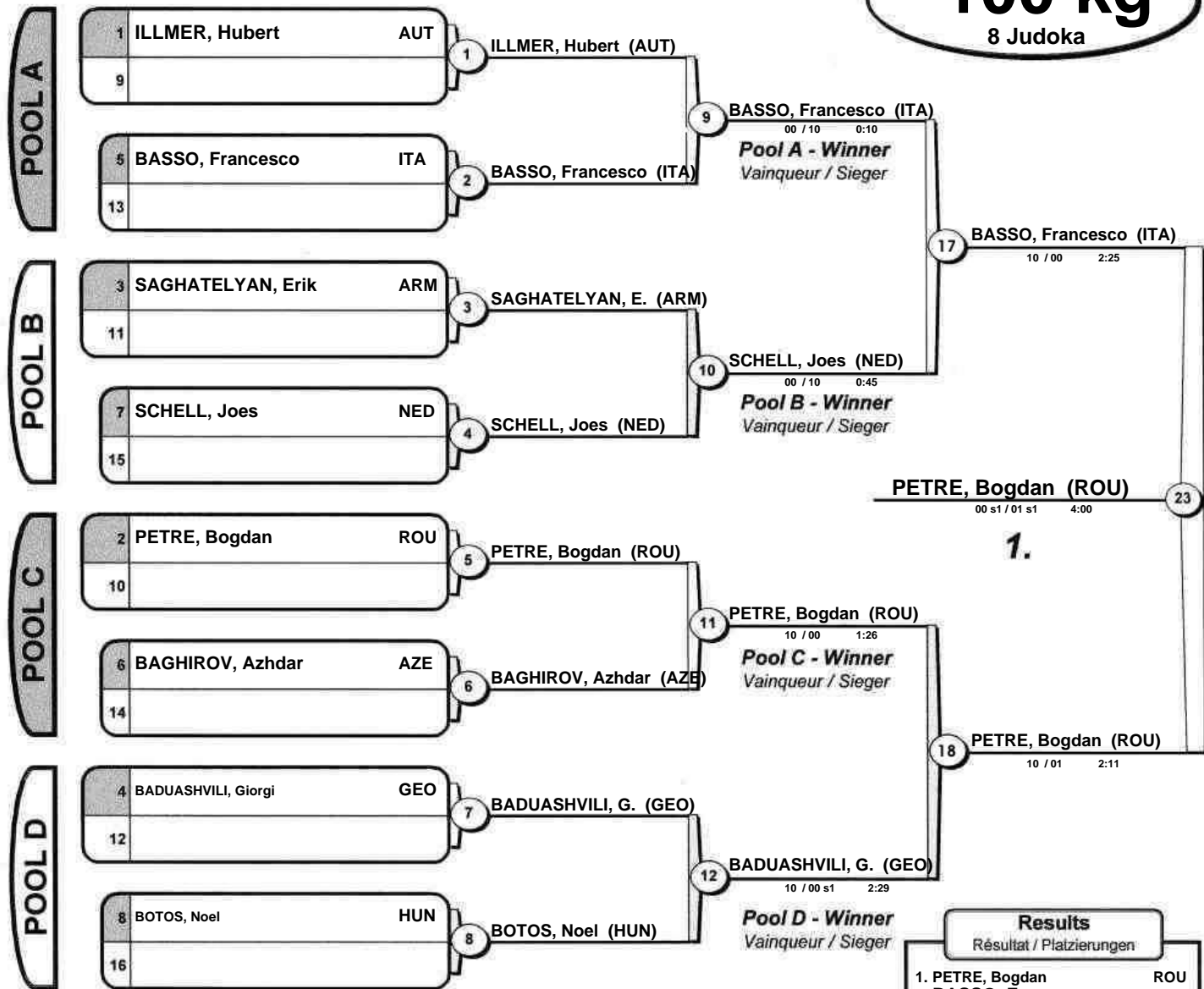

Results	
Résultat / Platzierungen	
1.	PETRE, Bogdan ROU
2.	BASSO, Francesco ITA
3.	BADUASHVILI, Giorgi GEO
3.	SCHELL, Joes NED
5.	SAGHATELYAN, Erik ARM
5.	BAGHIROV, Azhdar AZE
7.	ILLMER, Hubert AUT
7.	BOTOS, Noel HUN

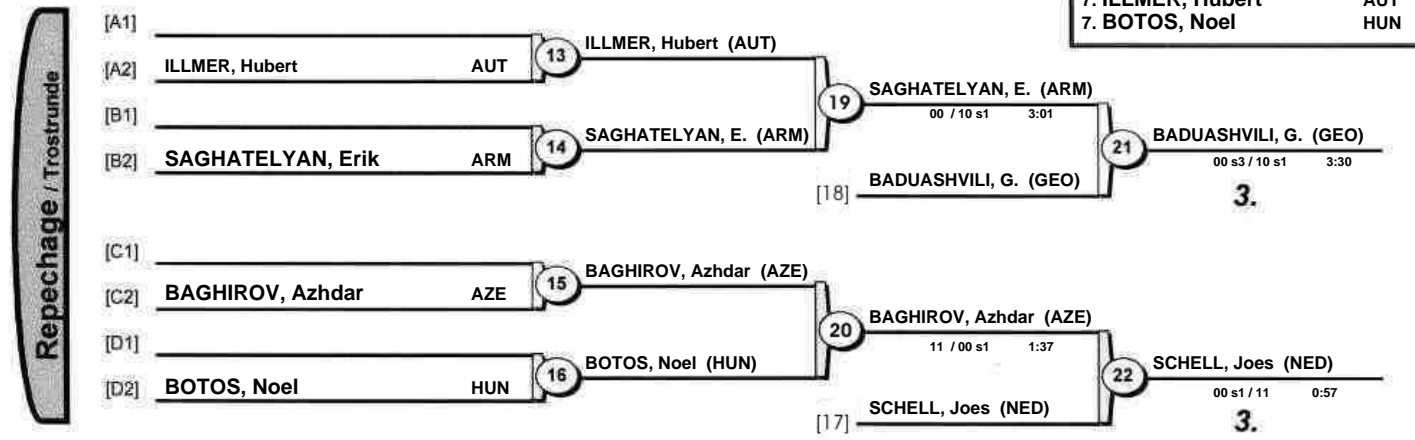

29-Jul-2022 - 17:02:25

**+100 kg**  
18 Judoka

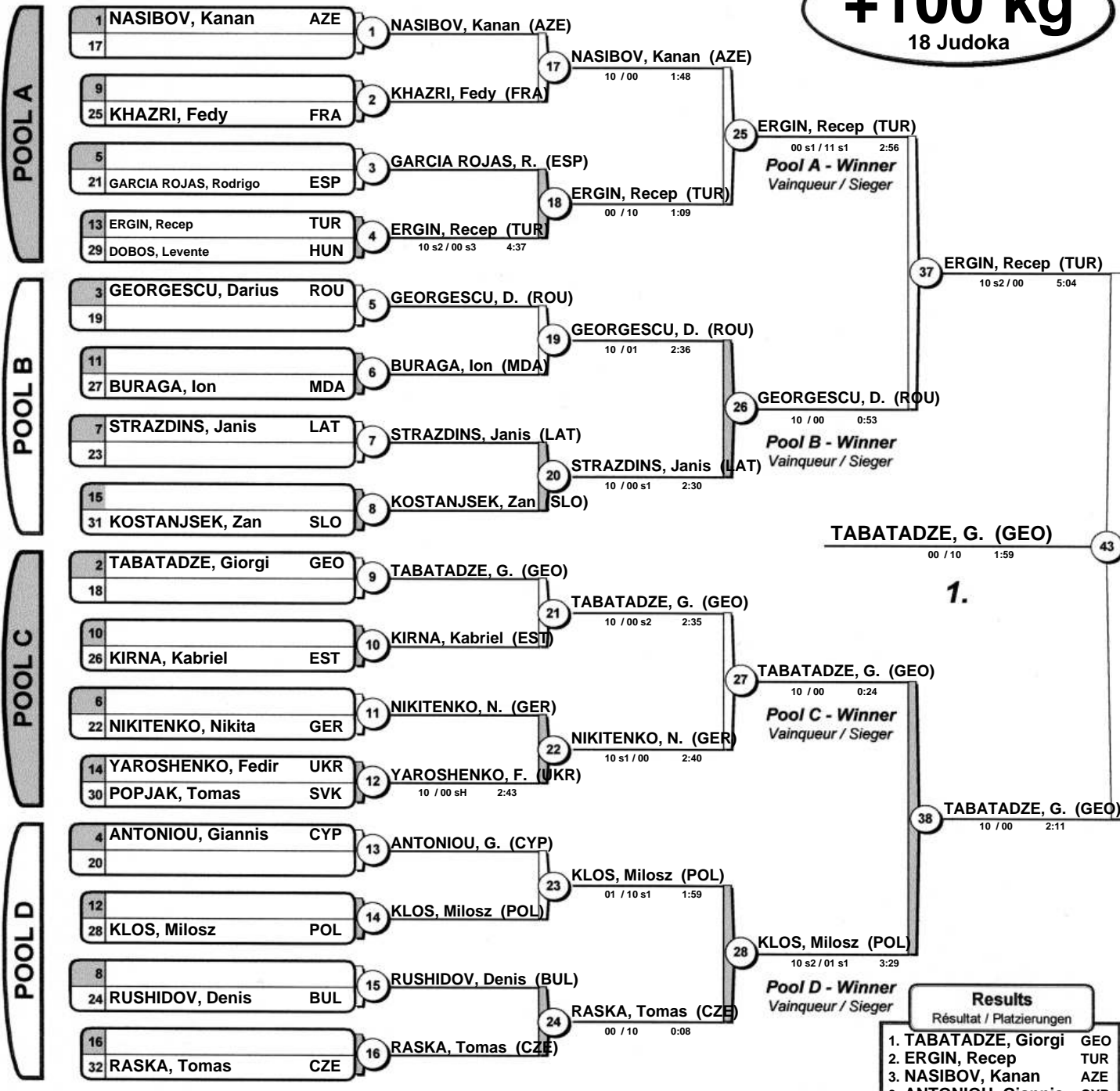

Results		
Résultat / Platzierungen		
1.	TABATADZE, Giorgi	GEO
2.	ERGIN, Recep	TUR
3.	NASIBOV, Kanan	AZE
4.	ANTONIOU, Giannis	CYP
5.	KLOS, Milosz	POL
6.	GEORGESCU, Darius	ROU
7.	STRAZDINS, Janis	LAT
8.	NIKITENKO, Nikita	GER

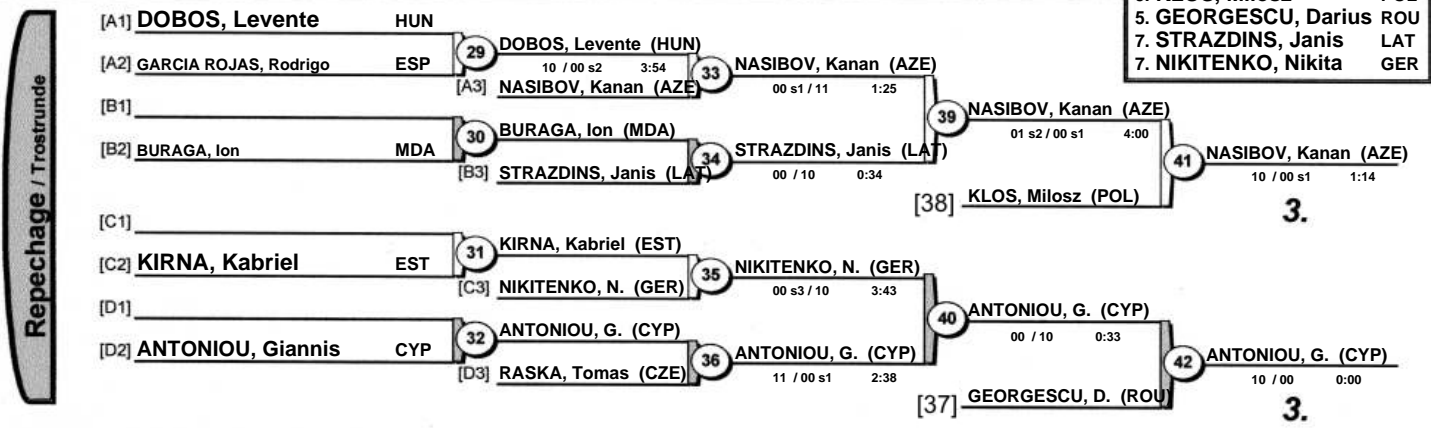



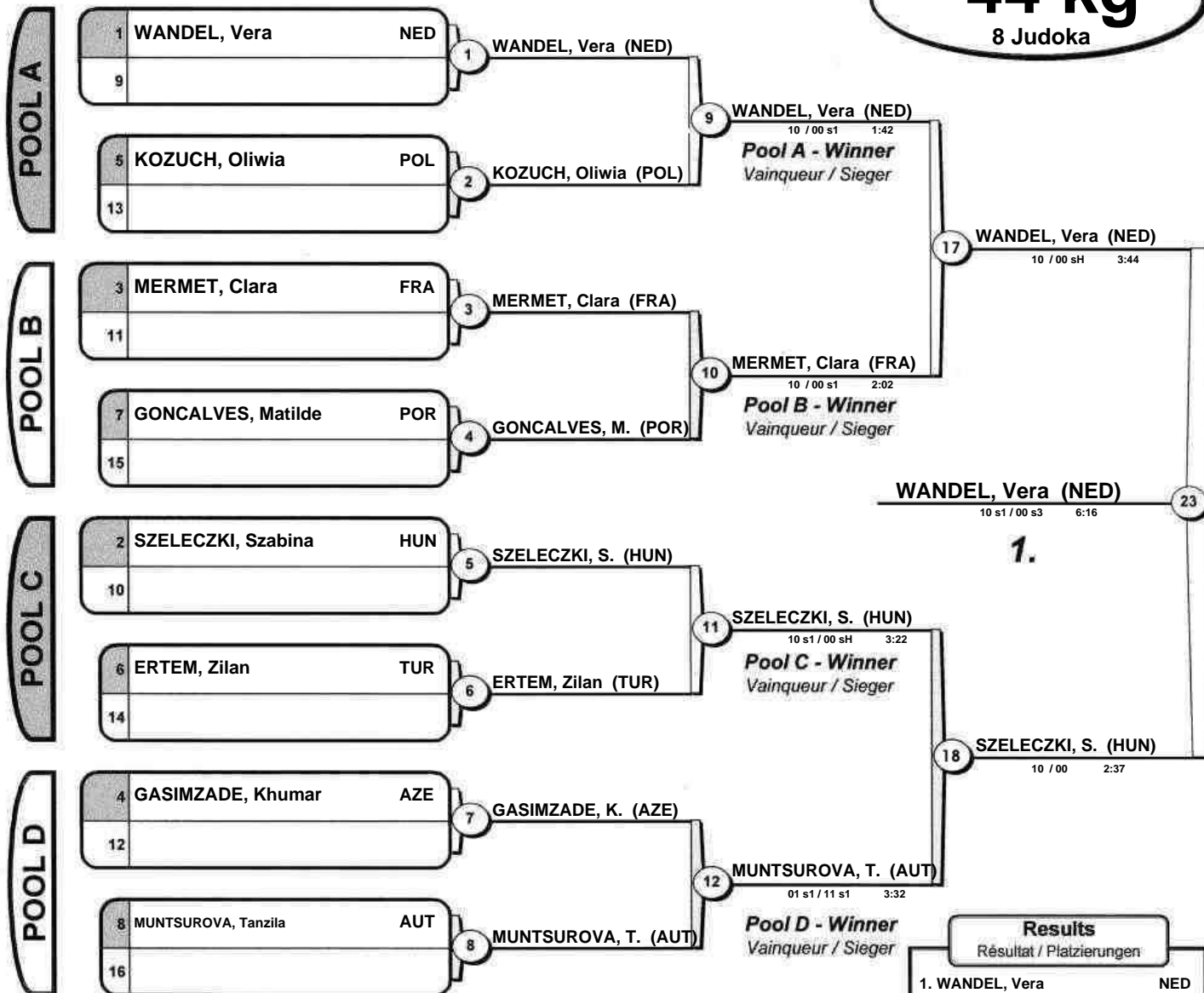

Results	
Résultat / Platzierungen	
1. WANEL, Vera	NED
2. SZELECZKI, Szabina	HUN
3. MUNTSUROVA, Tanzila	AUT
3. MERMET, Clara	FRA
5. KOZUCH, Oliwia	POL
7. GASIMZADE, Khumar	AZE
7. ERTEM, Zilan	TUR

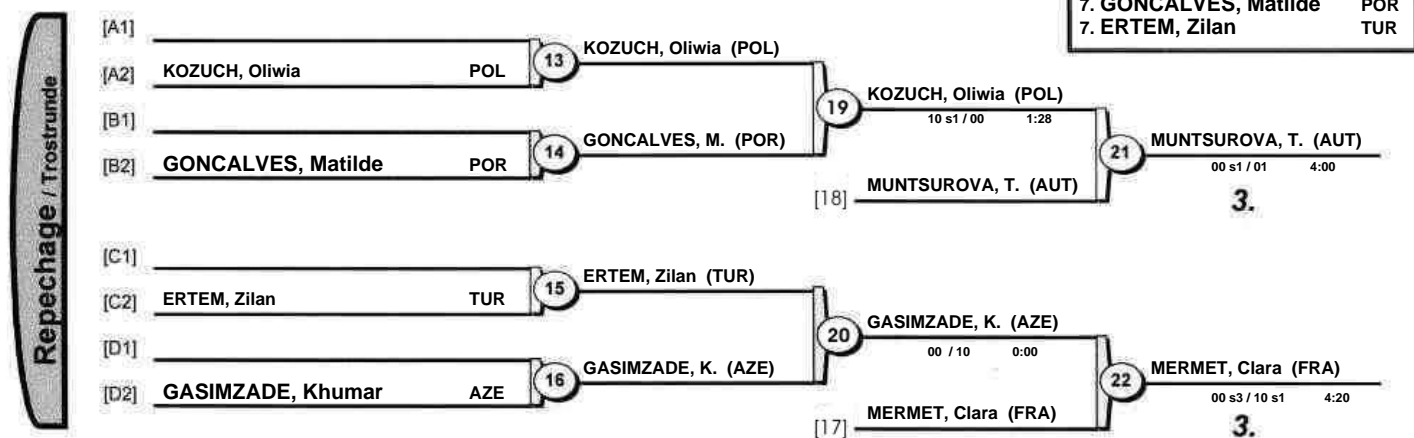

**-48 kg**  
12 Judoka

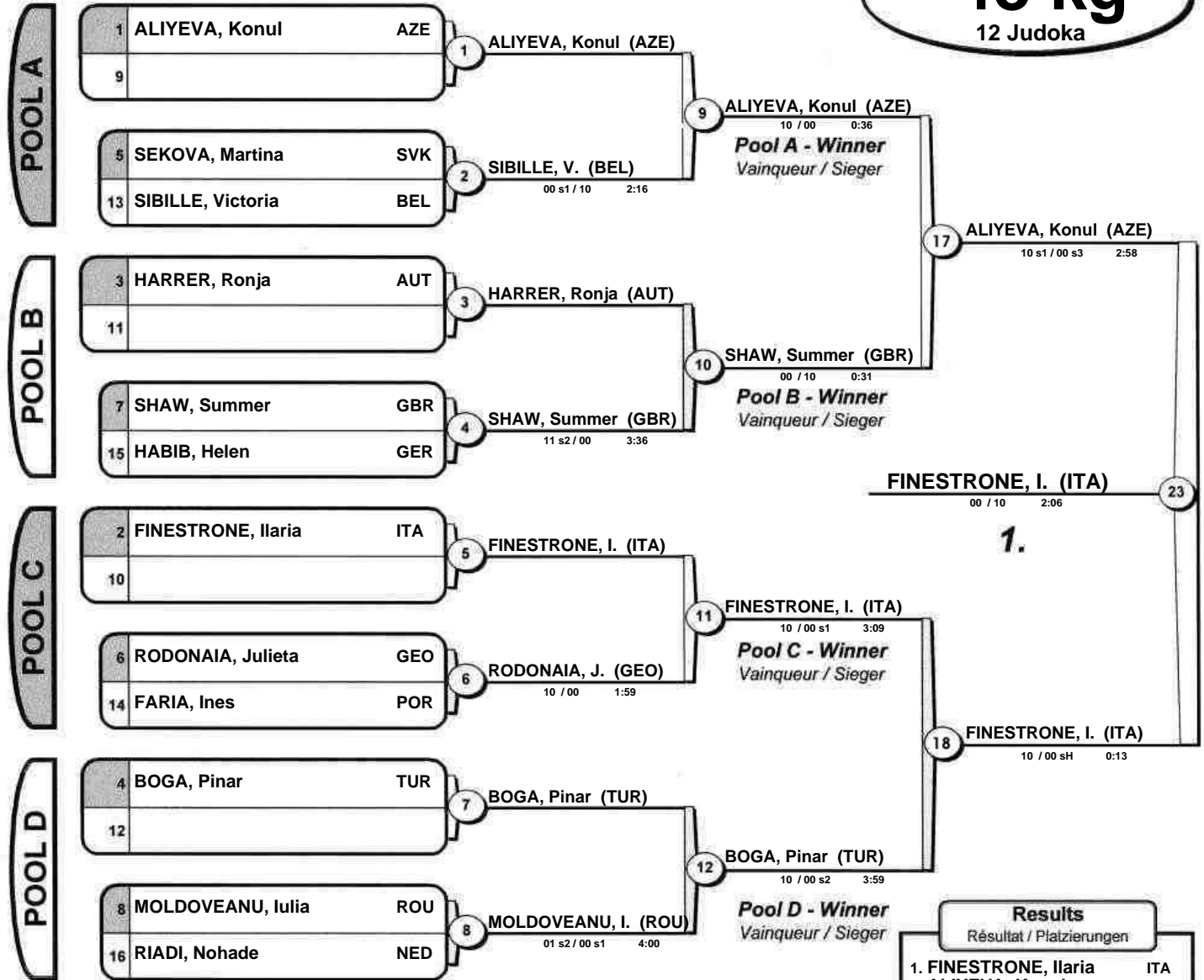

Results	
Résultat / Platzierungen	
1.	FINESTRONE, Ilaria ITA
2.	ALIYEVA, Konul AZE
3.	HABIB, Helen GER
3.	SHAW, Summer GBR
5.	BOGA, Pinar TUR
6.	RODONAIA, Julieta GEO
7.	SIBILLE, Victoria BEL
8.	MOLDOVEANU, Iulia ROU

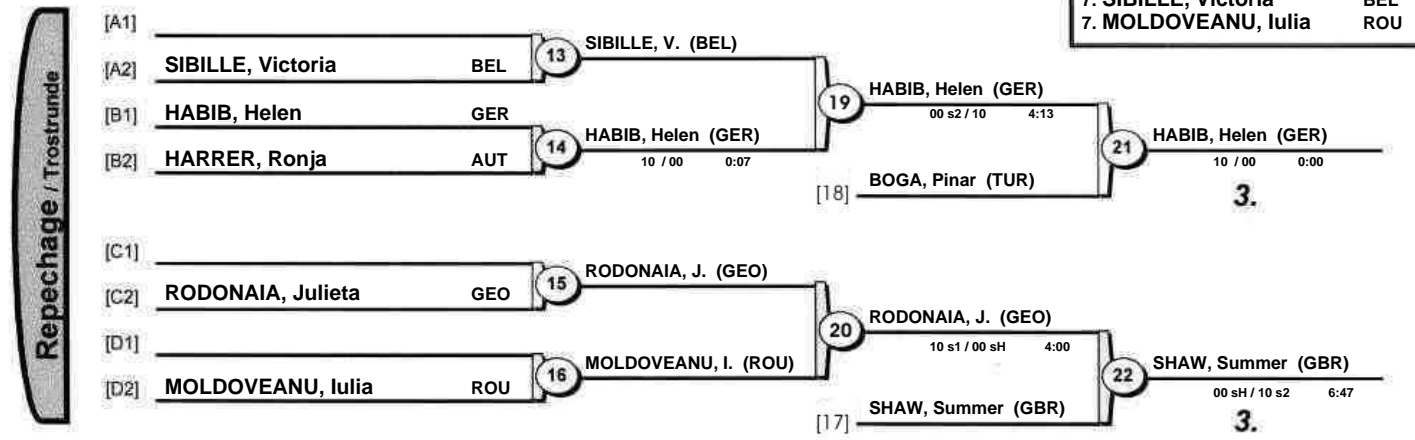









**-63 kg**  
23 Judoka

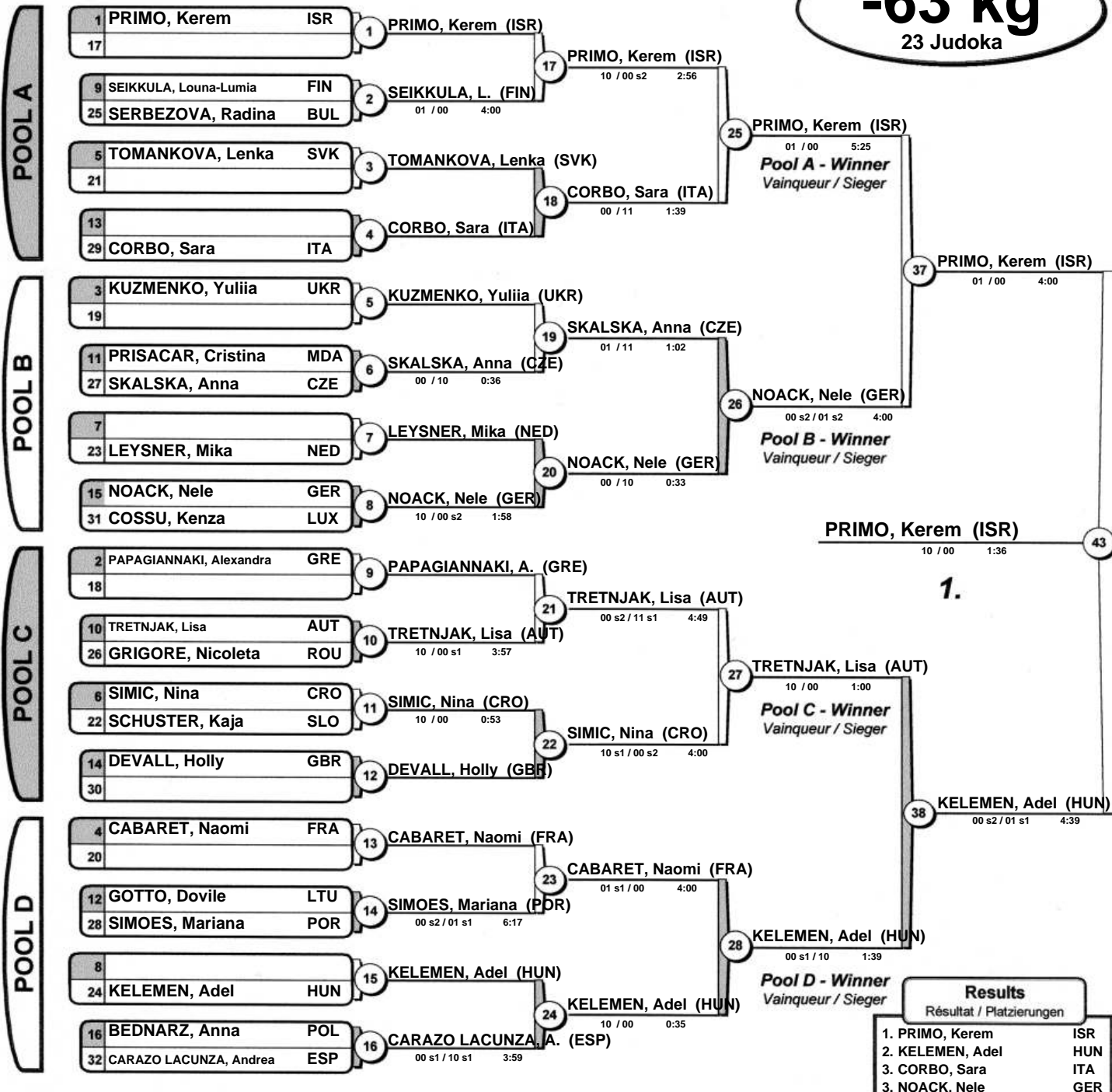

Results		
Résultat / Platzierungen		
1.	PRIMO, Kerem	ISR
2.	KELEMEN, Adel	HUN
3.	CORBO, Sara	ITA
3.	NOACK, Nele	GER
5.	TRETNJAK, Lisa	AUT
7.	CABARET, Naomi	FRA
7.	LEYSNER, Mika	NED
7.	SIMIC, Nina	CRO

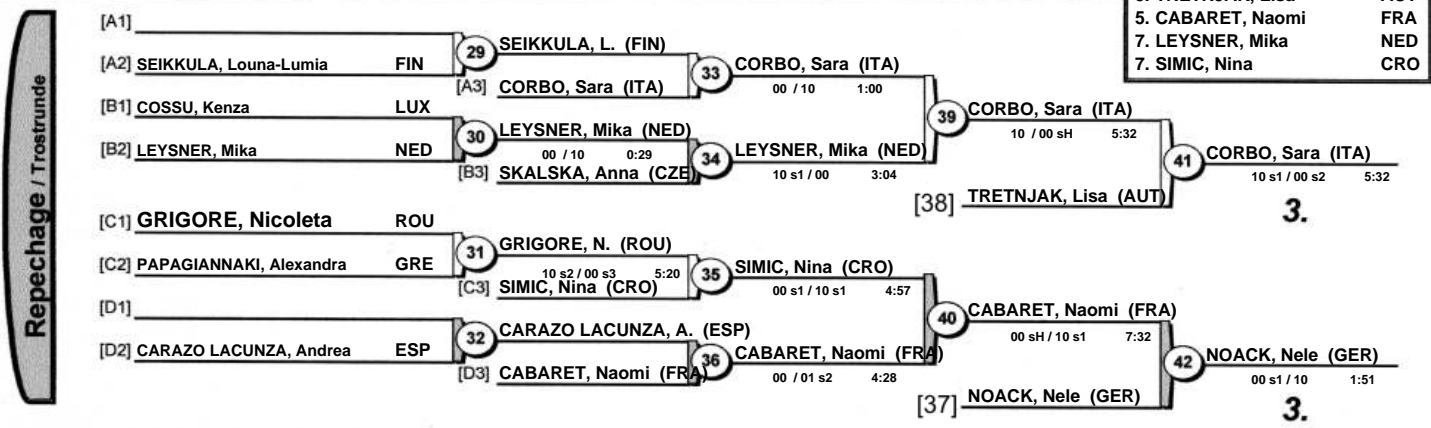

**-70 kg**  
21 Judoka

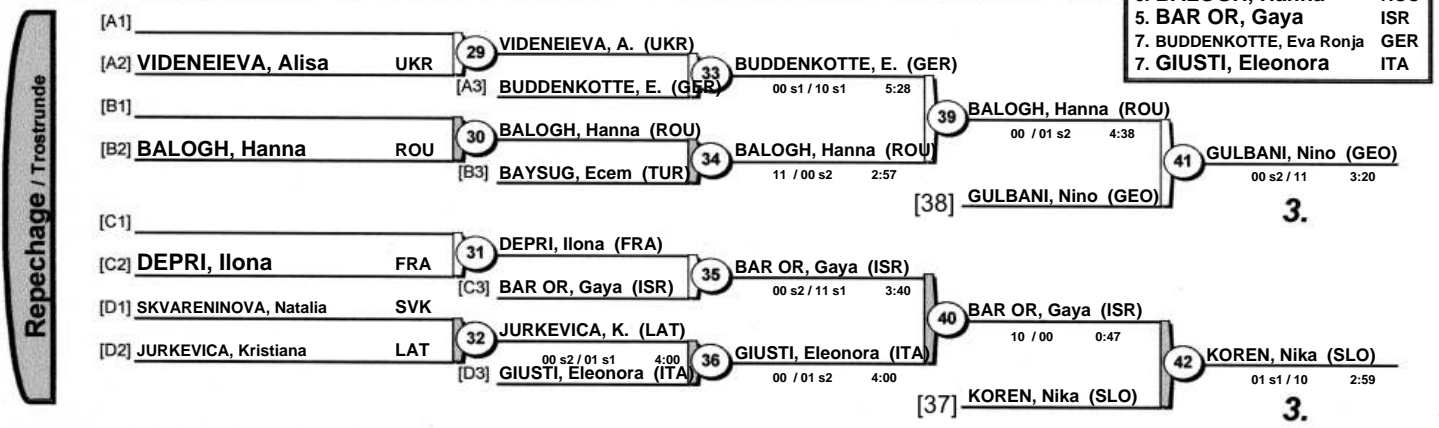
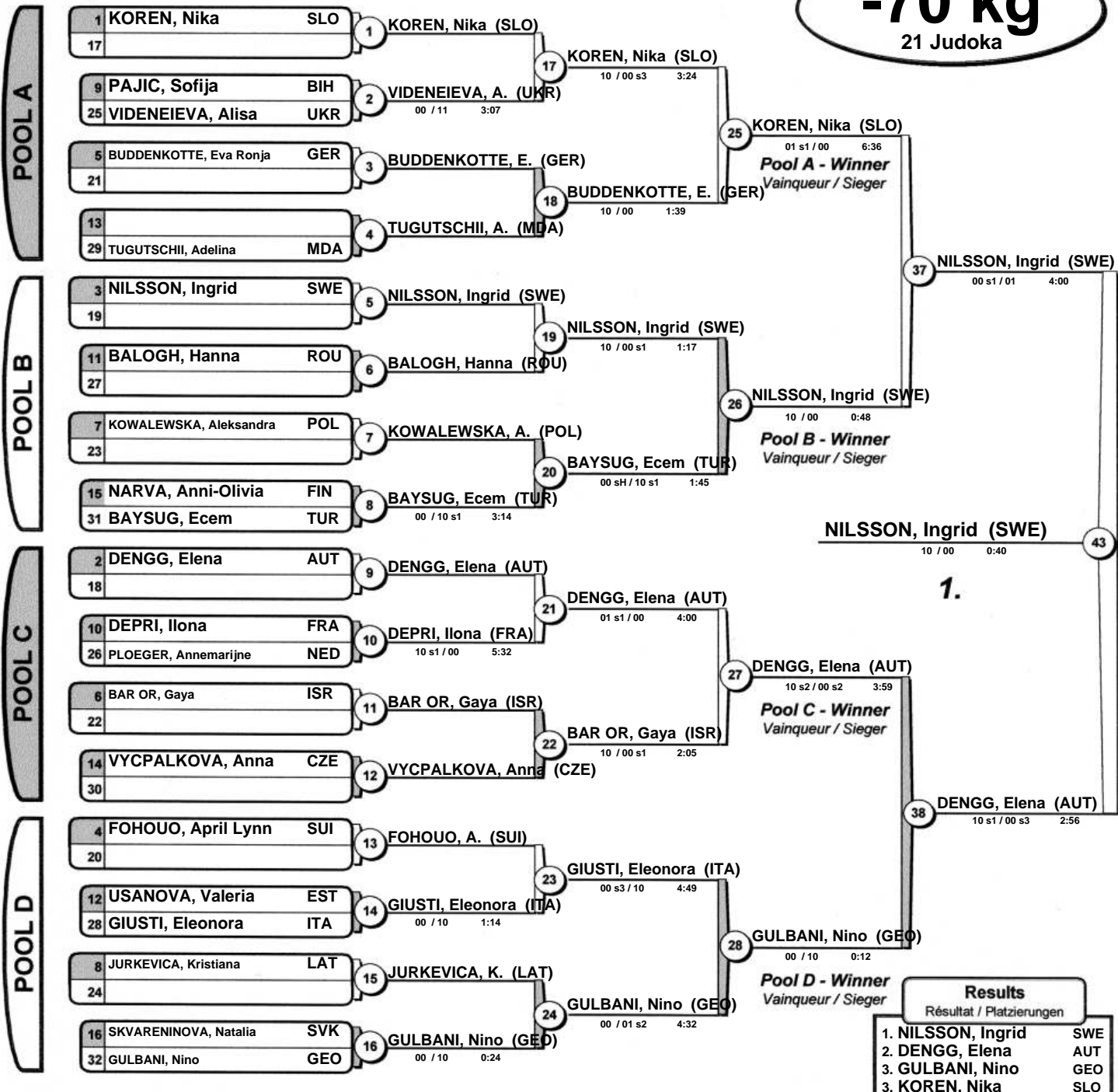

Results	
Résultat / Platzierungen	
1.	NILSSON, Ingrid (SWE)
2.	DENG, Elena (AUT)
3.	GULBANI, Nino (GEO)
4.	KOREN, Nika (SLO)
5.	BALOGH, Hanna (ROU)
6.	BAR OR, Gaya (ISR)
7.	BUDDENKOTTE, Eva Ronja (GER)
8.	GIUSTI, Eleonora (ITA)



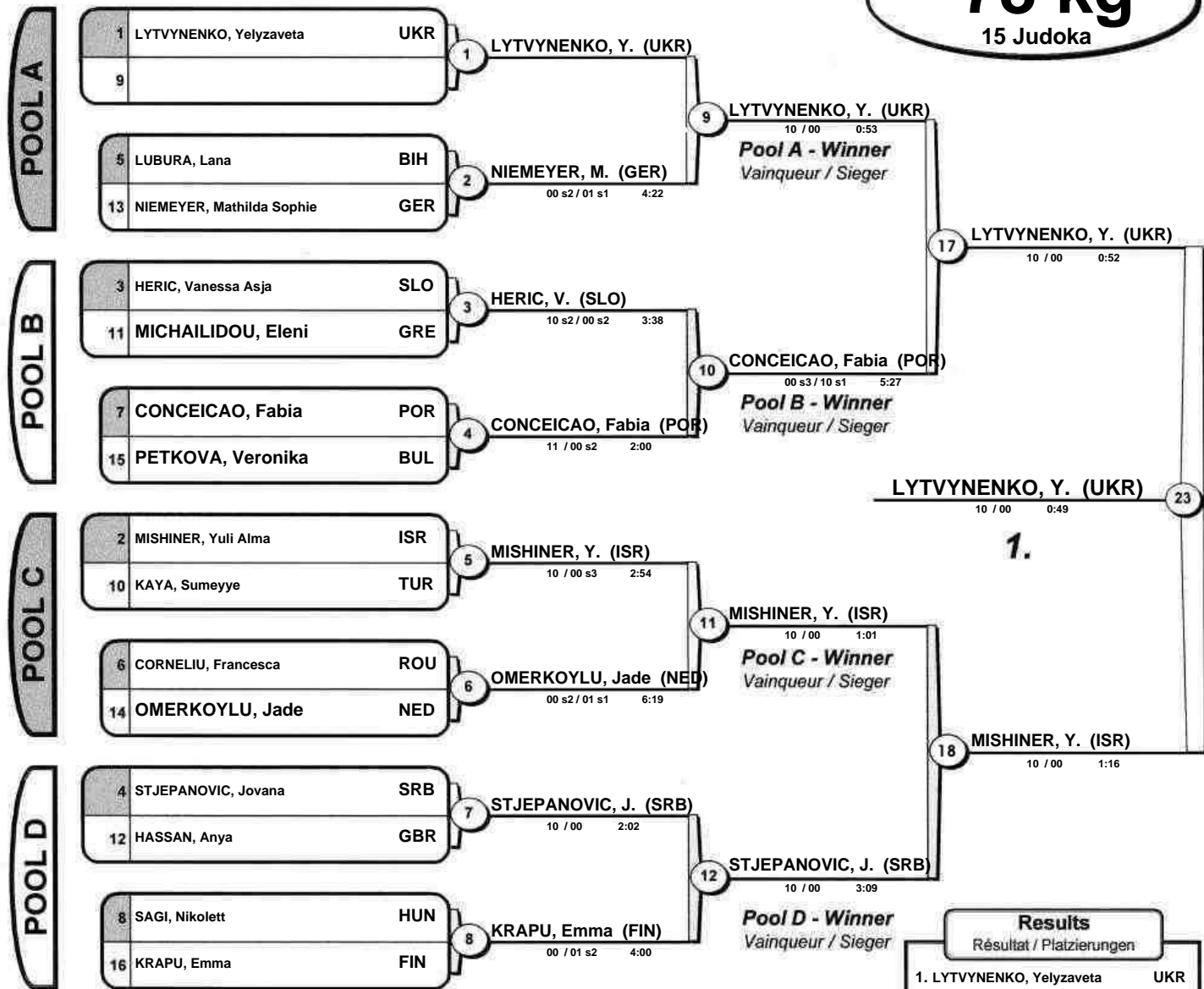

Results	
Résultat / Platzierungen	
1.	LYTVYENKO, Yelyzaveta UKR
2.	MISHINER, Yuli Alma ISR
3.	NIEMEYER, Mathilda Sophie GER
3.	CONCEICAO, Fabia POR
5.	STJEPANOVIC, Jovana SRB
5.	KAYA, Sumeyye TUR
7.	HERIC, Vanessa Asja SLO
7.	KRAPU, Emma FIN

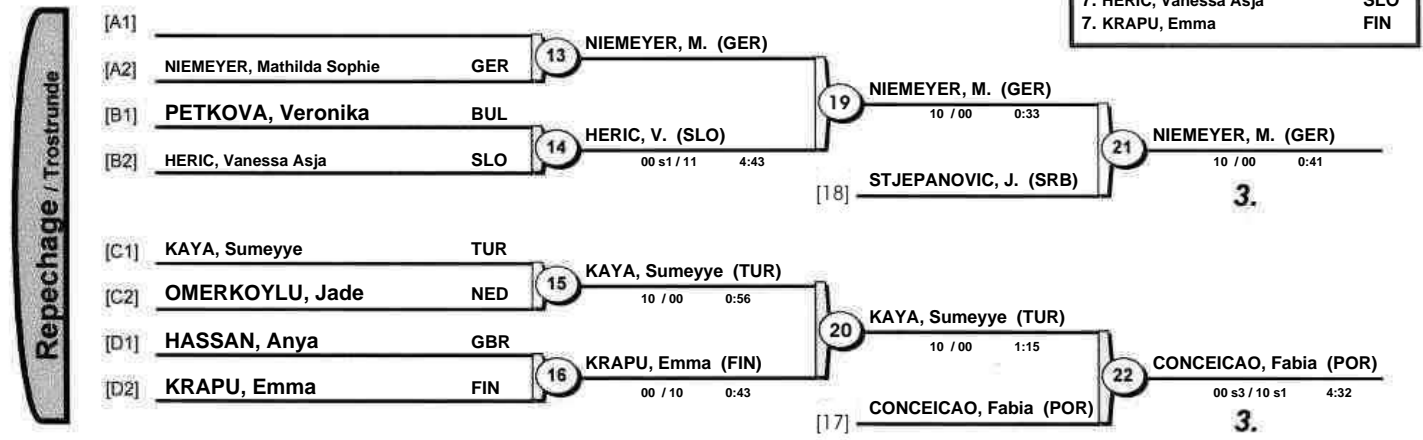

	1	3	5	Wins	Score
1 DE PAOLI, Morgana ITA		0	1	1	0
3 LANG, Bintibe FRA	1		1	2	0
5 SULEYMANOVA, Nigar AZE	0	0		0	0

	2	4	Wins	Scores
2 SEMCHENKO, Diana UKR		1		(0)
4 VRANJES, Marcelina CRO	0			(0)

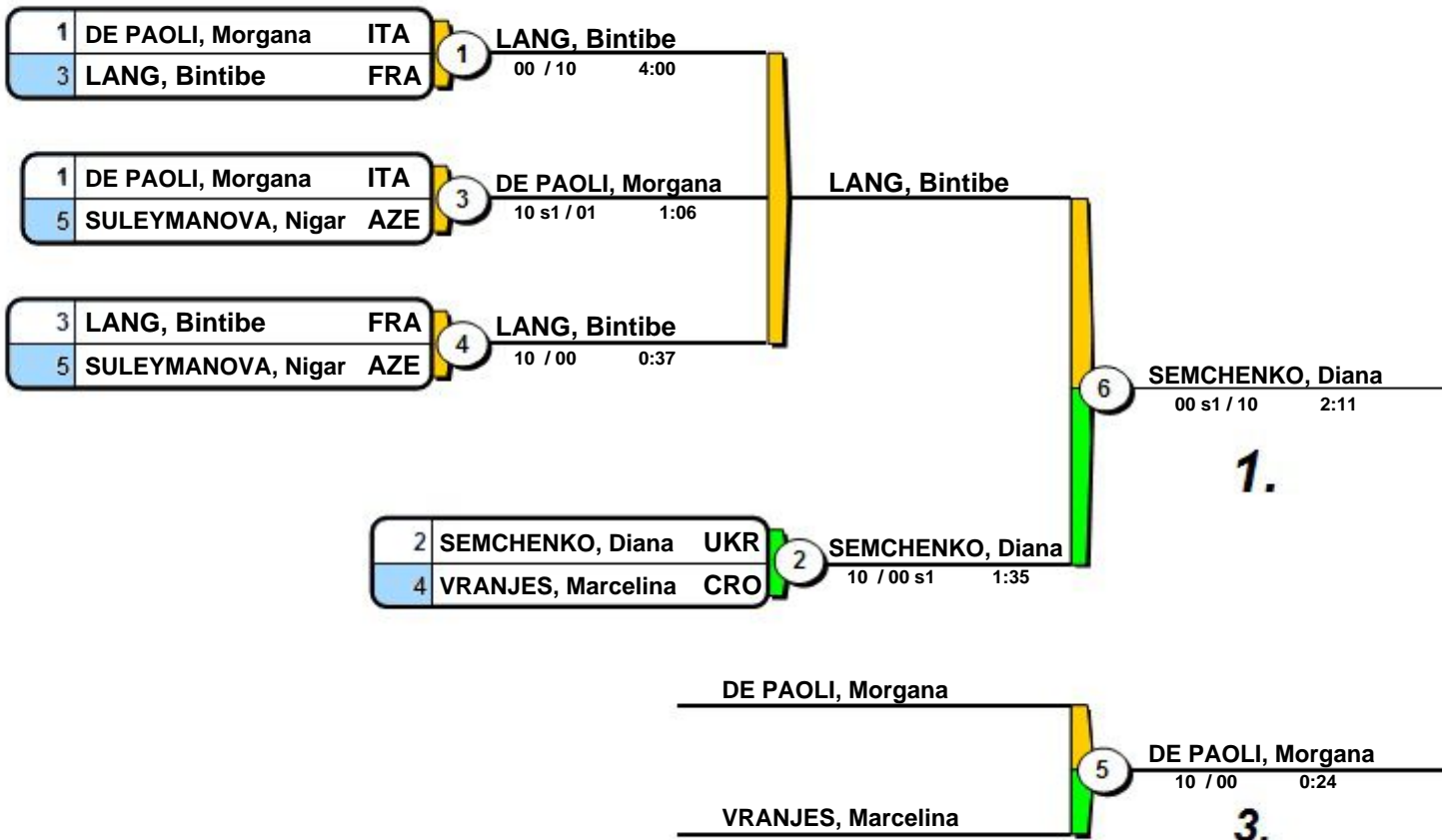

## Final Results

1. SEMCHENKO, Diana UKR
2. LANG, Bintibe FRA
3. DE PAOLI, Morgana ITA