

# BALKAN CHAMPIONSHIP U15

Niksic (MNE), 07-08 Jul 2018

## Nations Overview

			-34	-38	-42	-46	-50	-55	-60	-66	-73	+73	m	-32	-36	-40	-44	-48	-52	-57	-63	+63	w	
1.		ALB Albania											0					2					2	
2.		BIH Bosnia-Herzegovina	2	1	2	2	2	2	2	2	2	2	19		1	2	1	2	2	2	2	2	2	14
3.		BUL Bulgaria	2	2	1	2	2	2		1	1	2	15	1	2	1	1	2	2	2	2	2	1	14
4.		GRE Greece	1	2	2	2	2	1	2	2	2	2	18		1	1	2	2	2	2	2	1	2	13
5.		KOS Kosovo											0				1		1					2
6.		MKD Macedonia			1		1			1	1		4					1		2		1		4
7.		MNE Montenegro		1	2	2	2	2	2	2	2	2	17	1			2	2	2	1	2	1		11
8.		ROU Romania	2	2	1	2	2	1	2	2	2	2	18	2	2	2	1	2	2	2	2	2	2	17
9.		TUR Turkey	2	2	2	2	2	2	2	2	2	2	20	2	2	2	2	2	2	2	2	2	2	18
			9	10	11	12	13	10	10	12	12	12	111	6	8	8	10	15	13	13	11	11		95

BALKAN JUDO ASSOCIATION  
 Deniz ŞILLI  
 General Secretary

**BALKAN CHAMPIONSHIP U15**  
**Niksic (MNE) 07-08 JUL 2018**

Rank:		Gold:	Silver:	Bronze:
1.	TURKEY	11	9	8
2.	MONTENEGRO	3	0	6
3.	ROMANIA	1	5	11
4.	BULGARIA	1	3	6
5.	BOSNIA&HERZEGOVINA	1	1	6
6.	MACEDONIA	1	1	0
7.	GREECE	1	0	1
8.	ALBANIA	0	0	0
9.	KOSOVO	0	0	0

  
BALKAN JUDO ASSOCIATION  
Deniz ŞİLİ  
General Secretary

# BALKAN CHAMPIONSHIP U15

Niksic (MNE), 07-08 Jul 2018

## -32 kg

6 Judoka

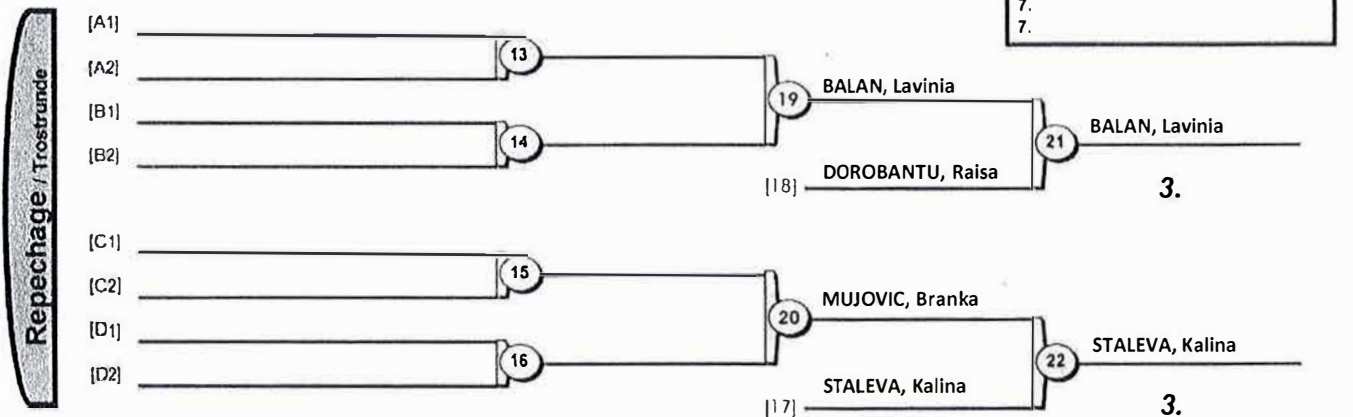
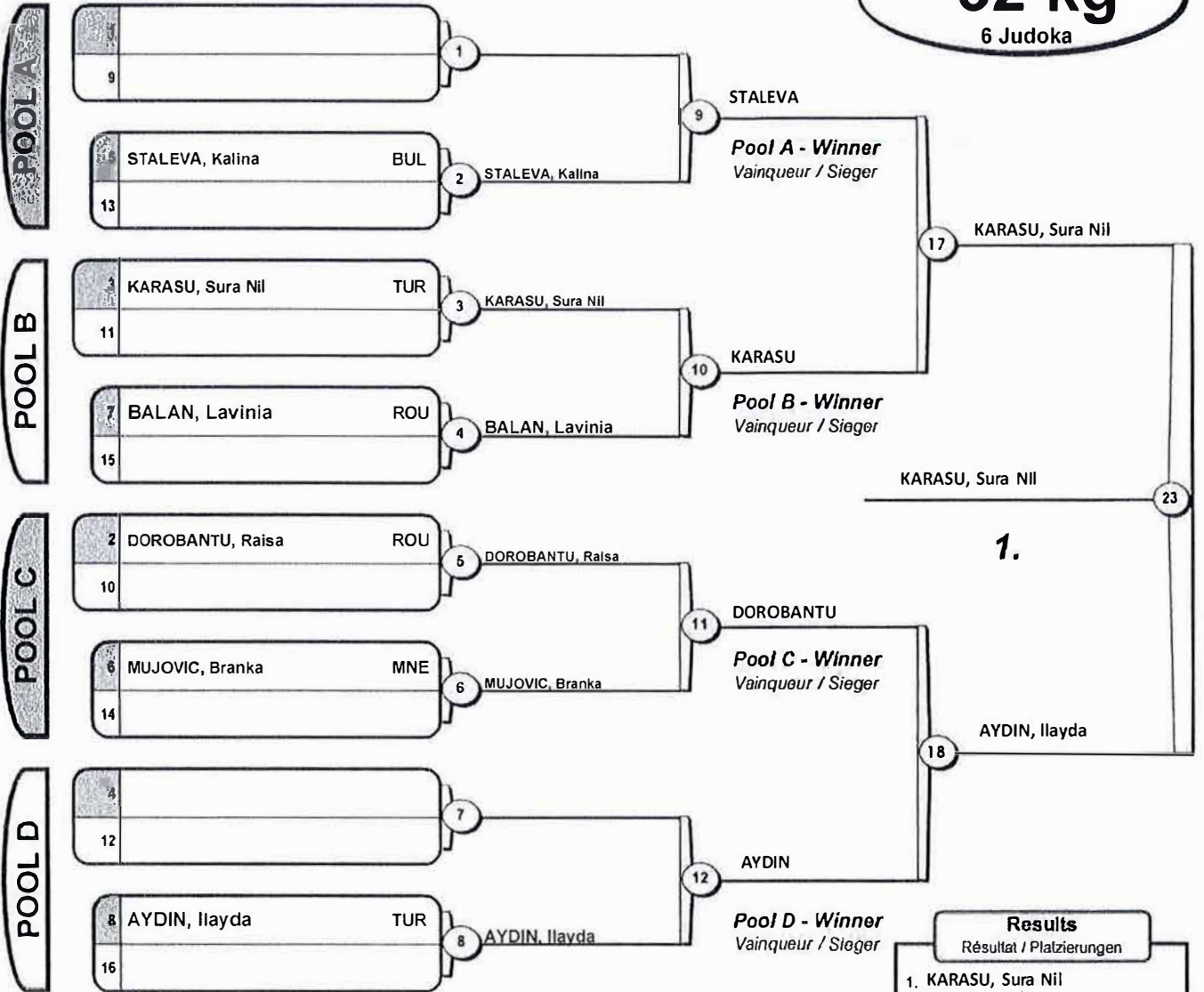

BALKAN JUDO ASSOCIATION  
Deniz ŞALLI  
General Secretary

# BALKAN CHAMPIONSHIP U15

Niksic (MNE), 07-08 Jul 2018

## -36 kg

8 Judoka

POOL A

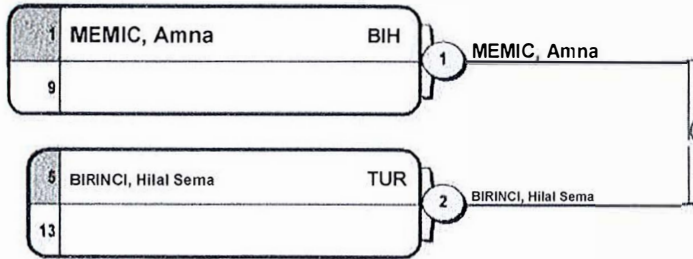

**Pool A - Winner**  
Vainqueur / Sieger

POOL B

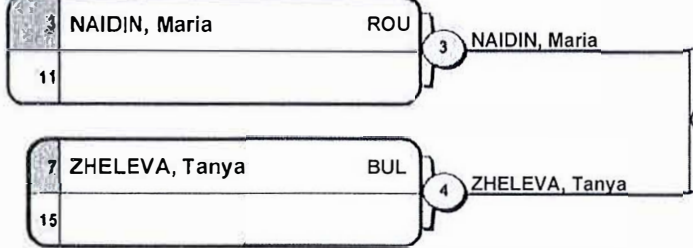

**Pool B - Winner**  
Vainqueur / Sieger

POOL C

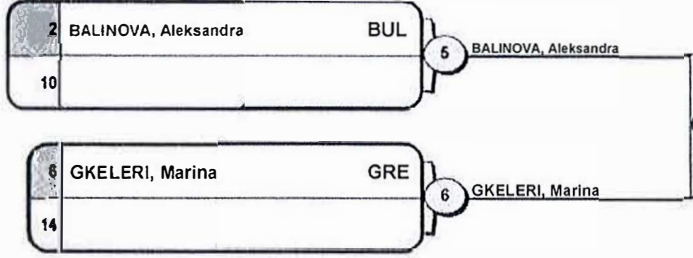

**Pool C - Winner**  
Vainqueur / Sieger

POOL D

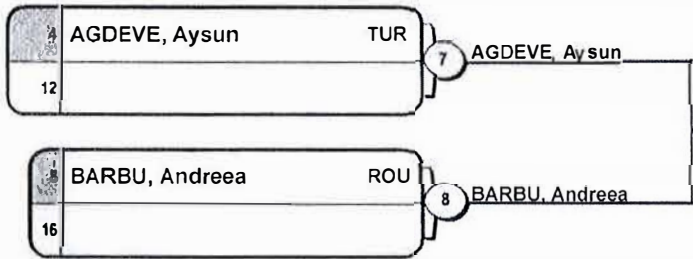

**Pool D - Winner**  
Vainqueur / Sieger

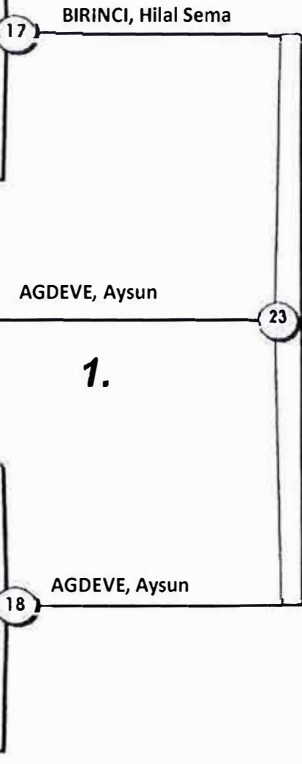

1.

### Results

Résultat / Platzierungen

1. AGDEVE, Aysun (Turkey)
2. BIRINCI, Hilal Sema (Turkey)
3. BALINOVA, Aleksandra (Bulgaria)
3. BARBU, Andreea (Romania)
5. ZHELEVA, Tanya (Bulgaria)
5. NAIDIN, Maria (Romania)
7. MEMIC, Amna (BiH)
7. GKELERI, Marina (Greece)

Repechage / Trostrunde

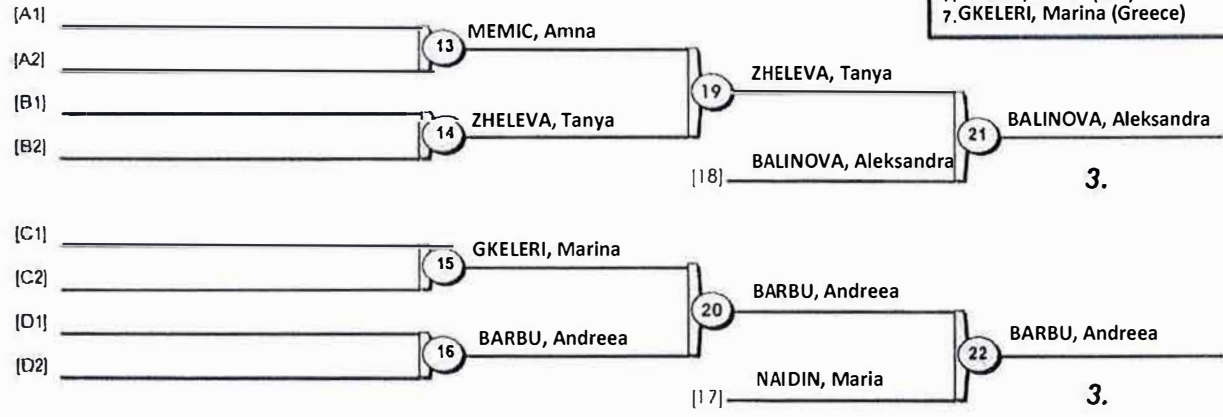

# BALKAN CHAMPIONSHIP U15

Niksic (MNE), 07-08 Jul 2018

**-40 kg**

8 Judoka

**POOL A**

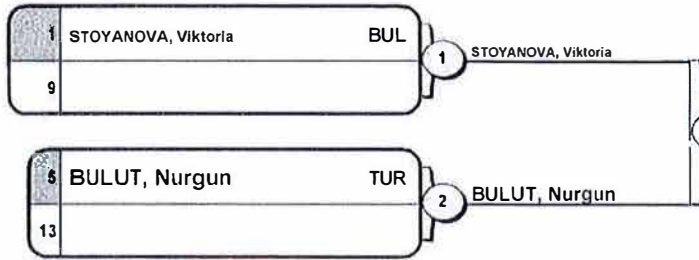

**Pool A - Winner**  
Vainqueur / Sieger

**POOL B**

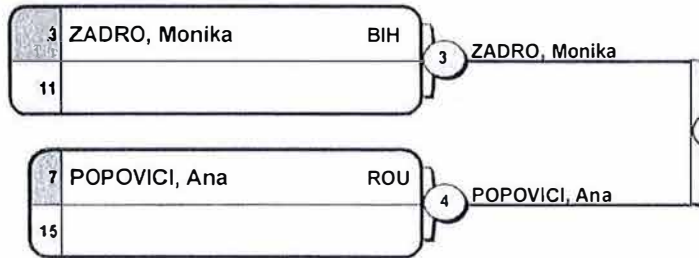

**Pool B - Winner**  
Vainqueur / Sieger

**POOL C**

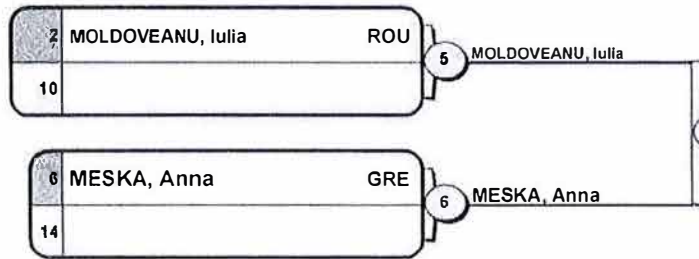

**Pool C - Winner**  
Vainqueur / Sieger

**POOL D**

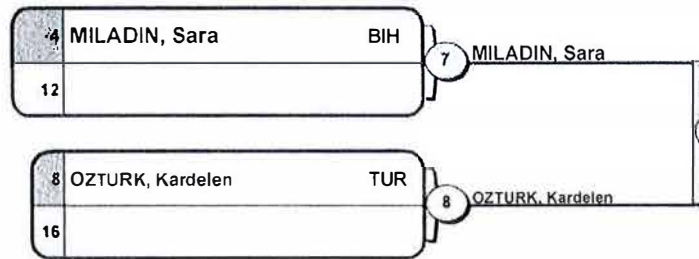

**Pool D - Winner**  
Vainqueur / Sieger

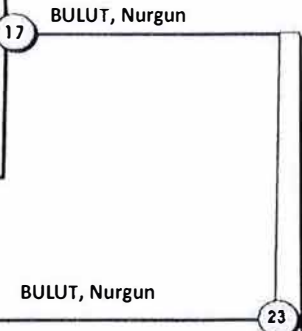

**1.**

BULUT, Nurgun

- Results**  
Résultat / Platzierungen
1. BULUT, Nurgun (Turkey)
  2. MOLDOVEANU, Iulia (Romania)
  3. OZTURK, Kardelen (Turkey)
  3. POPOVICI, Ana (Romania)
  5. STOYANOVA, Viktoria (Bulgaria)
  5. MILADIN, Sara (BiH)
  7. ZADRO, Monika (BiH)
  7. MESKA, Anna (Greece)

**Repechage / Trostrunde**

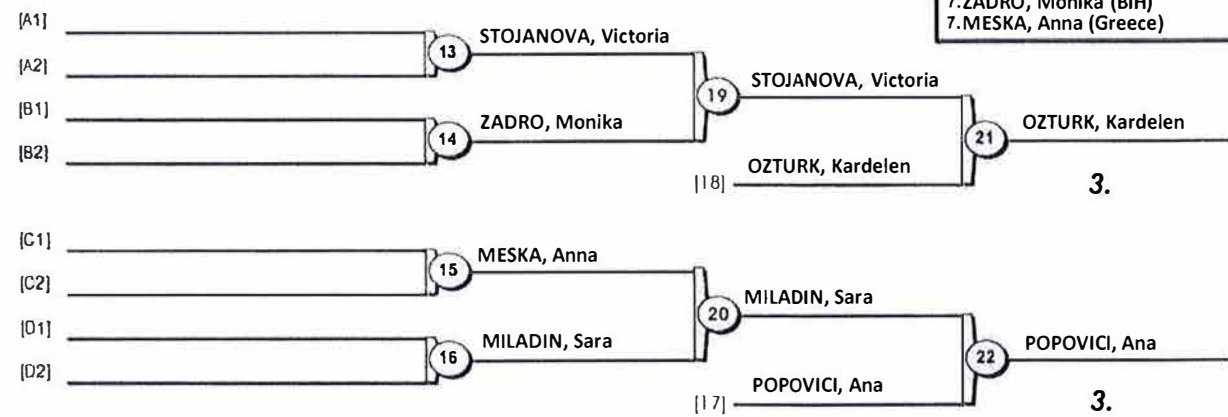

**3.**

**3.**



# BALKAN CHAMPIONSHIP U15

Nišić (MNE), 07-08 Jul 2018

## -44 kg

10 Judoka

POOL A

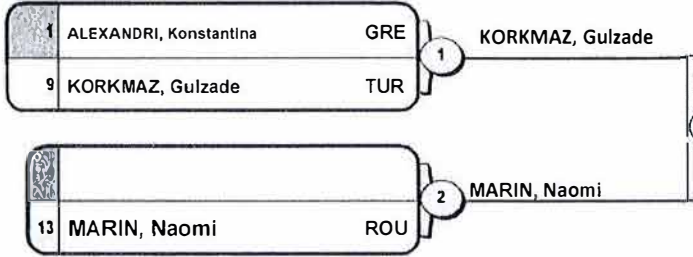

POOL B

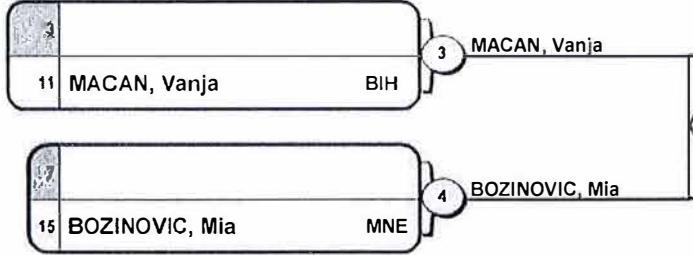

POOL C

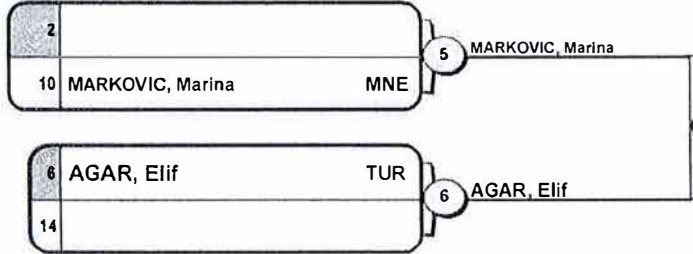

POOL D

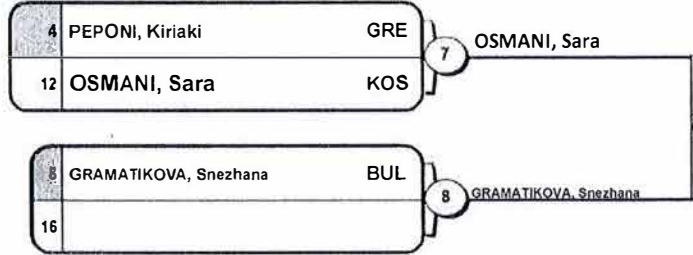

KORKMAZ, Gulzade

1.

- Results**  
Résultat / Platzierungen
1. KORKMAZ, Gulzade (Turkey)
  2. AGAR, Elif (Turkey)
  3. MARIN, Naomi (Romania)
  3. MARKOVIC, Marina (Montenegro)
  5. GRAMATIKOVA, Snezhana (Bulgaria)
  5. MACAN, Vanja (BiH)
  7. BOZINOVIC, Mia (Montenegro)
  7. OSMANI, Sara (Kosovo)

Repechage / Trostrunde

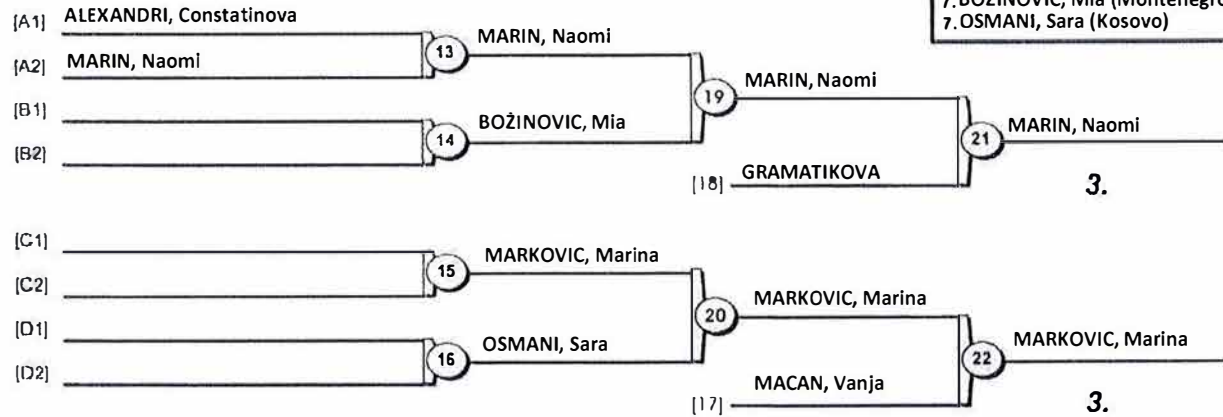

# BALKAN CHAMPIONSHIP U15

Niksic (MNE), 07-08 Jul 2018

## -48 kg

15 Judoka

POOL A

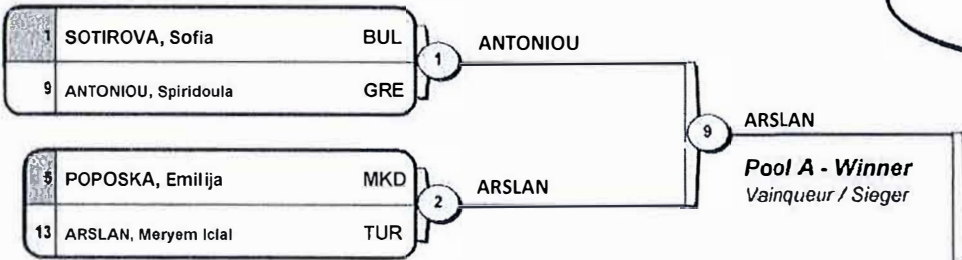

POOL B

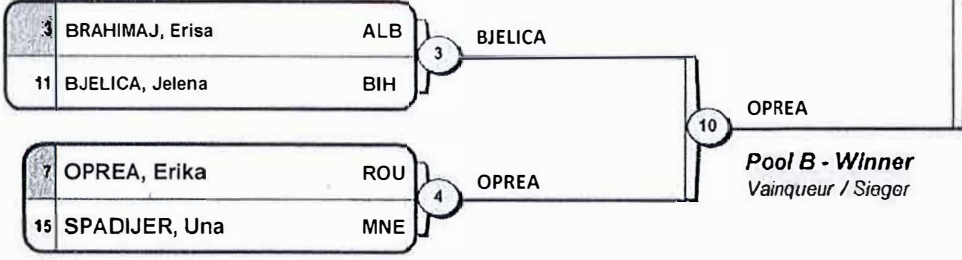

POOL C

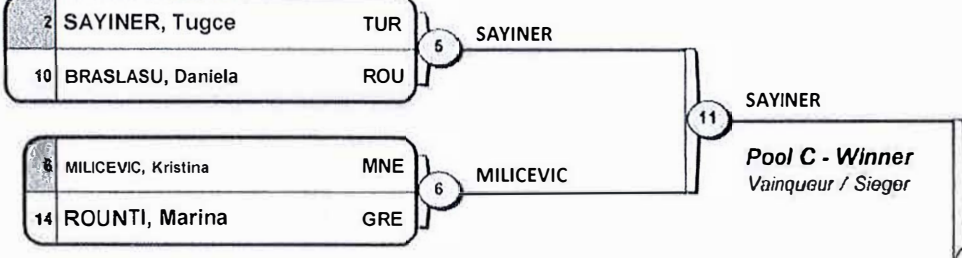

POOL D

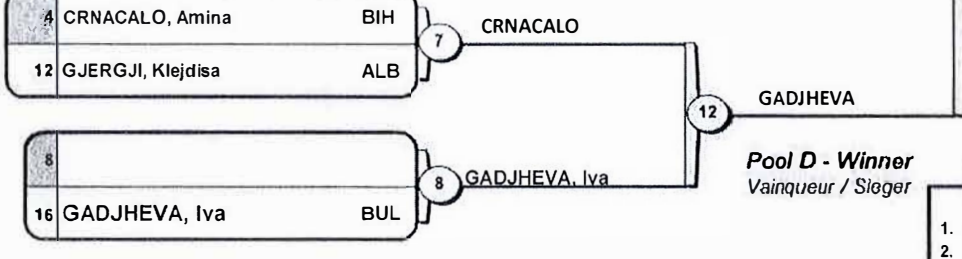

1.

- Results**  
Résultat / Platzierungen
1. ARSLAN, Meryem (Turkey)
  2. SAYINER, Tugce (Turkey)
  3. SPADIJER, Una (Montenegro)
  3. MILICEVIC, Kristina (Montenegro)
  5. GADJHEVA, Iva (Bulgaria)
  5. OPREA, Erica (Romania)
  7. POPOSKA, Emilija (Macedonia)
  7. CRNCALO, Amina (BiH)

Repechage / Trostrunde

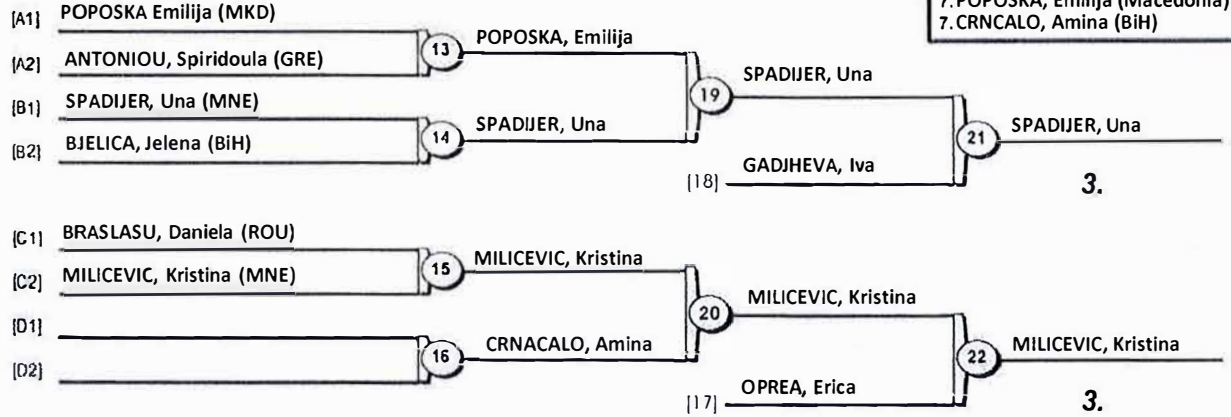

BALKAN JUDO ASSOCIATION  
Deniz Sili  
General Secretary

# BALKAN CHAMPIONSHIP U15

Niksic (MNE), 07-08 Jul 2018

## -52 kg

13 Judoka

POOL A

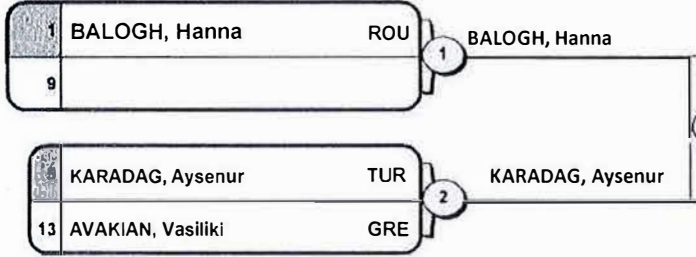

POOL B

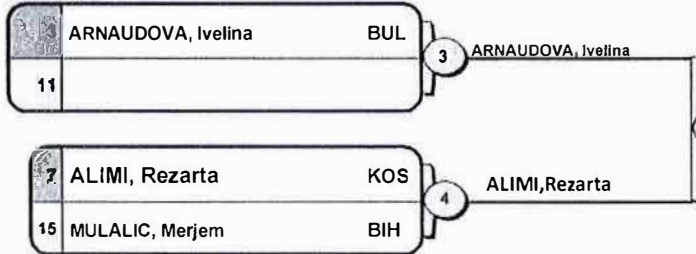

POOL C

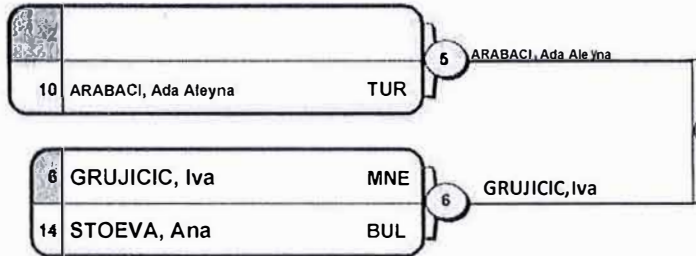

POOL D

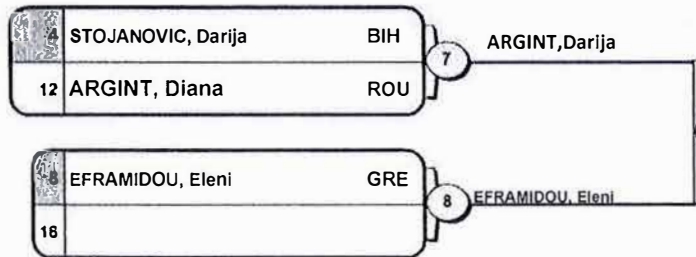

KARADAG, Aysenur

1.

18 ARGINT, Diana

### Results

Résultat / Platzierungen

1. KARADAG, Aysenur (Turkey)
2. ARGINT, Diana (Romania)
3. MULALIC, Merjem (BIH)
3. STOJANOVIC, Darija (BIH)
5. GRUJICIC, Iva (Montenegro)
5. ALIMI, Rezarta (Kosovo)
7. AVAKIAN, Vasiliki (GRE)
7. ARABACI, Ada Aleyna (TUR)

Repechage / Trostrunde

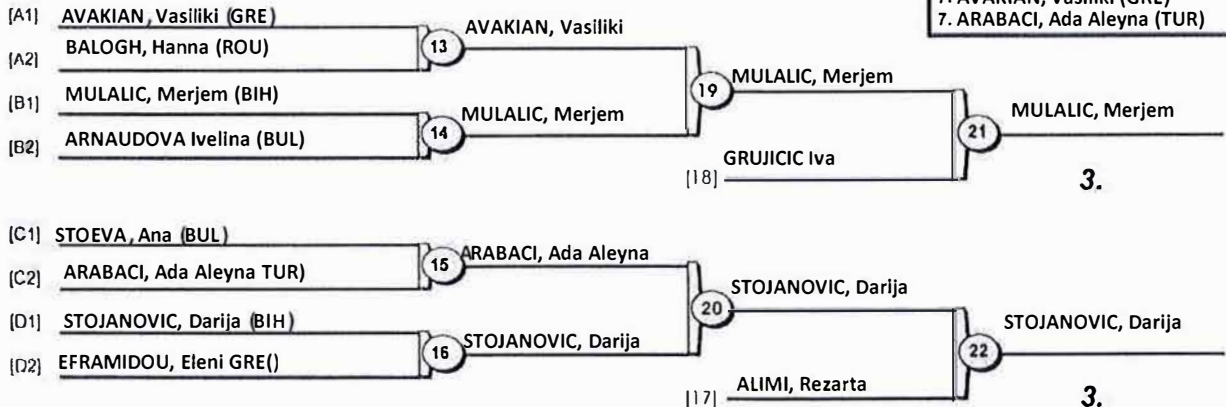

BALKAN JUDO ASSOCIATION  
Deniz PILLI  
General Secretary



# BALKAN CHAMPIONSHIP U15

Niksic (MNE), 07-08 Jul 2018

## -57 kg

13 Judoka

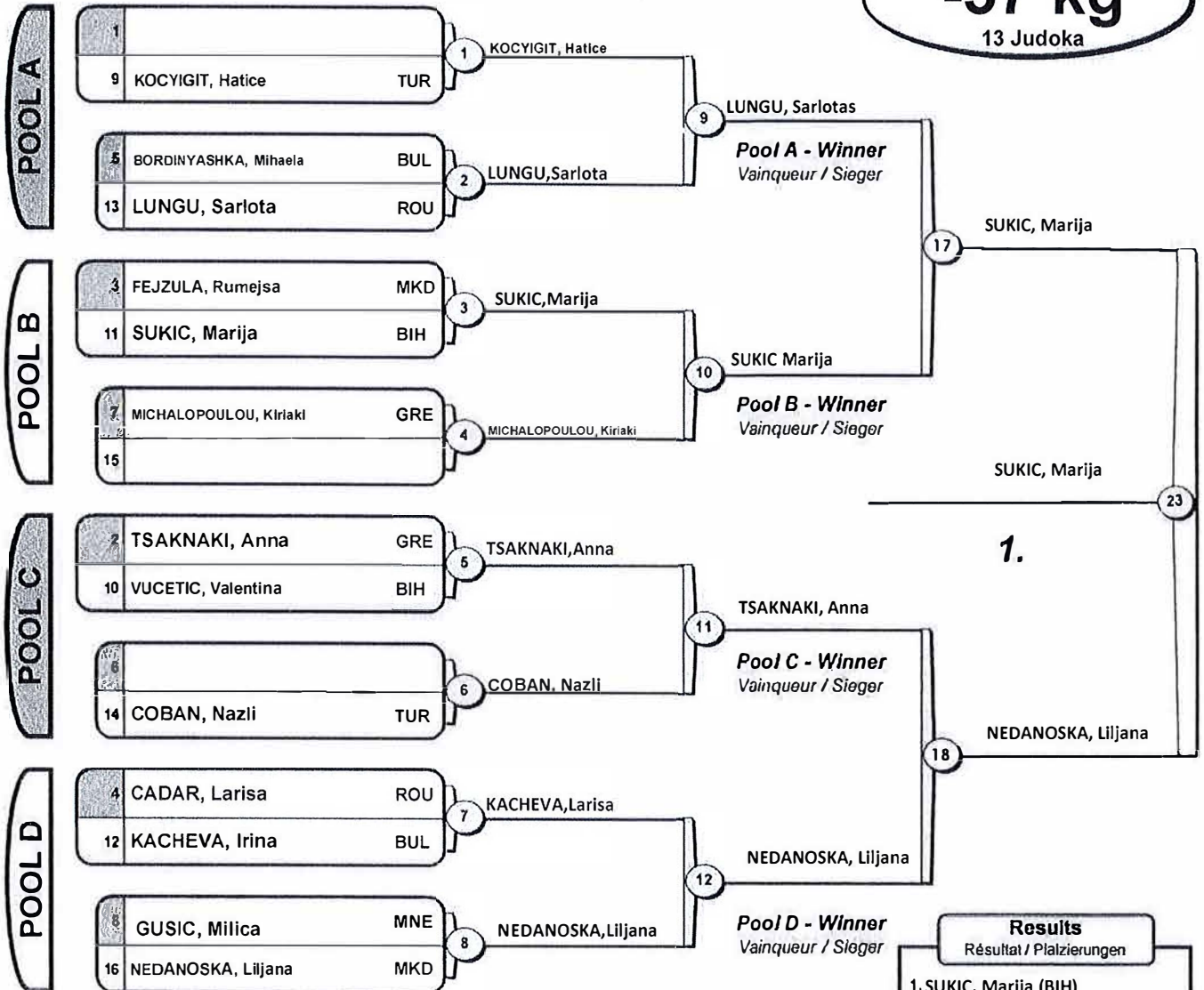

1.

### Results

Résultat / Platzierungen

1. SUKIC, Marija (BIH)
2. NEDANOSKA, Liljana (MKD)
3. KOCYIGIT, Hatice (Turkey)
4. LUNGU, Sarlota (Romania)
5. TSAKNAKI, Anna (Greece)
6. KACHEVA, Irina (Bulgaria)
7. MICHALOPOULOU, Kiriaki (GRE)
8. COBAN, Nazli (Turkey)

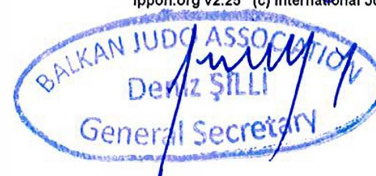
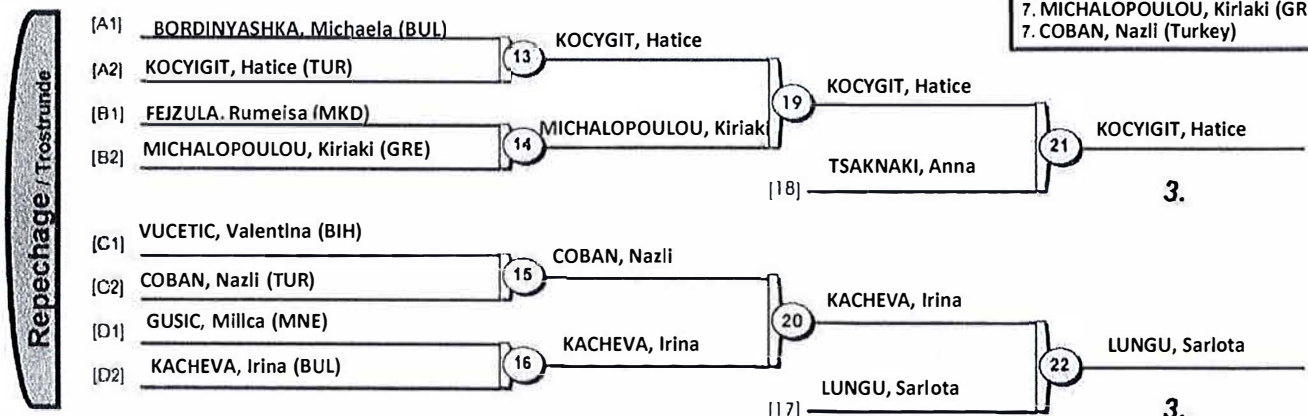

# BALKAN CHAMPIONSHIP U15

Niksic (MNE), 07-08 Jul 2018

## -63 kg

11 Judoka

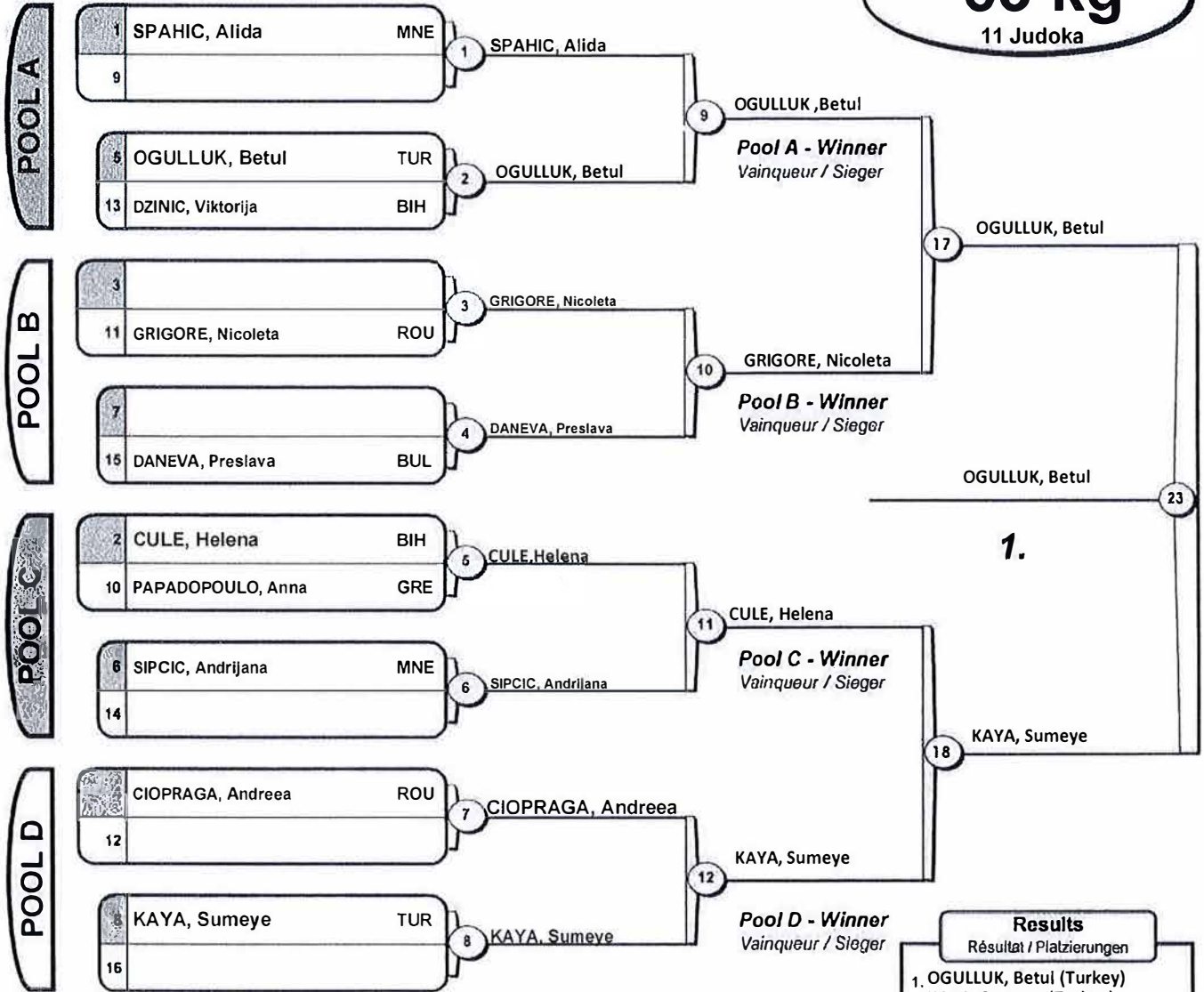

### Results

Résultat / Platzierungen

- OGULLUK, Betul (Turkey)
- KAYA, Sumeye (Turkey)
- DZINIC, Viktorija (BIH)
- GRIGORE, Nicoleta (Romania)
- CULE, Helena (BIH)
- CIORAGA, Andrea (Romania)
- DANEVA, Preslava (Bulgaria)
- PAPADOPOULO, Anna (GRE)

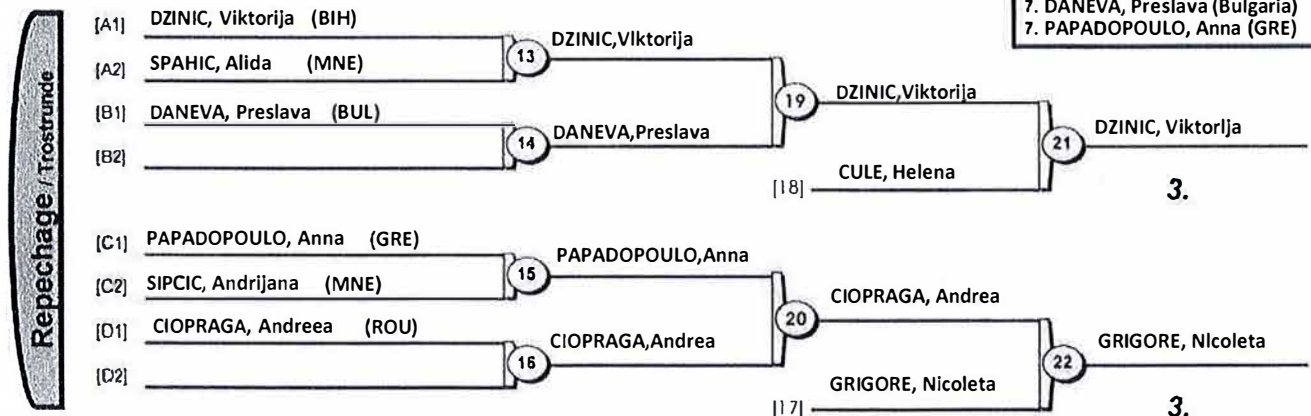

# BALKAN CHAMPIONSHIP U15

Niksic (MNE), 07-08 Jul 2018

## +63 kg

11 Judoka

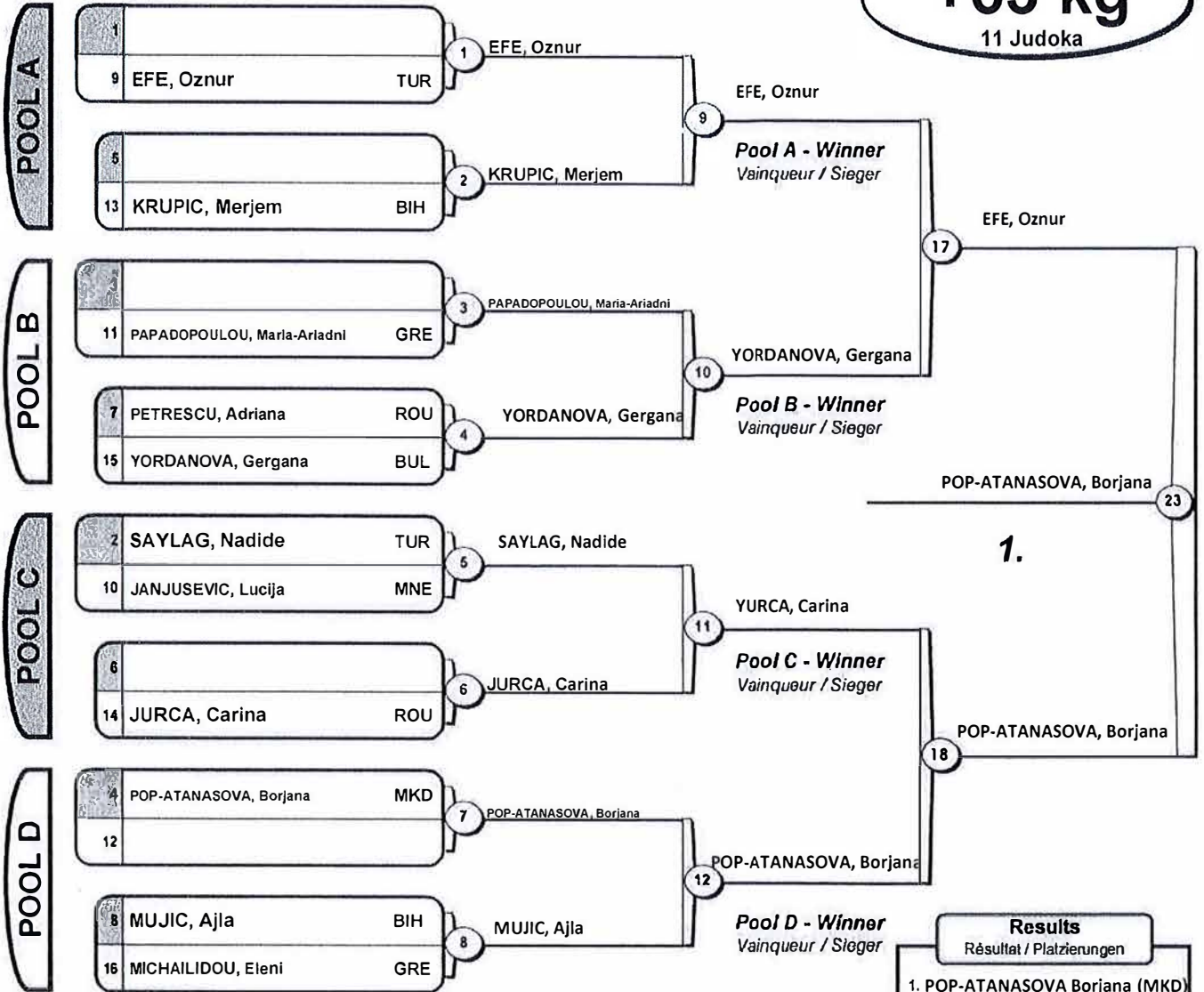

1.

- Results**  
Résultat / Platzierungen
1. POP-ATANASOVA Borjana (MKD)
  2. EFE, Oznur (Turkey)
  3. JURCA, Carina (Romania)
  3. SAYLAG, Nahide (Turkey)
  5. PETRESCU, Adriana (Romania)
  5. YORDANOVA, Gergana (BUL)
  7. KRUPIC, Merjem (BIH)
  7. MUJIC, Ajla (BIH)

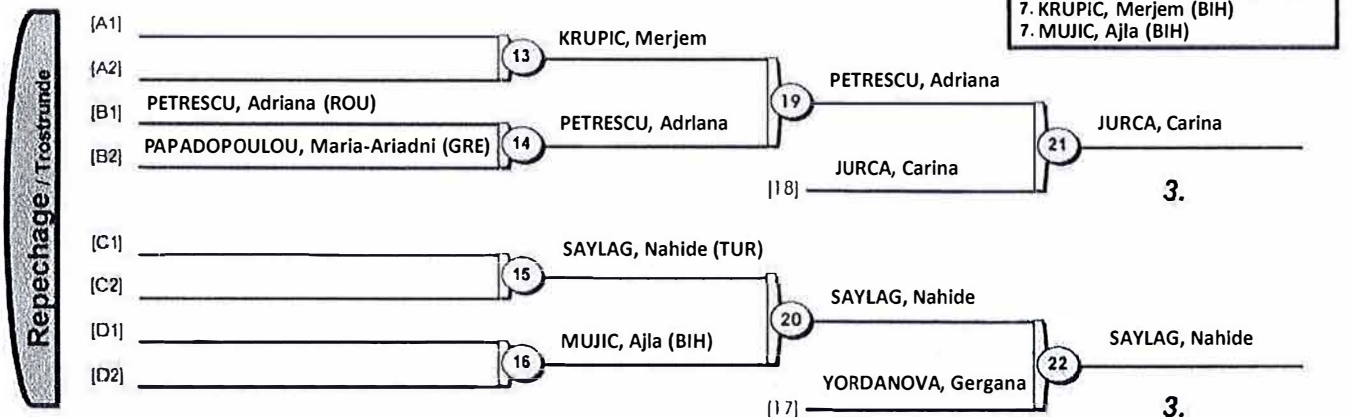

# BALKAN CHAMPIONSHIP U15

Niksic (MNE), 07-08 Jul 2018

## -34 kg

9 Judoka

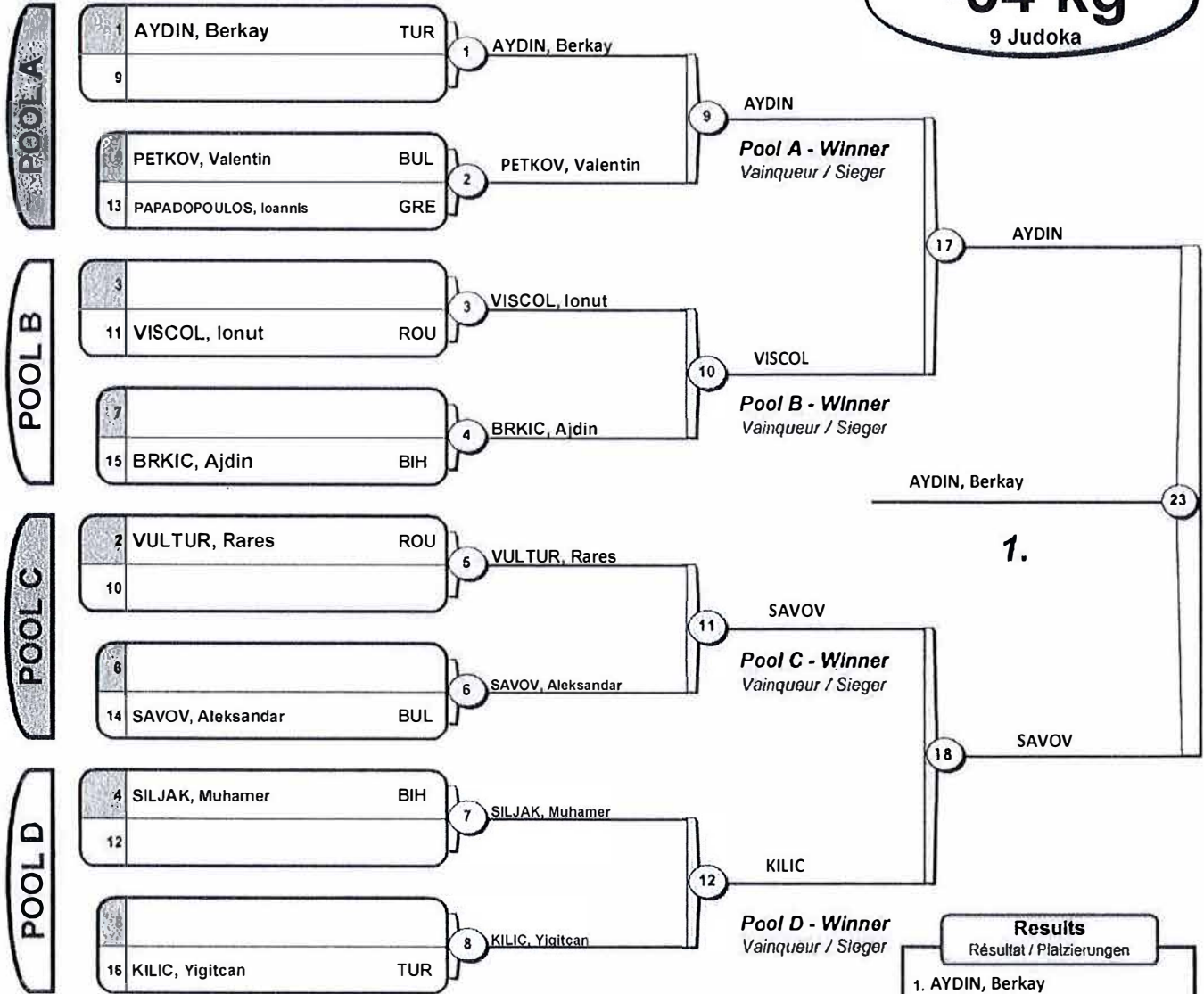

- Results**  
Résultat / Platzierungen
- AYDIN, Berkay
  - SAVOV, Aleksandar
  - PETKOV, Valentin (Bulgaria)
  - VISCOL Ionut (Romania)
  - KILIC Yigitcan (Turkey)
  - VULTUR Rares (Romania)
  - BRKIC Ajdin (Bosnia&Herzegovina)
  - Siljak Muhamer (Bosnia&Herzegovina)

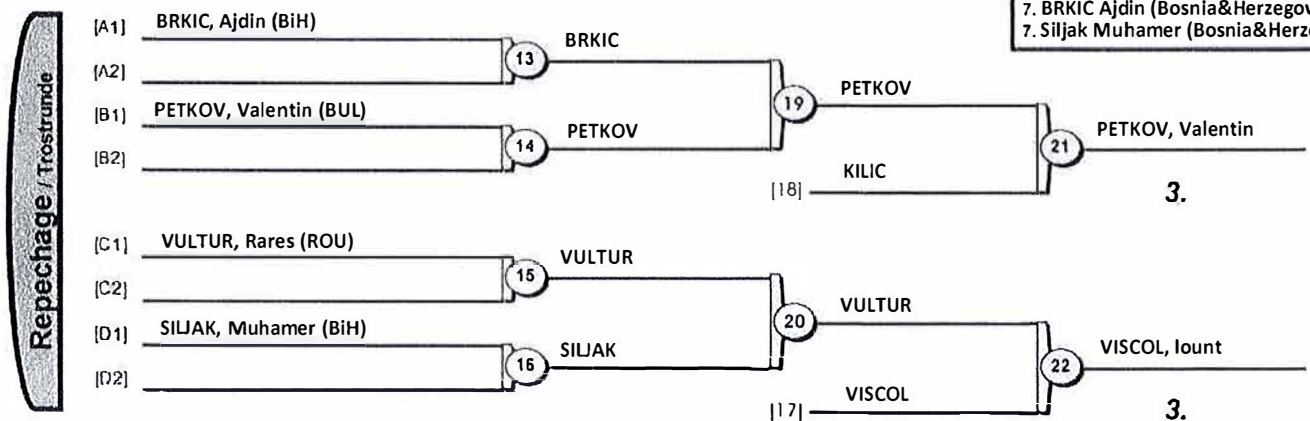

# BALKAN CHAMPIONSHIP U15

Niksic (MNE), 07-08 Jul 2018

**-38 kg**  
10 Judoka

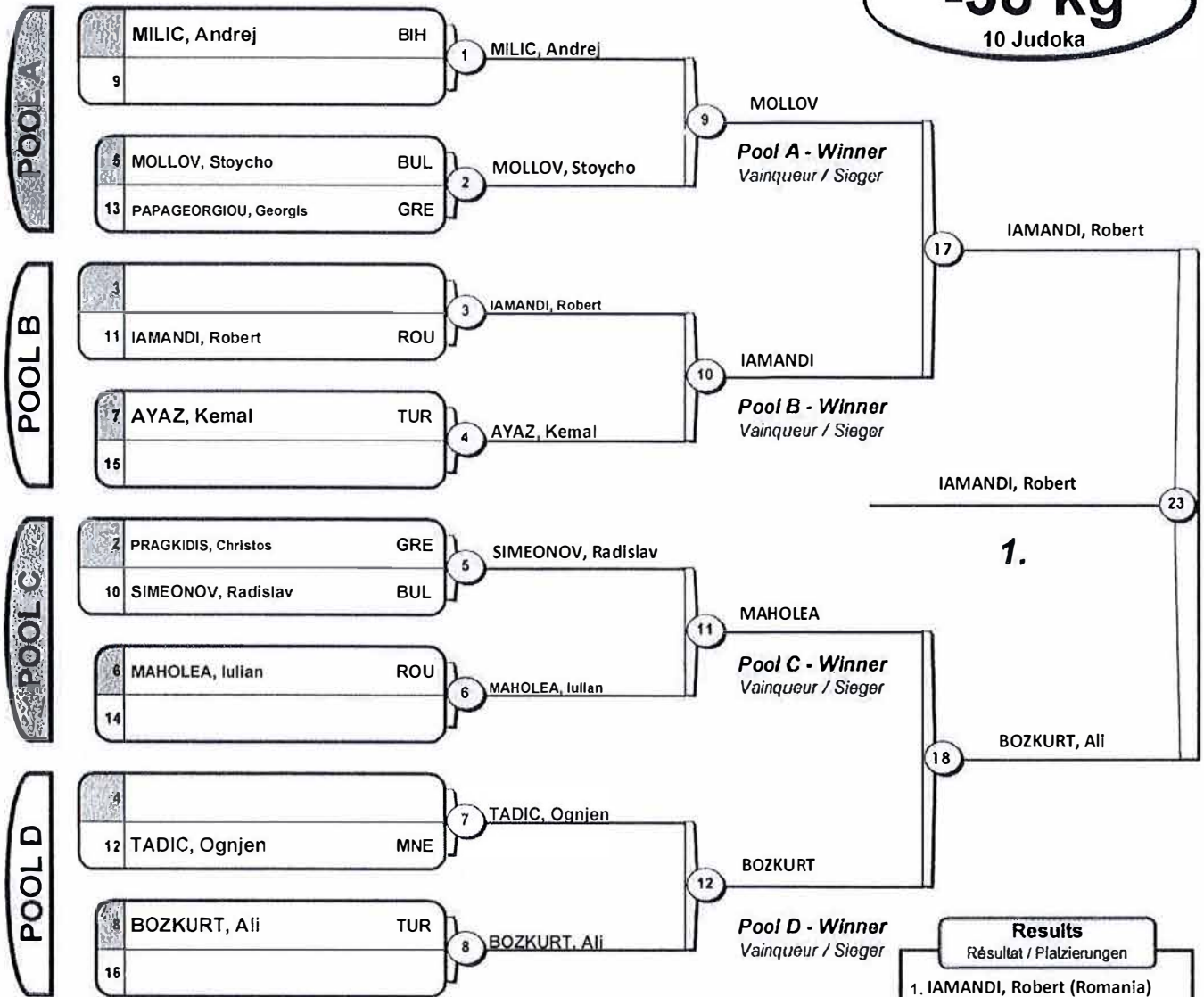

Results
Résultat / Platzierungen
1. IAMANDI, Robert (Romania)
2. BOZKURT, Ali (Turkey)
3. AYAZ, Kemal (Turkey)
3. MOLLOV, Stoycho (Bulgaria)
5. MAHOLEA, Iulian (Romania)
5. SIMEONOV, Radislav (Bulgaria)
7. MILIC, Andrej (BiH)
7. TADIC, Ognjen (Montenegro)

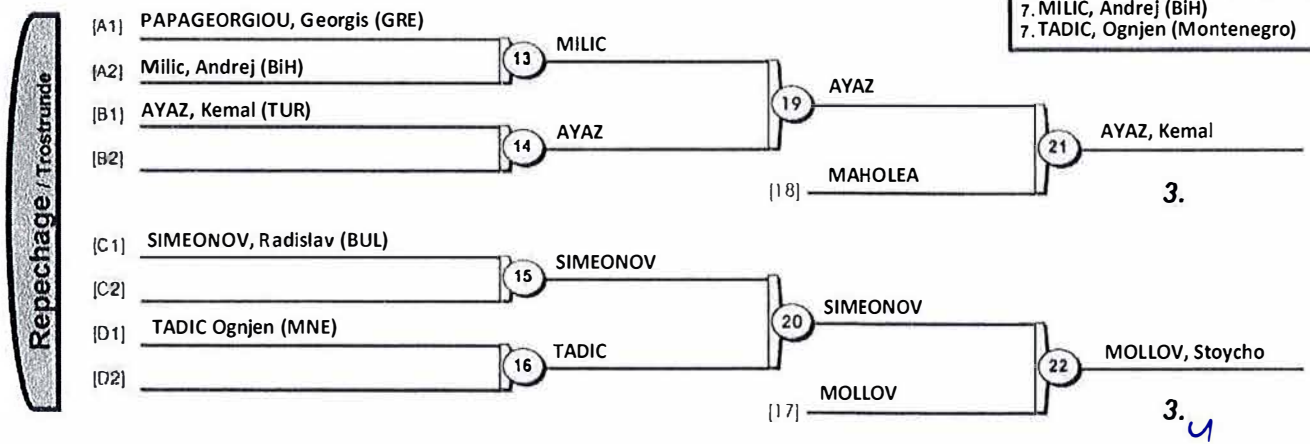

BALKAN JUDO ASSOCIATION  
DOMIZ ŠILJKI  
General Secretary

# BALKAN CHAMPIONSHIP U15

Nisic (MNE), 07-08 Jul 2018

## -42 kg

11 Judoka

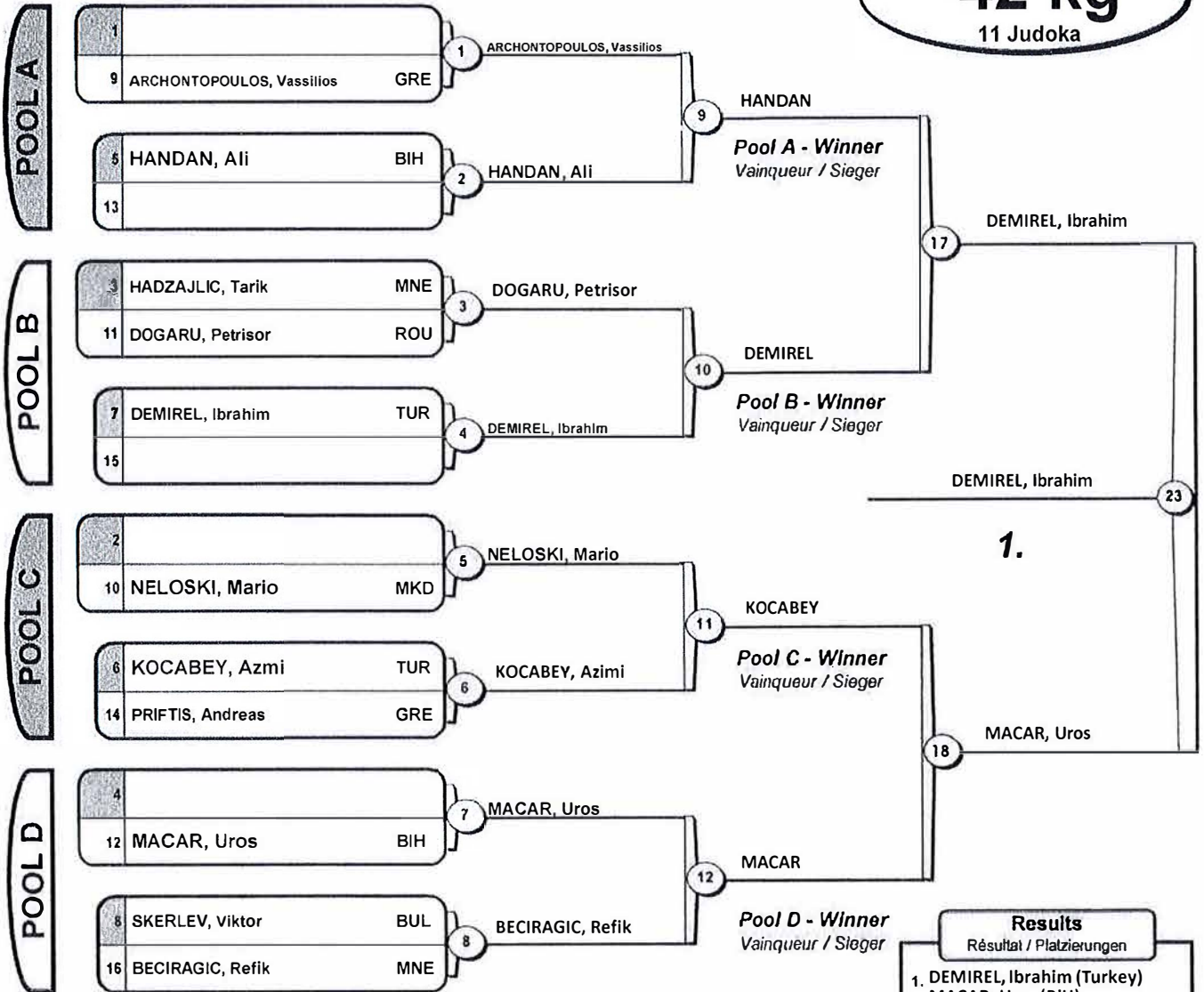

- Results**  
Résultat / Platzierungen
1. DEMIREL, Ibrahim (Turkey)
  2. MACAR, Uros (BiH)
  3. KOCABEY, Azmi (Turkey)
  3. BECIRAGIC, Refik (Montenegro)
  5. DOGARU, Petrisor (Romania)
  5. HANDAN, Ali (BiH)
  7. ARCHONTOPOULOS, Vassilios (GRE)
  7. NELOSKI, Mario (Macedonia)

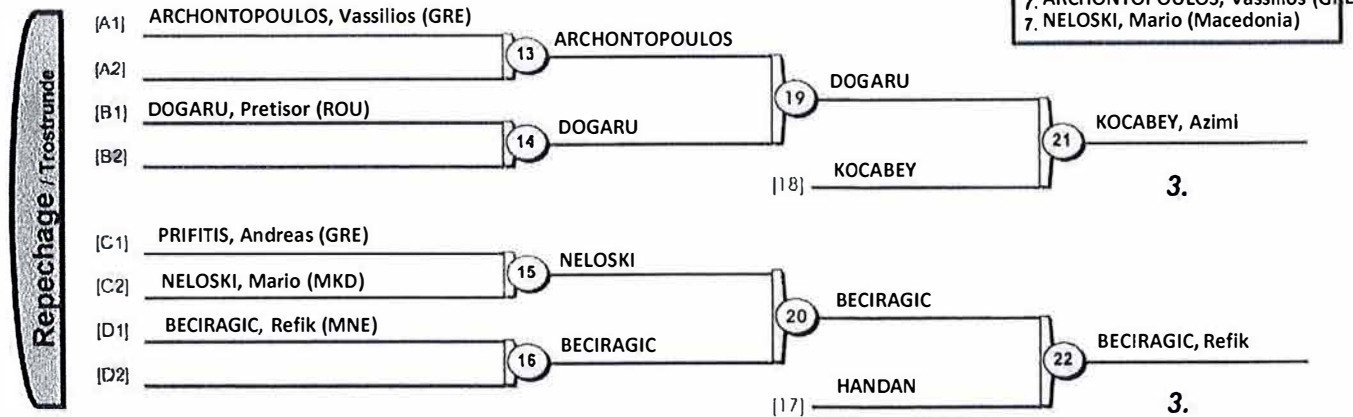

BALKAN JUDO ASSOCIATION  
Daniz ŠILJA  
General Secretary

# BALKAN CHAMPIONSHIP U15

Niksic (MNE), 07-08 Jul 2018

## -46 kg

12 Judoka

POOL A

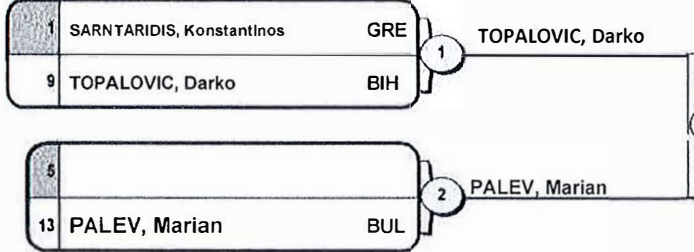

**Pool A - Winner**  
Vainqueur / Sieger

POOL B

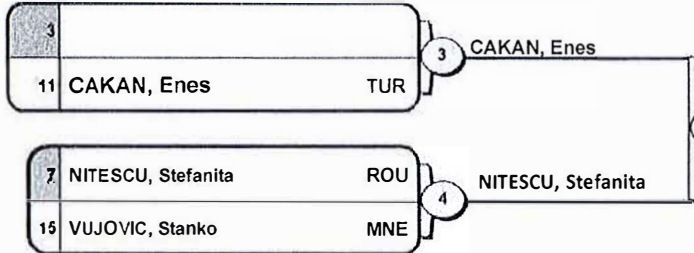

**Pool B - Winner**  
Vainqueur / Sieger

POOL C

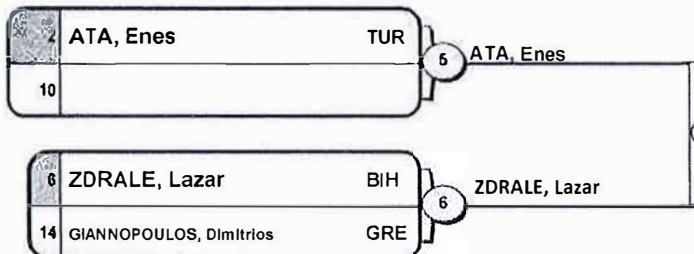

**Pool C - Winner**  
Vainqueur / Sieger

POOL D

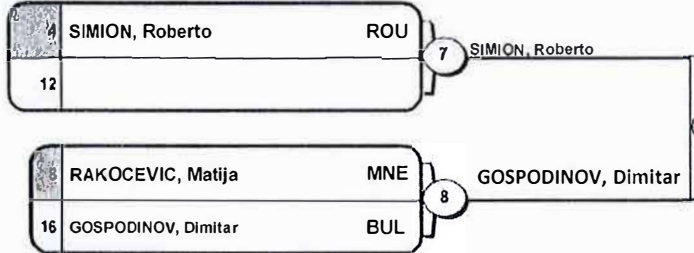

**Pool D - Winner**  
Vainqueur / Sieger

CAKAN, Enes

1.

ATA, Enes

### Results

Résultat / Platzierungen

1. CAKAN, Enes (Turkey)
2. ATA, Enes (Turkey)
3. NITESCU, Stefanita (Romania)
3. GOSPODINOV, Dimitar (Bulgaria)
5. SIMION, Roberto (Romania)
5. PALEV Marian (Bulgaria)
7. TOPALOVIC, Darko (BIH)
7. ZDRALE, Lazar (BIH)

Repechage / Trostrunde

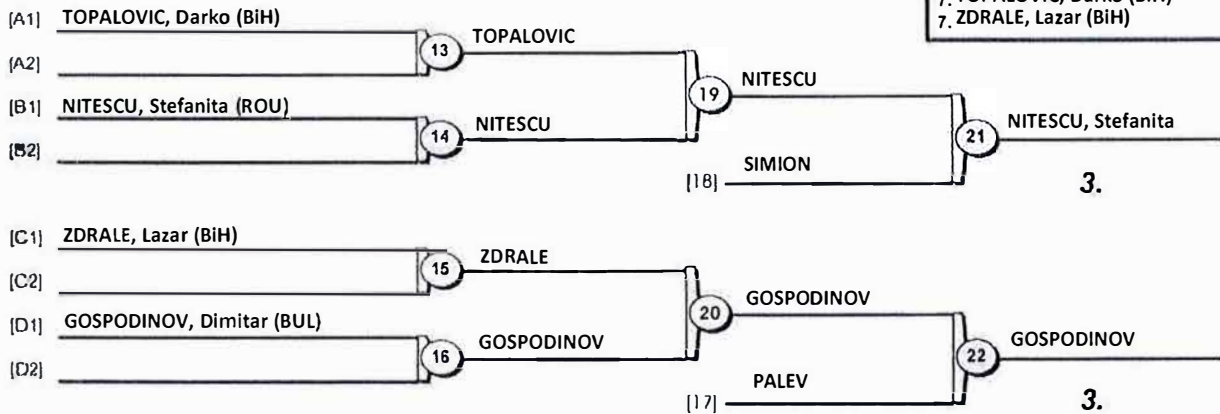

# BALKAN CHAMPIONSHIP U15

Niksic (MNE), 07-08 Jul 2018

## -50 kg

13 Judoka

POOL A

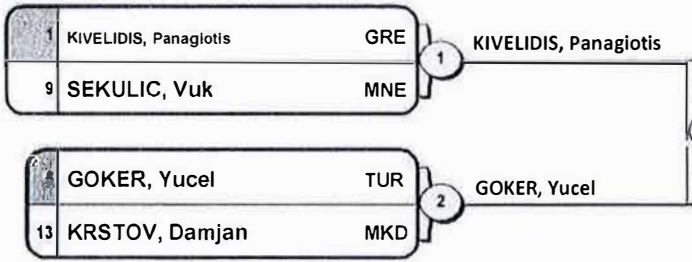

KIVELIDIS

**Pool A - Winner**  
Vainqueur / Sieger

POOL B

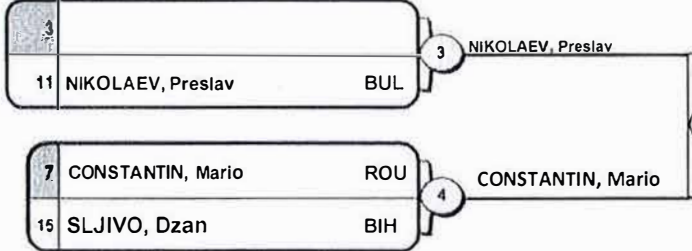

CONSTANTIN

**Pool B - Winner**  
Vainqueur / Sieger

CONSTANTIN, Mario

SOTIROV, Dimitar

1.

POOL C

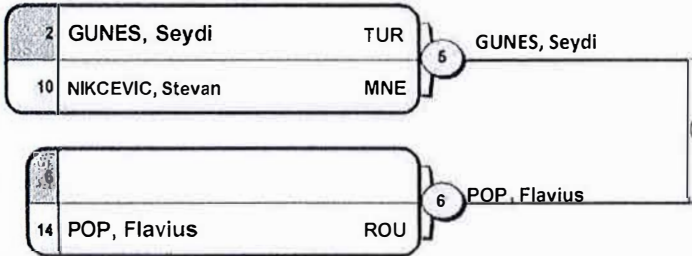

GUNES

**Pool C - Winner**  
Vainqueur / Sieger

SOTIROV, Dimitar

POOL D

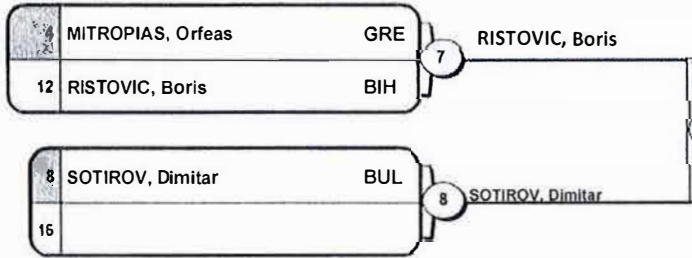

SOTIROV

**Pool D - Winner**  
Vainqueur / Sieger

### Results

Résultat / Platzierungen

1. SOTIROV, Dimitar (Bulgaria)
2. CONSTANTIN, Mario (Romania)
3. GOKER, Yucel (Turkey)
3. RISTOVIC, Boris (BiH)
5. GUNES, Seydi (Turkey)
5. KIVELIDIS, Panagiotis (Greece)
7. SLJIVO, Dzan (BiH)
7. NIKCEVIC, Stevan (Montenegro)

Repechage / Trostrunde

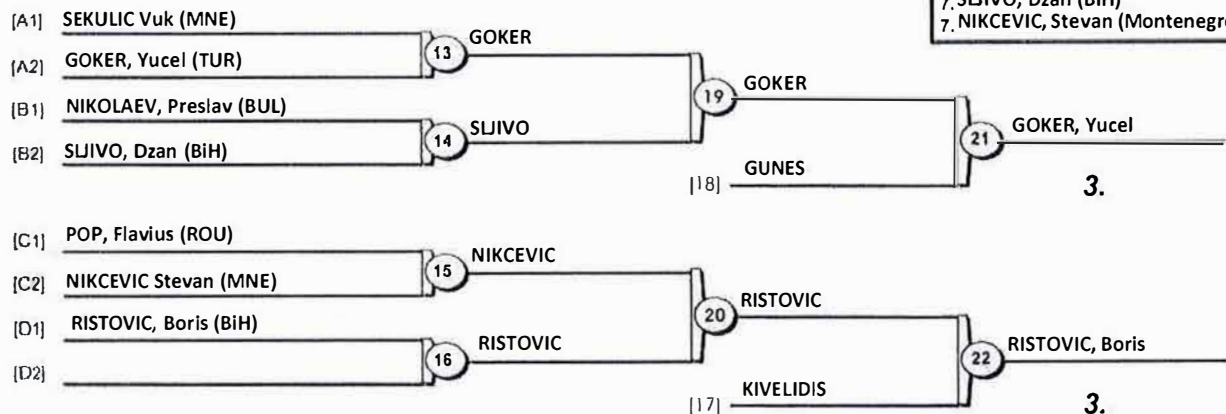

3.

U

BALKAN JUDO ASSOCIATION  
Deniz ŞILLI  
General Secretary



# BALKAN CHAMPIONSHIP U15

Niksic (MNE), 07-08 Jul 2018

## -55 kg

10 Judoka

POOL A

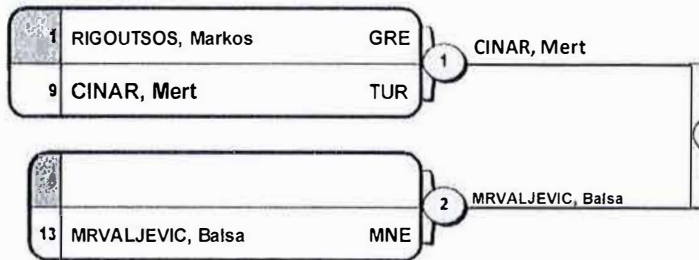

MRVALJEVIC, Balsa

**Pool A - Winner**  
Vainqueur / Sieger

POOL B

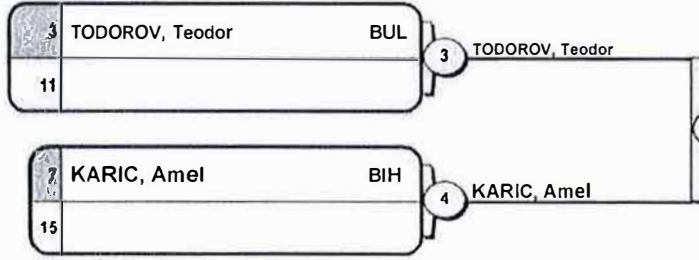

TODOROV, Teodor

**Pool B - Winner**  
Vainqueur / Sieger

POOL C

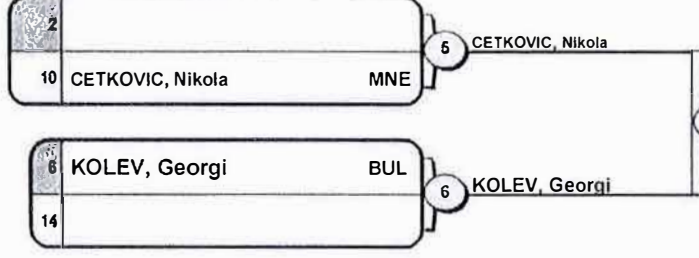

KOLEV, Georgi

**Pool C - Winner**  
Vainqueur / Sieger

POOL D

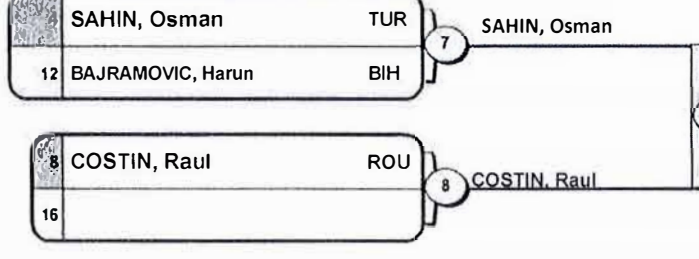

COSTIN, Raul

**Pool D - Winner**  
Vainqueur / Sieger



1.

- Results**  
Résultat / Platzierungen
- MRVALJEVIC, Balsa (Montenegro)
  - KOLEV, Georgi
  - COSTIN, Raul (Romania)
  - TODOROV, Teodor (Bulgaria)
  - CINAR, Mert (Turkey)
  - SAHIN, Osman (Turkey)
  - KARIC, Amel (BiH)
  - CETKOVIC, Nikola (Montenegro)

Repechage / Trostrunde

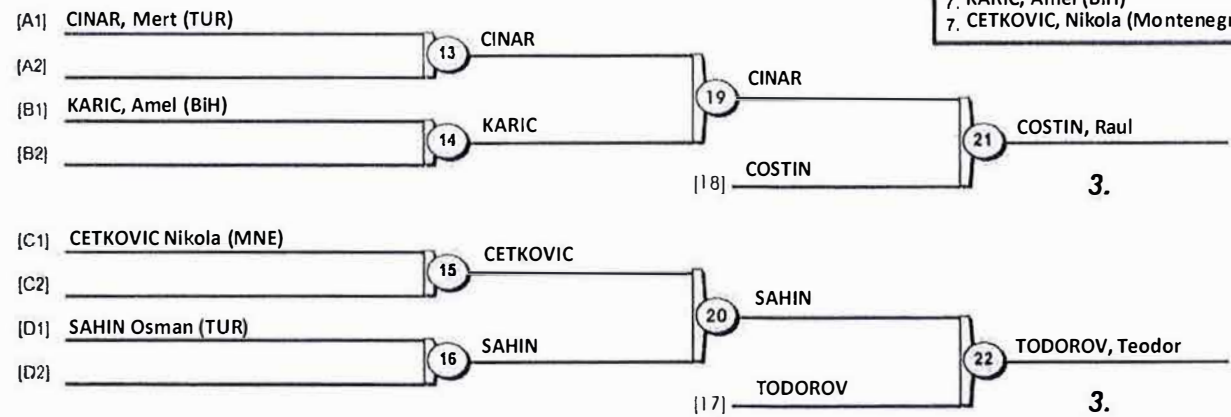

3.

3.



# BALKAN CHAMPIONSHIP U15

Niksic (MNE), 07-08 Jul 2018

## -60 kg

10 Judoka

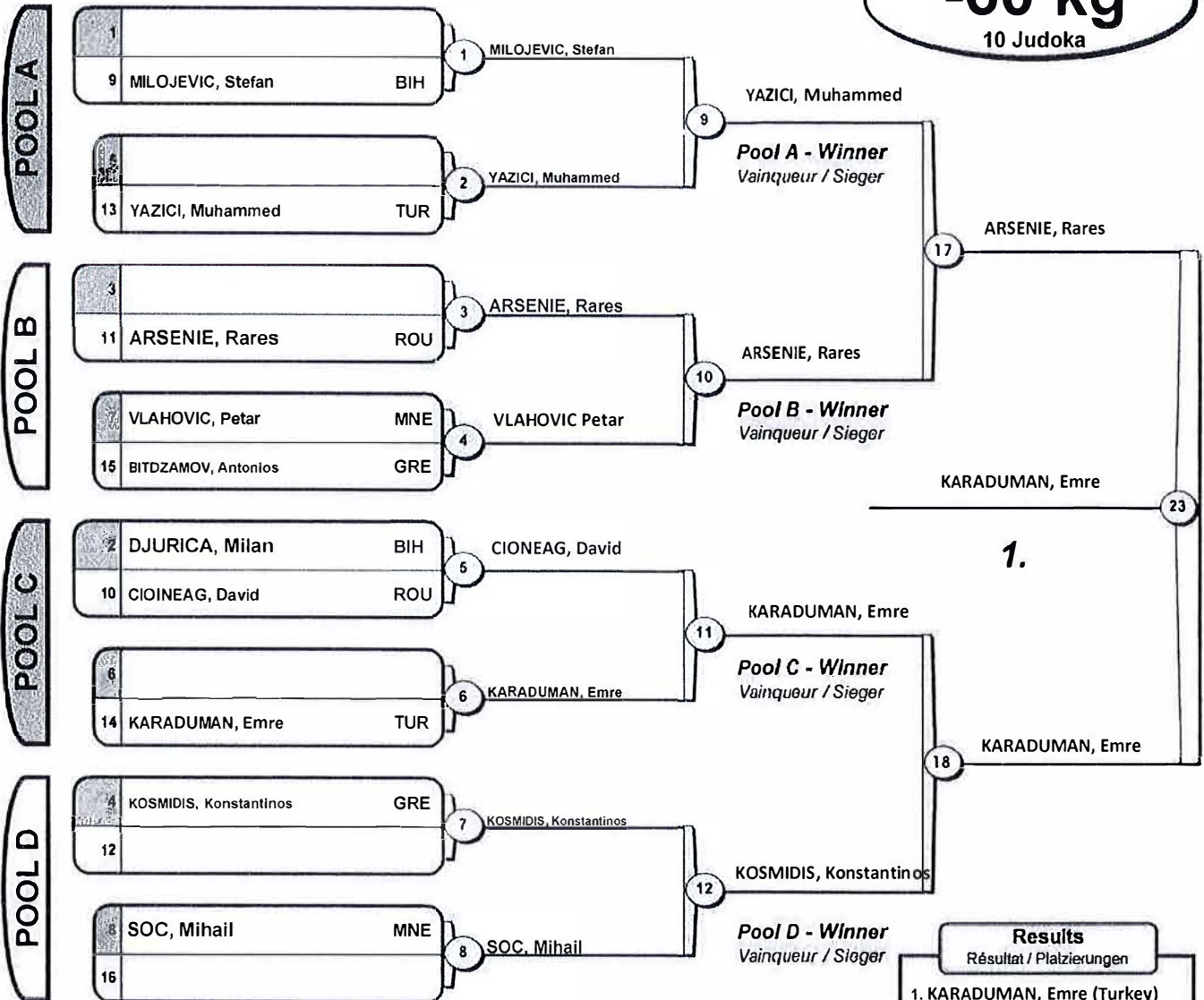

- Results**  
Résultat / Platzierungen
1. KARADUMAN, Emre (Turkey)
  2. ARSENIE, Rares (Romania)
  3. KOSMIDIS, Konstantinos (GRE)
  3. YAZICI, Muhammed (Turkey)
  5. MILOJEVIC, Stefan (BIH)
  5. CIONEAG, David (Romania)
  7. VLAHOVIC, Petar (Montenegro)
  7. SOC, Mihail (Montenegro)

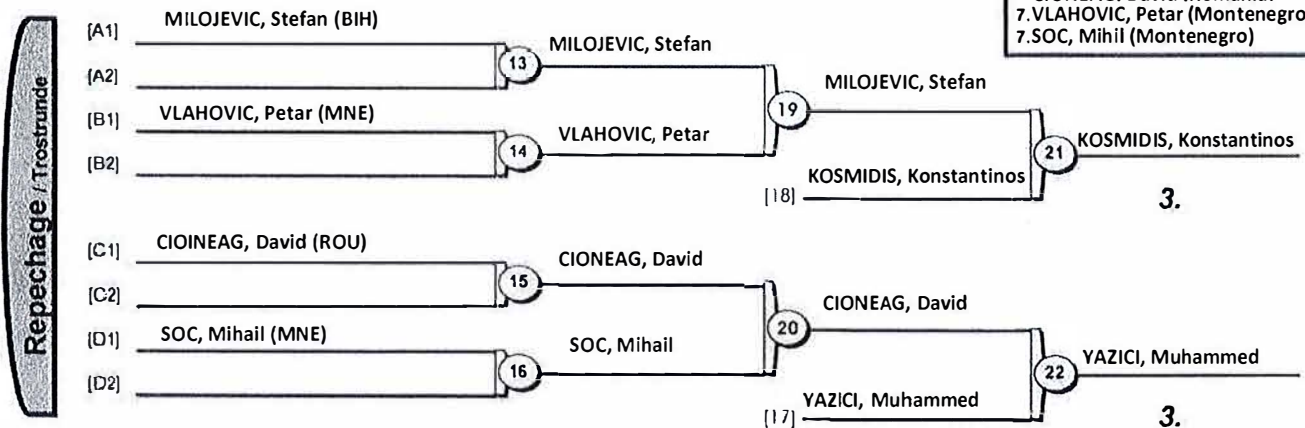

# BALKAN CHAMPIONSHIP U15

Niksic (MNE), 07-08 Jul 2018

## -66 kg

12 Judoka

POOL A



POOL B



POOL C

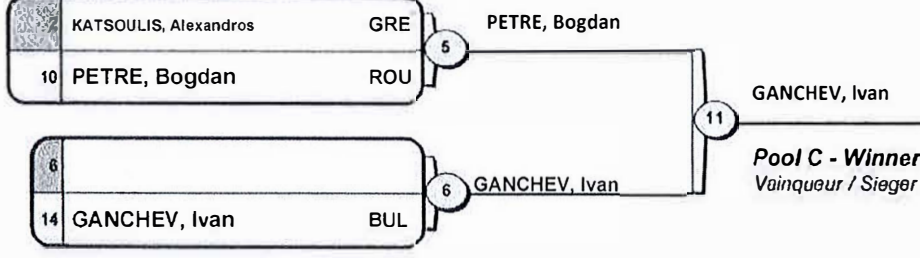

POOL D

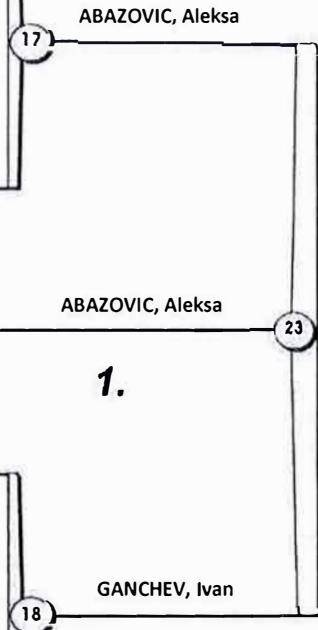
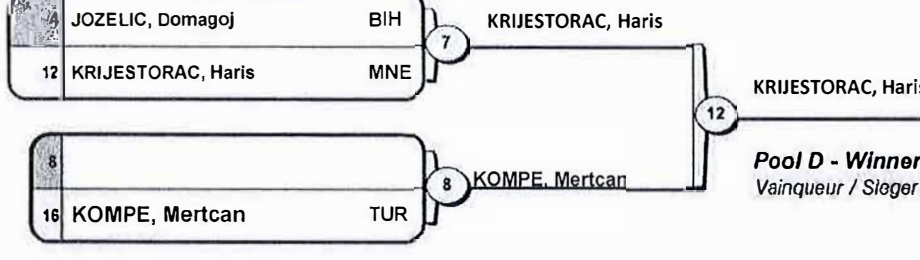

1.

- Results**  
Résultat / Platzierungen
1. ABAZOVIC, Aleksa (Montenegro)
  2. GANCHEV, Ivan (Bulgaria)
  3. BAYRAKTAR, Metehan (TUR)
  4. MALJEVIC, Vidak (BIH)
  5. KRIJESTORAC, Haris (MNE)
  6. PETRE, Bogdan (Romania)
  7. GARMACEA, Rares (Romania)
  8. KOMPE, Mertcan (Turkey)

Repechage / Trostrunde

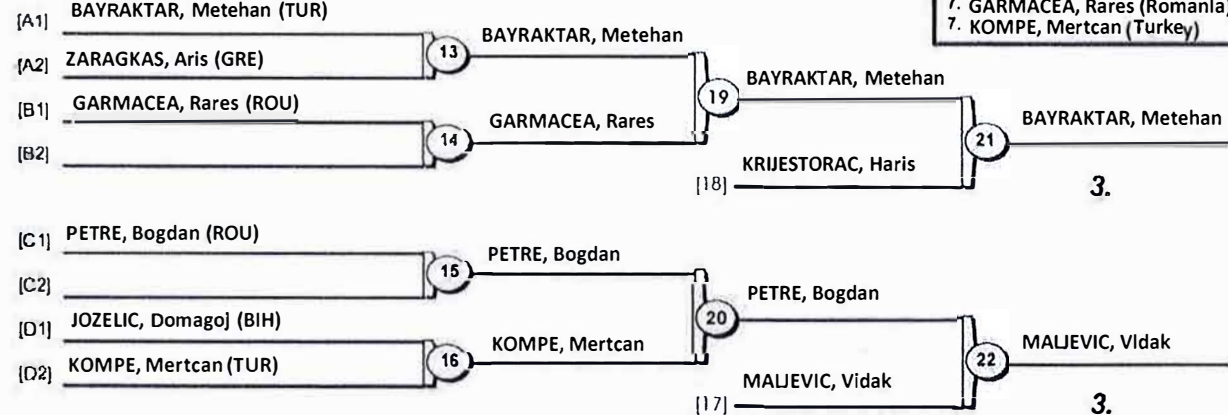

Deniz ŞİLİ  
General Secretary

# BALKAN CHAMPIONSHIP U15

Niksic (MNE), 07-08 Jul 2018

## -73 kg

12 Judoka

POOL A

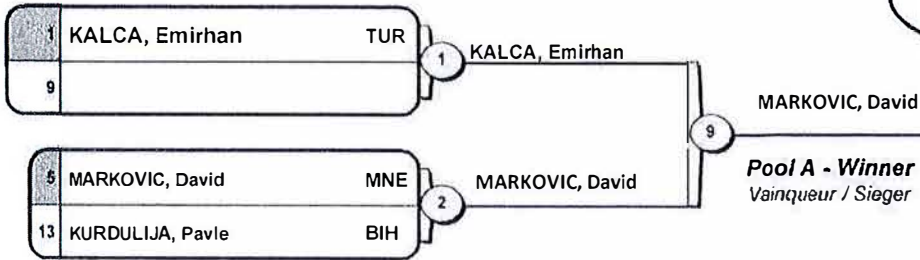

POOL B

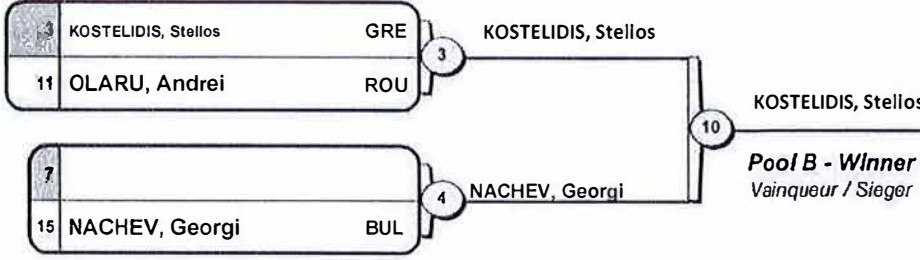

POOL C

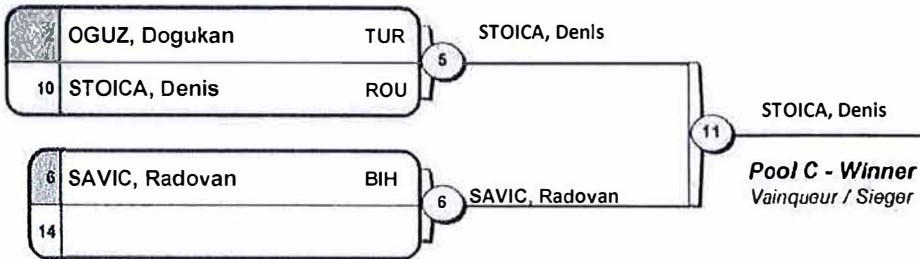

POOL D

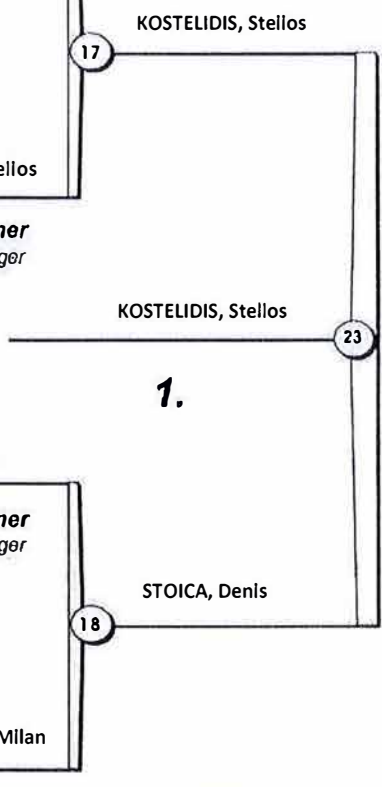
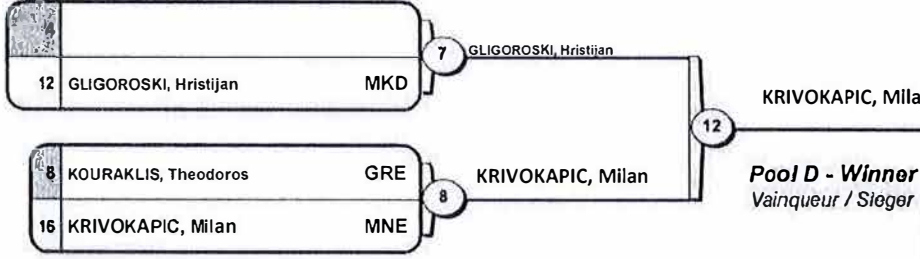

- Results**  
Résultat / Platzierungen
1. KOSTELIDIS, Stellos (Greece)
  2. STOICA, Denis (Romania)
  3. KRIVOKAPIC, Milan (MNE)
  3. MARKOVIC, David (MNE)
  5. OLARU, Andrei (ROM)
  5. SAVIC, Radovan (BIH)
  7. KURDULIJA, Pavle (BIH)
  7. KOURAKLIS, Theodoros (GRE)

Repechage / Trostrunde

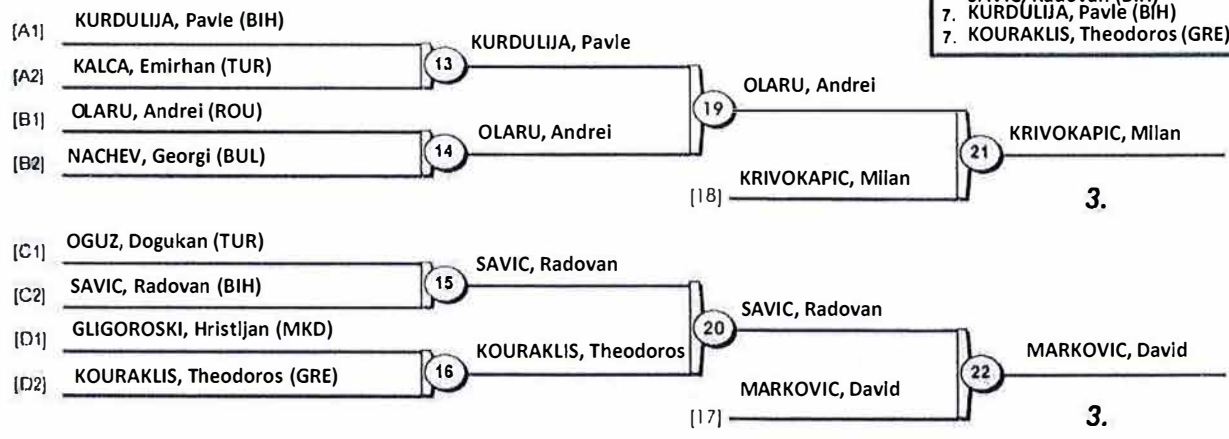

# BALKAN CHAMPIONSHIP U15

Niksic (MNE), 07-08 Jul 2018

## +73 kg

12 Judoka

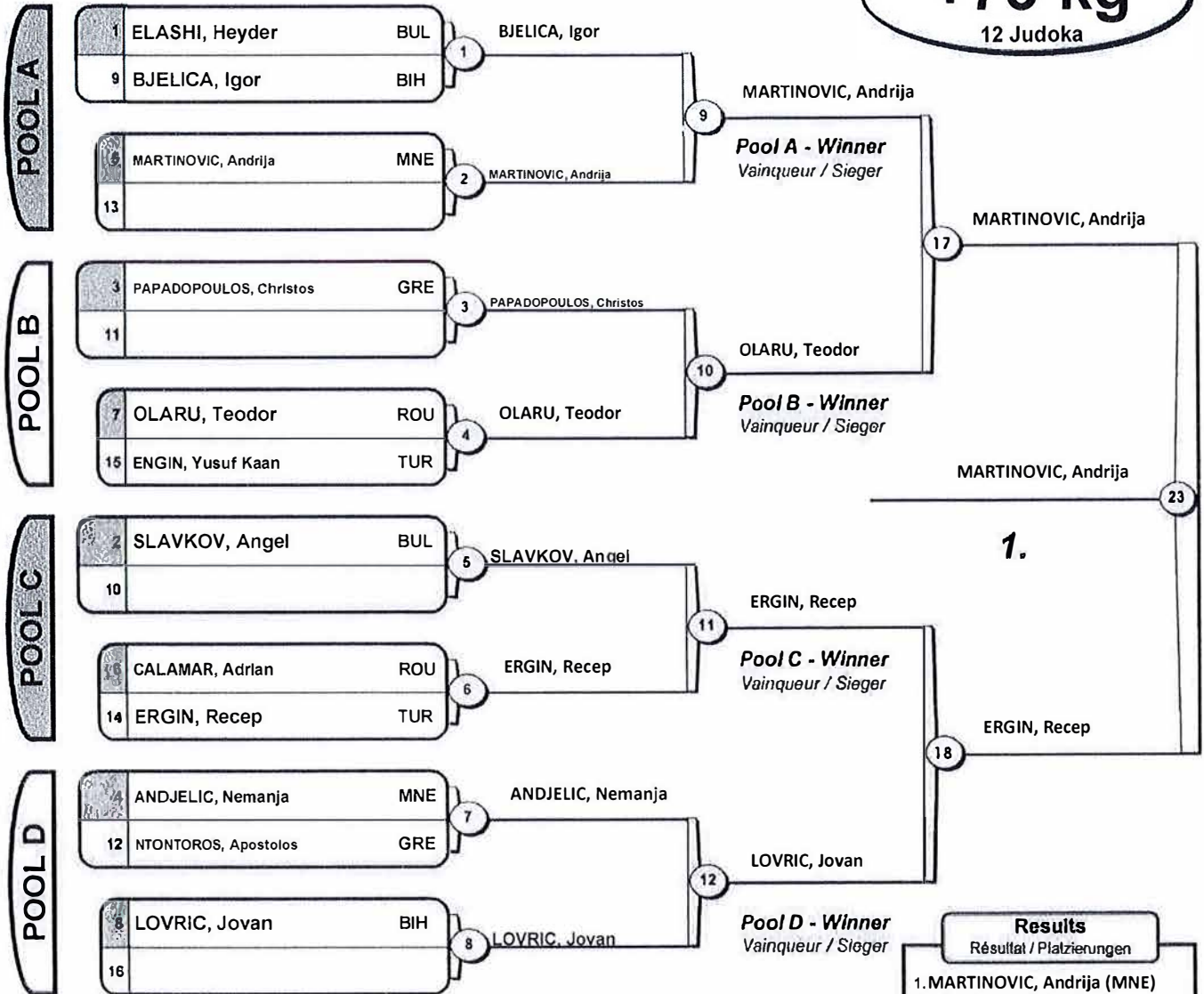

- Results**  
Résultat / Platzierungen
- MARTINOVIC, Andrija (MNE)
  - ERGIN, Recep (Turkey)
  - BJELICA, Igor (BIH)
  - OLARU, Teodor (Romania)
  - LOVRIC, Jovan (BIH)
  - CALAMAR, Adrian (Romania)
  - ENGIN, Yusuf Kaan (Turkey)
  - ANDJELIC, Nemanja (Montenegro)

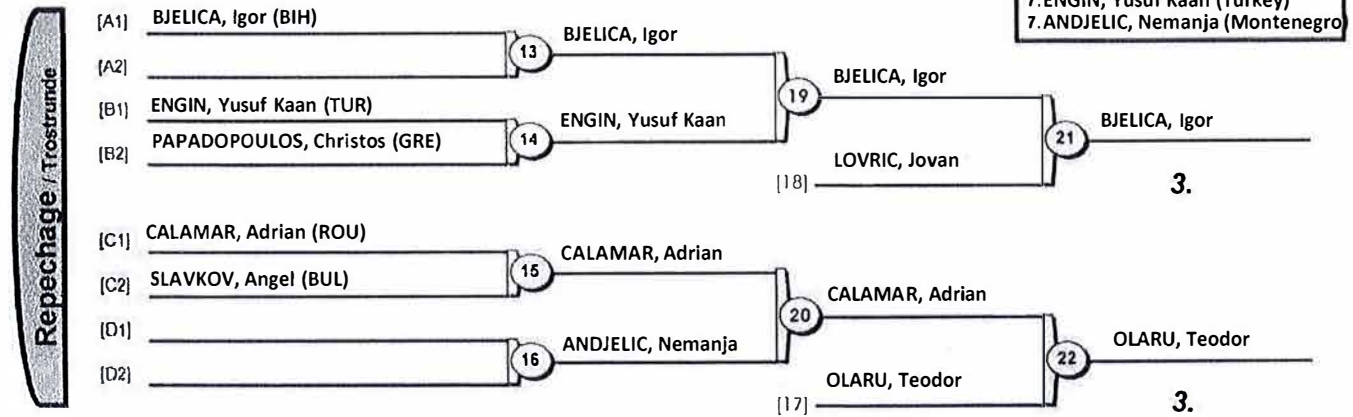

*peniz*  
BALKAN JUDO ASSOCIATION  
peniz S.Li  
General Secretary